

Panasonic

ideas for life

LCD Monitor Line-up Catalog



NEW BT-LH2550
25.5" LCD HD/SD Monitor



NEW BT-LH1710
17" Wide LCD HD/SD Monitor

BT-LH80WU
7.9" Wide LCD HD/SD Monitor

BT-LH900A
8.4" LCD HD/SD Monitor

BT-LH1760
17" Wide LCD HD/SD Monitor

Panasonic Profess



Panasonic's professional LCD video monitors feature compact, energy-efficient LCD panels with faithful color reproduction, fast image appearance, and a long list of functions to meet professional needs.

BT-LH2550

NEW

Wide Color Space

This compact 25.5-inch monitor offers a wide color space and 1920 x 1200-pixel resolution. Ideal for use in post-production and in applications such as filmmaking, Computer Graphics, printing and research.

- A wider color space than CRT models, and new color space modes — Adobe gamma 1.8, Adobe gamma 2.2 and D-Cinema gamma 2.6.
- Wide, 178° horizontal and vertical viewing angles.
- Built-in calibration function.
- New 2-input Split-Screen function.
- Three-dimensional LUT offering virtually the same color reproduction as CRTs in all video formats.
- Advanced image-enhancing circuitry, including excellent motion response and a diagonal line compensation circuit.
- Various marker, cross hatch overlay and blue-only display functions.
- Vector scope and waveform monitoring.
- Time code display with HD-SDI input.
- Closed caption display with VIDEO (NTSC) input.
- Cine-gamma (F-REC) compensation for Varicam shooting.
- Audio level meter overlay display with SDI input.
- New unit design with slim frame for space-saving installation.
- Two SDI (HD/SD), component and DVI-D inputs, RGB input compatible.
- RS-232C/GPI remote control terminals.
- Tally lamp (red, green).
- Headphone jack.
- Quiet operation without fan noise.
- Also operates on AC power (AC adaptor included).
- Wall mountable (with optional BT-WMA26G).

BT-LH1760

Double Speed

Ideal for studio use, this model has double-speed drive and a new image processing engine for higher image quality. It also features a host of valuable functions that have been requested by our higher-end customers.

- Advanced image-enhancing circuitry, including excellent motion response and a diagonal line compensation circuit.
- Three-dimensional LUT offering virtually the same color reproduction as CRTs in all video formats.
- Double-speed drive displays moving images with minimal motion blurring.
- Wide, 176° horizontal and vertical viewing angle.
- Marker and blue-only functions.
- Vectorscope (SDI-In only) and waveform monitoring.
- Cross hatch overlay display.
- Pixel-to-pixel display without resizing HD pixels.
- Coordination of multiple cameras on split screens.
- Time code (HD-SDI only) and closed caption (NTSC) display.
- Cine-gamma (F-REC) compensation for Varicam shooting.
- Production-tough aluminum diecast frame build quality.
- Two SDI, component and DVI-D inputs, PC input compatible.
- RS-232C/GPI remote control terminals.
- Tally lamp (red, green)
- Headphone jack and built-in stereo speakers.
- Low power consumption and quiet operation without fan noise.
- Audio level meter overlay display (with SDI input).
- AC/DC power.
- Rack mounting (optional BT-MA1710G)
- Wall mounting (optional BT-WMA17G)
- LCD protective panel for outdoor use (optional BT-PRP17G)



ional LCD Monitor

With four screen sizes and five models to choose from, Panasonic monitors support broadcasting and image production tasks ranging from field recording with a camera-recorder to post-production and transmission.

BT-LH1710 **NEW**

This versatile, rack-mountable 17" wide-screen LCD operates on AC/DC power and can be used in various applications both in the studio and in the field.

- Advanced image-enhancing circuitry, including excellent motion response and a diagonal line compensation circuit.
- Three-dimensional LUT offering virtually the same color reproduction as CRTs in all video formats.
- Wide, 176° horizontal and vertical viewing angle.
- Marker and blue-only functions.
- Vectorscope (SDI-In only) and waveform monitoring.
- Cross hatch overlay display.
- Pixel-to-pixel display without resizing HD pixels.
- Coordination of multiple cameras on split screens.
- Time code (HD-SDI only) and closed caption (NTSC) display.
- Cine-gamma (F-REC) compensation for Varicam shooting.
- Production-tough aluminum diecast frame build quality.
- Two SDI, component and DVI-D inputs, PC input compatible.
- RS-232C/GPI remote control terminals.
- Tally lamp (red, green)
- Headphone jack and built-in stereo speakers.
- Low power consumption and quiet operation without fan noise.
- Audio level meter overlay display (with SDI input).
- AC/DC power
- Rack mounting (optional BT-MA1710G)
- Wall mounting (optional BT-WMA17G)
- LCD protective panel for outdoor use (optional BT-PRP17G)

BT-LH900A

This small, lightweight, 8.4" unit features a high-resolution LCD panel and is ideal for monitoring recordings, installation in broadcast and production vehicles, and many more uses.

- Broadcast-quality color and gradation.
- Wide, 170° horizontal and vertical viewing angle.
- Marker and blue-only functions.
- Waveform monitoring.
- Cine-gamma (F-REC) compensation for Varicam shooting.
- Thin, small and light for on-camera mounting.
- Versatile detached control panel.
- Production-tough aluminum diecast frame.
- HD/SD multi-format compatibility with two SDI and component inputs.
- RS-232C/GPI remote control terminals.
- Tally lamp (red, green)
- DC operation (Anton Bauer/DC IN) and low power consumption.
- Side-by-side rack mounting (with optional BT-MA900G).

BT-LH80WU

SDI (HD/SD) standard equipment. The 7.9" wide-screen LCD is sized perfectly for recording use or installation in a vehicle. A focus assist function lets this monitor serve as a viewfinder for an HD camera.

- Advanced image-enhancing circuitry, including an I/P conversion circuit for excellent motion response and a diagonal line compensation circuit.
- Marker and blue-only functions.
- Waveform monitoring.
- Cross hatch overlay display.
- Pixel-to-pixel display without resizing HD pixels.
- Focus-in-Red function for easy HD focusing by showing sharply focused edges in red.
- Thin, small and light for on-camera mounting.
- Production-tough aluminum diecast frame.
- SDI (HD/SD) and component input.
- 15-pin viewfinder terminal for compatible camera-recorders.*2
- RS-232C/GPI remote control terminals.
- Tally lamp (red, green)
- DC operation (Anton Bauer/DC IN) and low power consumption.
- Side-by-side rack mounting (with optional adaptor).

*1: The model number written on the front panel of the product is BT-LH80W.
*2: AJ-HPX3000G/HPX2100/HPX2000/HDC27H/HDX900/AG-HPX500 and AG-HPX502 (AG-HPX500/502 displays SD resolution in black-and-white.)



Five Advanced Technologies in the New BT-LH2550



1 A Wide Color Space with Six Color Space Modes

The color space of the BT-LH2550 is 102% that of the NTSC standard, so it exceeds the EBU/SMPTE range that can be displayed by ordinary LCDs. It accurately reproduces colors that are not easily reproduced by conventional displays, including CRTs, to meet the needs of both broadcasters and image production companies, and to work in fields such as digital cinema, CG production, printing, publishing, advertising, and research. The BT-LH2550 also offers three new color space modes in addition to the three conventional modes. The modes are menu switched. Modes can also be assigned to function switches on the front panel for quick and easy changing.

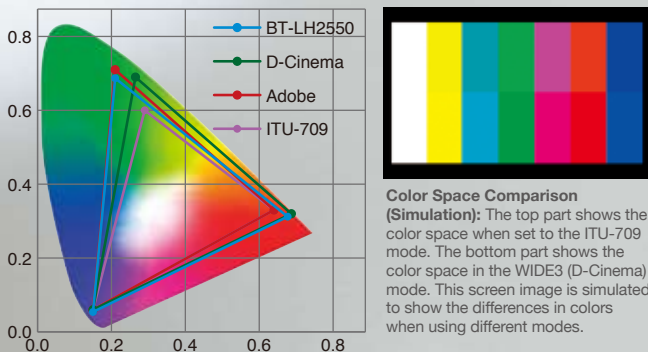

BT-LH2550 Color Space Modes

- | | |
|-------------|------------------------------------|
| 1. SMPTE-C: | SMPTE-C standard |
| 2. EBU: | EBU standard |
| 3. ITU-709: | ITU-R BT.709 standard |
| 4. WIDE1: | Adobe color space, gamma of 2.2 |
| 5. WIDE2: | Adobe color space, gamma of 1.8 |
| 6. WIDE3: | D-Cinema color space, gamma of 2.6 |

2 A Space-Saving 25.5-inch Full-HD Monitor

The BT-LH2550 is a full-HD WUXGA (1920 x 1200-pixel) high-resolution IPS monitor. It is 10% narrower, 7% shorter, and has a 16% smaller footprint than our previous BT-LH2600W model with the same screen size.



3 An IPS Panel with a Wide 178° Viewing Angle

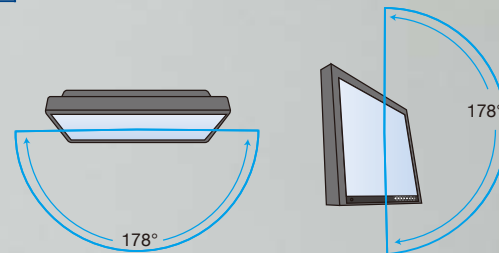

This high-brightness, high-contrast, horizontally aligned (using IPS technology) LCD panel has 178° vertical and horizontal viewing angles, the widest viewing angles offered by any LCD display. It delivers high-quality images with superb color accuracy, and exhibits minimal changes in brightness and color due to the viewing angle.

4 Calibration Function

The BT-LH2550 comes installed with calibration software that allows it to be calibrated without using a PC, by simply connecting a manufacturer-designated display color analyzer and measurement probe to the monitor.



*Konica Minolta CA-210 Display Color Analyzer with CA-PU12/CA-PU15 Standard Measurement Probe. For more information for Konica Minolta calibration system, please refer to <<http://www.konicaminolta.com/instruments/index.html>>.

5 2-Input Split-Screen Function

This function simultaneously displays two images side-by-side from two video inputs. It is especially useful for combining CGs and actual images. Because a single monitor can temporarily serve as two monitors, it helps to save space. It is also possible to set the size, color space, and gamma and RGB gains individually for each input.

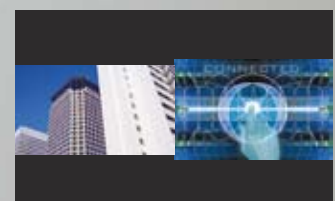

*It may not be possible to display both images simultaneously with certain input signal combinations.

High-Quality Picture Ideal for Production Applications

Faithful Color Reproduction Meets Broadcasting Needs

[2550] [1760] [1710]

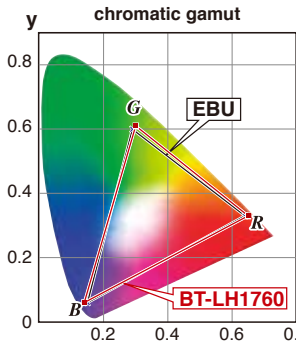

The BT-LH2550/BT-LH1760/BT-LH1710 features a new image processing engine. By using a three-dimensional LUT (Look Up Table) for each RGB color and applying precise 10-bit image processing, it achieves faithful color reproduction from low to high brightness levels in all video formats.

* SMPTE-C in North America.

I/P Conversion Circuit for Motion Response

[2550] [1760] [1710] [80WU]

A circuit delay time (not including panel delay) of approximately 5 msec*1 is achieved by incorporating an I/P converter circuit that converts SD and HD interlace signals with high precision and generates a progressive signal without causing field-length delay. Minimizing the delay between the input signal and monitor output enables the user to confirm footage without any incongruity.

*1: Differs slightly depending on the signal format.

Diagonal Line Compensation

[2550] [1760] [1710] [80WU]



Conventional Vertical Interpolation

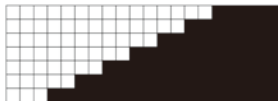

New Diagonal Interpolation

Jagged noise on diagonal lines in moving images is a common problem. These LCD monitors solve this by detecting correlations in the diagonal direction, resulting in smooth, precise reproduction of moving images.

Gamma Compensation for Each Monitor

[2550] [1760] [1710]

In order to make the LCD monitor suitable for professional broadcasting applications, compensation is conducted for each monitor in 256 discrete RGB steps, rated gamma properties ($g = 2.2$) are reproduced, and gradation suitable for broadcasting is achieved. Color temperature of 9300K/6500K/5600K; 3000K to 9300K can be selected with the variable setting.

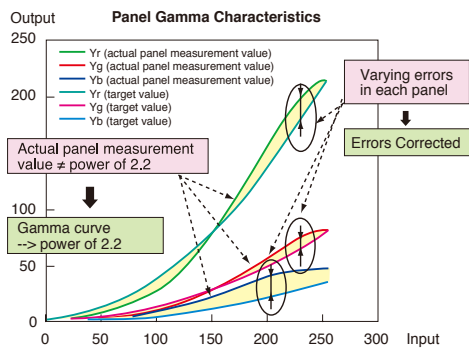

Double-Speed Drive for Blur-Less Moving Images

[1760]

Moving images without any afterimage are achieved by driving at a speed (120 Hz/100 Hz) that is twice the panel speed and inserting a black frame of a certain level between frames. Unlike frame creation methods, this system minimizes afterimages while displaying images faithful to the input signal. This high-performance, high-speed image display function is ideal for broadcast applications.

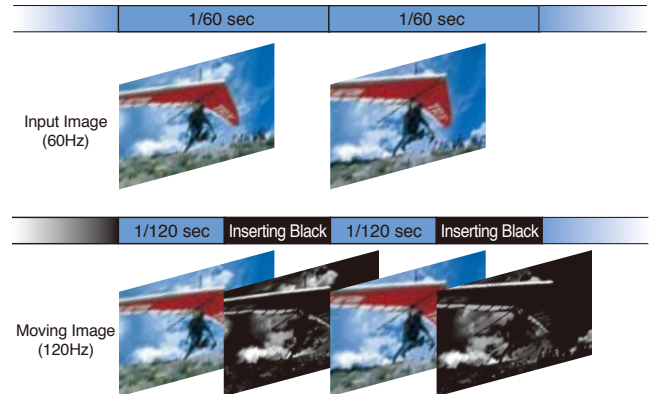

High-Speed Response

[2550] [1760] [1710]

The biggest concern when receiving a video feed is response time in the intermediate gradations. The BT-LH1760 uses double-speed drive to achieve superb response over the entire image, enabling the vivid image display without blurring. The BT-LH2550 and BT-LH1710 feature an overdrive circuit to improve response in intermediate gradations.

Wide Viewing Angle

[2550] [1760] [1710] [900A]

By using a high-intensity, high-contrast LCD panel, wide viewing angle is achieved in all models. The BT-LH2550 has a 178°, and the BT-LH1760/LH1710 has a 176° horizontal and vertical viewing angle. The BT-LH900A also has a 170° horizontal and vertical viewing angle. Easy viewing is ensured by reducing changes in color due to the viewing angle.

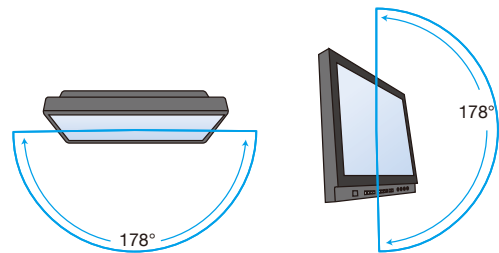

HD/SD Multi-Format

[2550] [1760] [1710] [900A] [80WU]

Compatible with most HD and SD formats, Panasonic LCD monitors are ideal for a wide range of applications in locations around the world.

Useful Display Functions for Professional Use

Various Markers

[2550] [1760] [1710] [900A] [80WU]



4:3 Aspect Marker



Safe Area and Center Marker



4:3 Aspect and Safe Area Marker
(BT-LH2550/LH1760/LH1710/LH80WU)

Various markers can be displayed in both 16:9 and 4:3 aspect ratios.

- **Aspect Marker (16:9):** 4:3, 13:9, 14:9, CNSCO or VISTA, with background brightness control of Black (0%), Half (50%) or Normal (100%).

- **Safe Area Marker (16:9/4:3):** 95%, 93%, 90%, 88% or 80%. In 16:9 mode, the BT-LH2550/LH1760/LH1710/LH80WU can display a superimposed safe area marker corresponding to the aspect marker's angle of view.

- **Center Marker (16:9/4:3):** ON/OFF. The center marker can be displayed together with another marker, as shown in the example on the left.

Cross Hatch Overlay

[2550] [1760] [1710] [80WU]



A simple cross hatch overlay can be displayed (at 120* dots interval, fixed) to check the tilt of the camera. You can also allocate the cross hatch function to any of the three function keys.

*80 dots for the BT-LH1760/LH1710,
50 dots for the BT-LH80WU.

Waveform Monitoring

[2550] [1760] [1710] [900A] [80WU]



All lines of the input signal is displayed as a waveform for monitoring. The BT-LH2550/LH1760/LH1710 waveform display can be positioned in any of the four corners of the screen. The BT-LH900A/LH80WU waveform is displayed in the lower right portion of the screen.

Vectorscope Display

[2550] [1760] [1710]



All lines of the input signal is displayed as a vectorscope, and can be positioned in any of the four corners of the screen.

HV Delay Display and Mono Mode

[2550] [1760] [1710] [900A*1] [80WU*2]

The HV Delay function that displays the video blanking period, and the Mono mode that switches the display to black-and-white can be assigned to function keys for quick access.

*1: LH900A: not assignable on function keys (need to be set on menu).

*2: LH80WU: Mono Mode only.

Pixel-to-Pixel Display

[1760] [1710] [80WU]



This function lets you display and confirm video pixels input in HD-SDI without any resizing. In the BT-LH1760/LH1710, this function is useful for image confirmation. When using 1080i, choose from five display areas: center, right-top, right-bottom, left-top or left-bottom. In the BT-LH80WU, this function facilitates focusing. With 1080/60i input signals, you can check the focus with a screen width equivalent to 19 inches.

Coordination of Multiple Cameras on Split Screens

[2550] [1760] [1710]



A frame of video can easily be frozen and displayed as a still image on the left side of the screen. This function can be used to match a live camera with a frame of video shot at an earlier time or with a different camera. There are two display modes: FULL for displaying and comparing the entire image on the screen, and PART for displaying and comparing only the center part of the images. (FULL-only on LH2550)

Audio Level Meter Overlay

[2550] [1760] [1710]



The BT-LH2550/LH1760/LH1710 come with an audio embedded function. In addition, the SDI-input audio level can be displayed on the screen with a white skeleton bar meter. Choose from 2-channel/4-channel/8-channel/OFF for the display.

Time Code Display Function

[2550] [1760] [1710]



With HD-SDI input, this function displays the value of the VITC, LTC or UB time code, depending on which one has been selected.

Closed Caption Function

[2550] [1760] [1710]



When an NTSC video signal is input, this function can display close captions (32 characters x 15 lines). The display mode can be selected from CC1, CC2, CC3 or CC4.

Cine Gamma Compensation

[2550] [1760] [1710] [900A]

Equipped with a cine-gamma (F-REC) compensation function for compatibility as a monitor for the Varicam AJ-HDC27H Camcorder. This function supports the production of movies, film-like HDTV programs, and TV commercials.

Focus-in-Red Function for HD Shooting

[80WU]



This function emphasizes the sharply focused area of the image by showing it in an easily visible red, making it easier to focus the HD camera.

Design and Functionality for Diverse Applications

Compact, Ergonomic Design [2550] [1760] [1710] [900A] [80WU]

The interface section and operation section are integrated into the compact body. Taking advantage of the slim size and light weight of the LCD panel, this integrated design enhances setup flexibility and simplifies operation.

Detachable Control Panel Adds Versatility [900A]

The control panel is separated from the monitor, making the BT-LH900A suitable for a wide range of applications, including use as a monitor or viewfinder.

Function Keys [2550] [1760] [1710] [900A] [80WU]

Each of the function keys on the front panel can be assigned with a function selected from various display and switchover functions* to enable one-touch display ON/OFF or mode change. These function buttons speed operation and customize the functions to the individual user's needs.

Functions Assignable to Function Keys (for the BT-LH1760*)

HV Delay/Autosetup/Blue Only/Gamma Select/
SD Aspect/Scan/Sub Window/WFM/Vector/Marker/
Pixel to Pixel/Pixel Position/Level Meter/Cross Hatch/Mono/
Time Code/Closed Caption/Undef

* Assignable functions vary depending on the model.

Production Tough for Field Use [1760] [1710] [900A] [80WU]



Panasonic BT-Series LCD monitors are built with an aluminum diecast frame. This superior build quality has been proven in the field to be production tough.

* Front section only for the BT-LH1760/LH1710.

SDI and Component Input [2550] [1760] [1710] [900A] [80WU]

All five monitors allow for SDI with automatic switching between HD and SD. The BT-LH2550/LH1760/LH1710 are equipped with two SDI inputs and one SDI output. These models are also equipped with a component input (Y, Pb, Pr, RGB switching), Y/C, and composite. RGB is compatible with PC input.

The BT-LH900A is equipped with two SDI inputs and one SDI output, one component input (Y, Pb, Pr or RGB switching), and one composite input. The BT-LH80WU is equipped with SDI (HD/SD) and Component (Y, Pb, Pr) input.

DVI-D Terminal (HDCP supported) [2550] [1760] [1710]

The BT-LH1760 is equipped with a DVI-D input terminal for connection to a digital device with DVI-D output. It also supports HDCP, so a device with an HDMI terminal, such as a BD/DVD player, can be connected using a commercially available conversion cable or adapter.

* DVI-A (analog) and DVI-DL (Dual Link) are not supported.

External Remote Compatibility [2550] [1760] [1710] [900A] [80WU]

The standard RS-232C (9-pin) and GPI (9-pin) remote input terminals allow the monitor to be operated by an external device.

Tally Lamps [2550] [1760] [1710] [900A] [80WU]

The front panel has red and green tally lamps. The BT-LH80WU also has a rear tally lamp for added convenience when using as a viewfinder.

Viewfinder Connector [80WU]

Equipped with a 15-pin viewfinder terminal, the BT-LH80WU can also be used as a viewfinder* for compatible Panasonic camera-recorders — AJ-HPX3700, AJ-HPX2700, AJ-HPX3000, AJ-HDX900, AJ-HDC27H, AJ-HPX2000 (US model), AJ-HPX2100 (European/Asian model), AG-HPX500* and AG-HPX502* (Asian model).

You can also run the BT-LH80WU on DC power supplied by these camera-recorders. Connection is easy, requiring only a viewfinder cable and DC power cable, supplied as the optional BT-CS80G.

*Optional hardware is required for mounting to a camera-recorder.

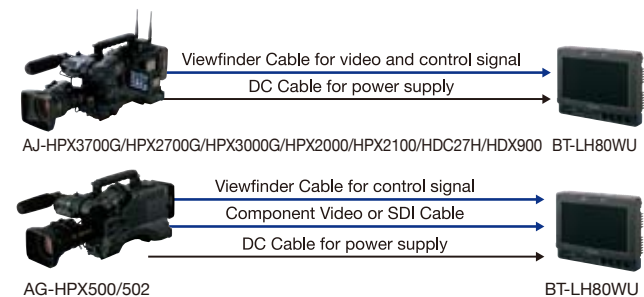

Stereo Speakers [1760] [1710]

The built-in speakers on the right and left sides of the screen let you confirm stereo sound without having to connect external speakers.

Headphone Jack [2550] [1760] [1710]

The BT-LH2550/LH1760/LH1710 are provided with a headphone jack.

Low Consumption Current [1760] [1710]

The low-current-consuming LCD provides extra flexibility for use in an OB van or in the studio, and provides high cost-effectiveness. The consumption current of the BT-LH1760 operating on AC power is about 50% lower than our previous model.

Fanless Drive [2550] [1760] [1710]

Fanless drive and its quiet operation make these models ideal for use in editing studios or MA rooms.

Power Save Mode [2550] [1760] [1710]

When no signal is received for 60 continuous seconds, the Power Save Mode is activated to minimize power consumption.

DC and Low Power Operation [900A] [80WU]

DC operation (Anton Bauer/DC IN) makes the BT-LH900A and BT-LH80WU ideal for use outdoors. Power consumption is very low, despite their HD/SD compatibility.

Rack Mounting [1760] [1710] [900A] [80WU]

These four models can be mounted in a 19" rack. The BT-LH80WU and BT-LH900A allow side-by-side rack mounting when optional rack mounting hardware is used. The BT-LH1760 and BT-LH1710 use the optional BT-MA1710G adaptor for rack mounting.

Wall Mounting [2550] [1760] [1710]

The optional wall mounting hardware (BT-WMA17G or BT-WMA26G, sold separately) allows wall mounting of these thin, lightweight LCD monitors.

Protective Panel [1760] [1710]

The optional protective panel (BT-PRP17G) protects the LCD panel from environmental elements such as sand and dust in outdoor use.

Front and Rear Panels and Interfaces

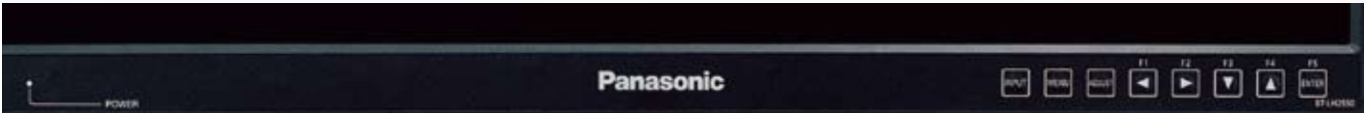

BT-LH2550



BT-LH1760



BT-LH1710



BT-LH900A



BT-LH80WU



BT-LH2550 Rear Panel



BT-LH900A Rear Panel



BT-LH1760 Rear Panel



BT-LH80WU Rear Panel



BT-LH1710 Rear Panel

Supported Video Format

Input Signal	BT-LH2550/LH1760/LH1710					
	VIDEO	SDI 1	SDI 2	YPbPr (*1)	RGB-VIDEO (*1)	DVI-VIDEO (*2)
NTSC	✓					
PAL	✓					
480/59.94i		✓	✓	✓	✓	
480/59.94p				✓	✓	✓
576/50i		✓	✓	✓	✓	
576/50p				✓	✓	✓
720/50p		✓	✓	✓		✓
720/59.94p		✓	✓	✓	✓	✓
720/60p		✓	✓	✓	✓	✓
1035/59.94i		✓ (*3)	✓ (*3)	✓ (*3)	✓ (*3)	
1035/60i		✓ (*4)	✓ (*4)	✓ (*4)	✓ (*4)	
1080/23.98PsF		✓	✓	✓		
1080/24PsF		✓	✓	✓		
1080/23.98p		✓	✓	✓		
1080/24p		✓	✓	✓		
1080/25p		✓	✓	✓		
1080/29.97p		✓	✓	✓		
1080/30p		✓	✓	✓		
1080/50i		✓	✓	✓	✓	✓
1080/50p				✓		✓
1080/59.94i		✓	✓	✓	✓	✓
1080/60i		✓	✓	✓	✓	✓
1080/59.94p				✓		✓
1080/60p				✓		✓

✓: Supported *1: One pair of terminals is provided for YPbPr and RGB input. The input signal type is selected in the menu. For RGB, the input signal type is selected from VIDEO or COMP.
 *2: When a DVI-D input terminal is used, the input signal type is selected from VIDEO or COMP. *3: When a 1035/59.94i signal is input, images are displayed in 1080/59.94i. In that case, the displayed markers are for 1080/59.94i. *4: When 1035/60i signal is input, images are displayed in 1080/60i. In that case, the displayed markers are for 1080/59.94i.

Input Signal	BT-LH2550		BT-LH1760/LH1710	
	RGB-COMP. (*1)	DVI-COMP. (*2)	RGB-COMP. (*1)	DVI-COMP. (*2)
640 x 400 (70Hz)	✓		✓	
640 x 480 (60Hz)	✓	✓	✓	✓
640 x 480 (75Hz)	✓		✓	
640 x 480 (85Hz)	✓		✓	
800 x 600 (60Hz)	✓	✓	✓	✓
800 x 600 (70Hz)	✓		✓	
800 x 600 (75Hz)	✓		✓	
800 x 600 (85Hz)	✓		✓	
1024 x 768 (60Hz)	✓	✓	✓	✓
1024 x 768 (70Hz)	✓		✓	
1024 x 768 (75Hz)	✓		✓	
1024 x 768 (85Hz)	✓		✓	
1280 x 768 (50Hz)	✓	✓	✓	✓
1280 x 768 (60Hz)	✓	✓	✓	✓
1280 x 768 (75Hz)	✓		✓	
1280 x 1024 (60Hz)	✓	✓	✓	✓
1600 x 1200 (60Hz)	✓	✓		
1920 x 1200 (60Hz)	✓	✓		

✓: Supported *1: One pair of terminals is provided for YPbPr and RGB input. The input signal type is selected in the menu. For RGB, the input signal type is selected from VIDEO or COMP. *2: When a DVI-D input terminal is used, the input signal type is selected from VIDEO or COMP.

Input Signal	BT-LH900A				BT-LH80WU				
	VIDEO	SDI	YPbPr (*1)	RGB (*1)	VIDEO	VF-VIDEO (*2)	VF-YPbPr (*2)	YPbPr	SDI
NTSC	✓				✓	✓			
PAL	✓				✓	✓			
480/59.94i		✓	✓	✓			✓	✓	✓
480/59.94p			✓	✓			✓	✓	
576/50i		✓	✓	✓			✓	✓	✓
576/50p							✓	✓	
720/50p		✓	✓				✓	✓	✓
720/59.94p		✓	✓	✓			✓	✓	✓
720/60p		✓	✓	✓			✓	✓	✓
1035/59.94i		✓ (*3)	✓ (*3)	✓ (*3)			✓ (*3)	✓ (*3)	✓ (*3)
1035/60i		✓ (*4)	✓ (*4)	✓ (*4)			✓ (*4)	✓ (*4)	✓ (*4)
1080/23.98PsF		✓	✓				✓	✓	✓
1080/24PsF		✓	✓				✓	✓	✓
1080/23.98p		✓	✓						
1080/24p		✓	✓						
1080/25p		✓	✓						
1080/29.97p		✓	✓						
1080/30p		✓	✓						
1080/50i		✓	✓	✓			✓	✓	✓
1080/59.94i		✓	✓	✓			✓	✓	✓
1080/60i		✓	✓	✓			✓	✓	✓

✓: Supported *1: One pair of terminals is provided for YPbPr and RGB input. The input signal type is selected in the menu. For VF, the input signal type is selected from VIDEO or YPbPr. *2: When a 1035/59.94i signal is input, images are displayed in 1080/59.94i. In that case, the displayed markers are for 1080/59.94i. *3: When 1035/60i signal is input, images are displayed in 1080/60i. In that case, the displayed markers are for 1080/59.94i.

Dimensions

BT-LH2550

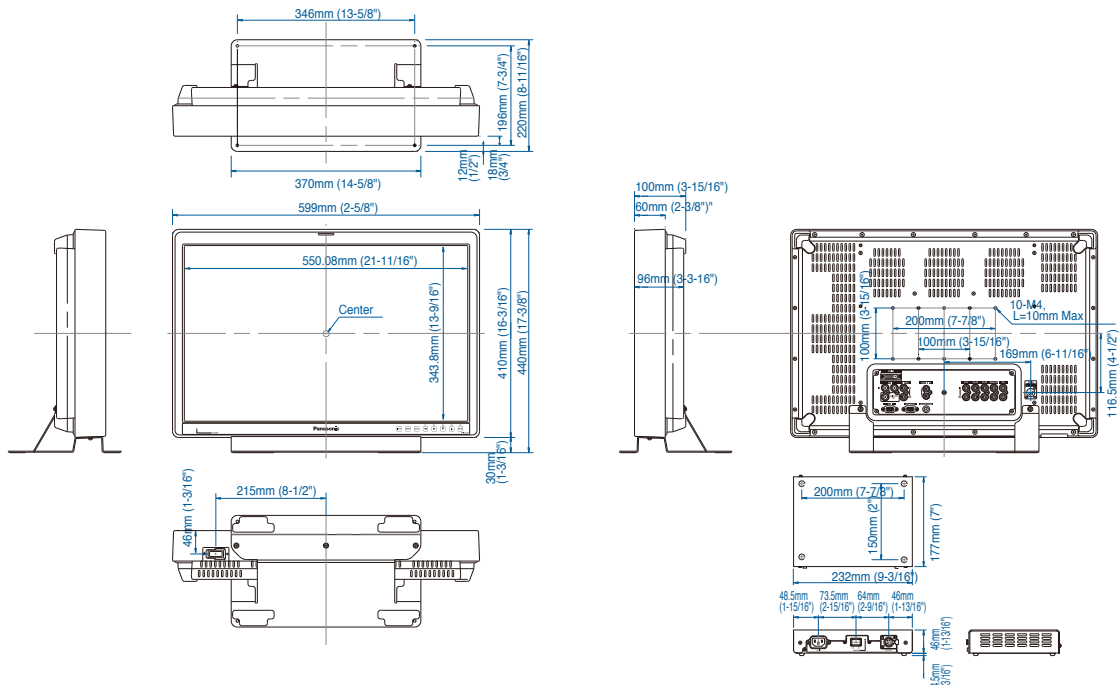

BT-LH1760/LH1710

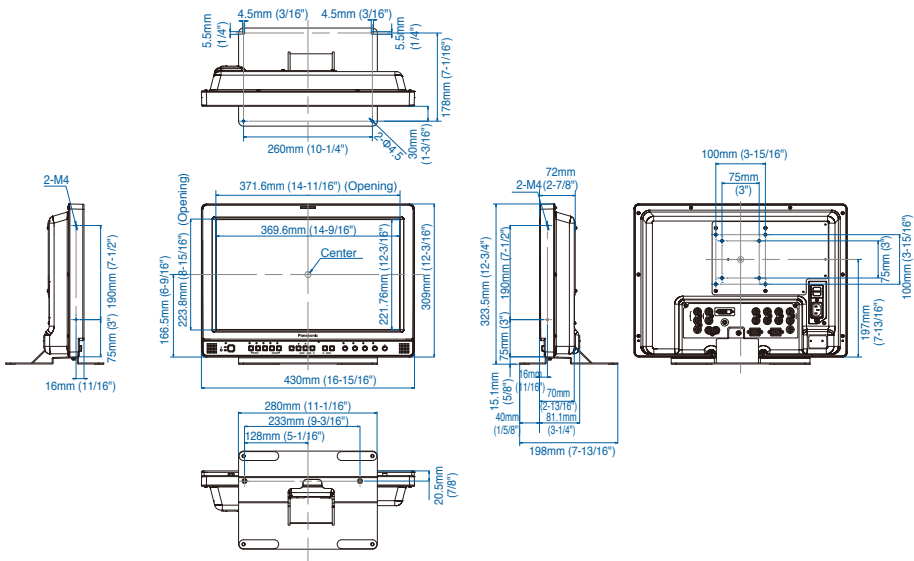

BT-LH900A

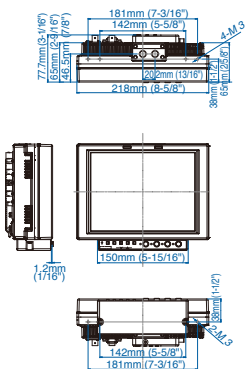

BT-LH80WU

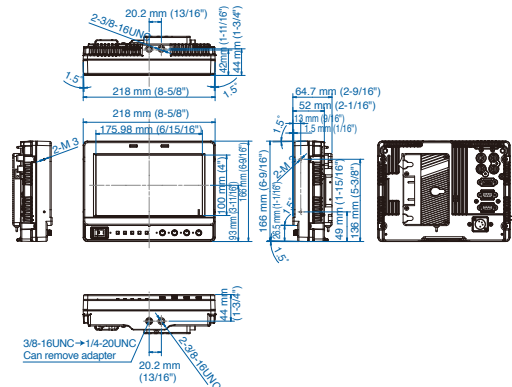

Specifications

	BT-LH2550	BT-LH1760	BT-LH1710
GENERAL			
Power Requirement:	DC 24 V 4.5 A, DC 5 V 0.03 A AC adapter In: 100 V to 240 V, 50/60 Hz, 1.6 A to 0.6 A	AC 100 V to 240 V 50/60 Hz, 0.6 A to 0.3 A DC 12 V (11 V to 17 V) 4.0 A	AC 100 V to 240 V 50/60 Hz, 0.6 A to 0.3 A DC 12 V (11 V to 17 V) 4.0 A
Dimensions (WxHxD):	599 mm x 440 mm x 220 mm (23-5/8" x 17-3/8" x 8-11/16", Including stand) 599 mm x 410 mm x 100 mm (23-5/8" x 16-3/16" x 3-15/16", Main unit only; not including stand) AC adapter: 232 mm x 50.5 mm x 177 mm (9-3/16" x 2" x 7")	430 mm x 323.5 mm x 198mm (16-15/16" x 12-3/4" x 7-13/16", Including stand) 430 mm x 309 mm x 81.1mm (16-15/16" x 12-3/16" x 3-1/4", Main unit only; not including stand)	430 mm x 323.5 mm x 198mm (16-15/16" x 12-3/4" x 7-13/16", Including stand) 430 mm x 309 mm x 81.1mm (16-15/16" x 12-3/16" x 3-1/4", Main unit only; not including stand)
Weight:	9.7 kg (21.4 lbs) (Including stand), 8.2 kg (18.1 lbs) (not including stand) AC adapter: 1.7 kg (3.7 lbs)	7.1 kg (15.7 lbs) (Including stand), 6.2 kg (13.7 lbs) (not including stand)	7.1 kg (15.7 lbs) (Including stand), 6.2 kg (13.7 lbs) (not including stand)
Operating Temperature:	+5°C to +35°C (41°F to 95°F)	+5°C to +35°C (41°F to 95°F)	+5°C to +35°C (41°F to 95°F)
Operating Humidity:	20 % to 80 % (non dew)	20 % to 80 % (non dew)	20 % to 80 % (non dew)
Storage Temperature:	-20°C to +60°C (-4°F to 140°F)	-20°C to +60°C (-4°F to 140°F)	-20°C to +60°C (-4°F to 140°F)
LCD PANEL			
Panel Size:	26 inch	17.0 inch	17.0 inch
Aspect Ratio:	16:9	15:9	15:9
Double Speed Drive: (100Hz/120Hz)	—	Yes	—
Resolution:	1,920 x 1,200 pixels (WXGA)	1,280 x 768 pixels (WXGA)	1,280 x 768 pixels (WXGA)
Display colors:	Approx. 16,770,000 colors	Approx. 16,770,000 colors	Approx. 16,770,000 colors
Viewing Angle:	178° (both horizontal and vertical)	178° (both horizontal and vertical)	178° (both horizontal and vertical)
CONNECTORS			
Video input/output:	Video: BNC x 2, (with through-out connector) Y/Pb/Pr. RGB: BNC x 6 (with through-out connector x 3) SYNC/HD: BNC x 2(with through-out connector x 1) VD: BNC x 2(with through-out connector x 1) SDI: BNC x 3 (switched-out connector x 1) DVI-D (HDCP, TMDS Single Link): DVI-D x 1 Vertical frequency: 50.0 Hz to 60.0 Hz Horizontal frequency: 31.5 KHz to 67.5 KHz Dot clock: 25 MHz to 165 MHz	Video: BNC x 2, (with through-out connector) Y/Pb/Pr. RGB: BNC x 6 (with through-out connector x 3) SYNC/HD: BNC x 2(with through-out connector x 1) VD: BNC x 1 SDI: BNC x 3 (switched-out connector x 1) DVI-D (HDCP): DVI-D x 1 Vertical frequency: 50.0 Hz to 60.0 Hz Horizontal frequency: 31.5 KHz to 67.5 KHz Dot clock: 25 MHz to 165 MHz	Video: BNC x 2, (with through-out connector) Y/Pb/Pr. RGB: BNC x 6 (with through-out connector x 3) SYNC/HD: BNC x 2(with through-out connector x 1) VD: BNC x 1 SDI: BNC x 3 (switched-out connector x 1) DVI-D (HDCP): DVI-D x 1 Vertical frequency: 50.0 Hz to 60.0 Hz Horizontal frequency: 31.5 KHz to 67.5 KHz Dot clock: 25 MHz to 165 MHz
Audio input:	Pinjack x 2 (stereo)	Pinjack x 2 (stereo)	Pinjack x 2 (stereo)
Headphone output:	M3 stereo mini jack x 1	M3 stereo mini jack x 1	M3 stereo mini jack x 1
Remote:	GPI: D-SUB, 9 pin RS-232C: D-SUB, 9pin	GPI: D-SUB, 9 pin RS-232C: D-SUB, 9 pin	GPI: D-SUB, 9 pin RS-232C: D-SUB, 9 pin
External DC power input:	XLR, 4pin (Supplied AC adapter only)	XLR, 4pin	XLR, 4pin
SIGNAL LEVEL			
Video:	SYNC signal level: 0.3 Vp-p to 4.0 Vp-p HD/VD Signal level: TTL level	SYNC signal level: 0.3 Vp-p to 4.0 Vp-p HD/VD Signal level: TTL level	SYNC signal level: 0.3 Vp-p to 4.0 Vp-p HD/VD Signal level: TTL level
Audio:	Audio input signal level: 0.5 Vrms Head phone output: 32 Ω, Variable Level	Audio input signal level: 0.5 Vrms Speaker output: 0.5 W + 0.5 W Head phone output: 32 Ω, Variable Level	Audio input signal level: 0.5 Vrms Speaker output: 0.5 W + 0.5 W Head phone output: 32 Ω, Variable Level
SDI Embedded Audio:	HD-SDI : SMPTE299M standard, 48 kHz, 8CH synchronous/asynchronous SD-SDI : SMPTE272M standard, 48 kHz, 4CH synchronous	HD-SDI : SMPTE299M standard, 48 kHz, 8CH synchronous/asynchronous SD-SDI : SMPTE272M standard, 48 kHz, 4CH synchronous	HD-SDI : SMPTE299M standard, 48 kHz, 8CH synchronous/asynchronous SD-SDI : SMPTE272M standard, 48 kHz, 4CH synchronous
OTHERS			
Supplied Accessories:	AC adapter, Power cord, Power cord hook, Screw, DC cable	Power cord, power cord hook, screw	Power cord, power cord hook, screw
Option:	Wall Mount Adaptor	Rack mount adaptor, Wall Mount Adaptor, Protective Panel	Rack mount adaptor, Wall Mount Adaptor, Protective Panel

	BT-LH900A	BT-LH80WU
GENERAL		
Power Requirement:	DC 12 V (11 V to 17 V), 1.45 A	DC 12 V (11 V to 17 V), 1.5 A
Dimensions (WxHxD):	218 mm x 176 (4U) mm x 65 mm (8-5/8" x 6-15/16" x 2-9/16")	218 mm x 166 mm x 64.7 mm (8-5/8" x 6-9/16" x 2-9/16")
Weight:	2.0 kg (4.4 lbs)	1.5 kg (3.3 lbs)
Operating Temperature:	+0°C to +40°C (32°F to 104°F)	+0°C to +40°C (32°F to 104°F)
Operating Humidity:	10 % to 85 % (non dew)	10 % to 85 % (non dew)
Storage Temperature:	-20°C to +60°C (-4°F to 140°F)	-20°C to +60°C (-4°F to 140s°F)
LCD PANEL		
Panel Size:	8.4 inch	7.9 inch (Effective display)
Aspect Ratio:	4:3	16:9 (Effective display area)
Resolution:	1,024 x 768 pixels (XGA)	800 x 450 pixels (Effective display area)
Display colors:	Approx. 16,770,000 colors	Approx. 16,770,000 colors
Viewing Angle:	170° (both horizontal and vertical)	110° vertical, 120° horizontal
CONNECTORS		
Video input:	Video: BNC x 2 (with through-out connector) Y/Pb/Pr. RGB: BNC x 3 SYNC: BNC x 1 SDI (BNC) x 3 (switched out connector x 1)	Video: BNC x 1 Y/Pb/Pr. RGB: BNC x 3 (Y shares with Video) SDI: BNC x 1 VF: D-SUB, 15pin x 1
Remote:	GPI: D-SUB, 9 pin RS-232C: D-SUB, 9 pin	GPI: D-SUB, 9 pin RS-232C: D-SUB, 9 pin
External DC power input:	XLR, 4 pin	XLR, 4 pin
OTHERS		
Supplied Accessories:	Battery holder for Anton/Bauer battery (Built-in)	Battery holder for Anton/Bauer battery (Built-in)
Option:	Rack mount adaptor	VF cable set (Viewfinder Cable, DC Cable)

The specifications shown above are subject to change without notice

Optional Accesories



BT-WMA26G (Indoor use only)
Wall Mount Adaptor
for BT-LH2550



BT-WMA17G (Indoor use only)
Wall Mount Adaptor
for BT-LH1760/LH1710



BT-PRP17G
Protective Panel
for BT-LH1760/LH1710



BT-MA1710G
Rack Mount Adaptor
for BT-LH1760/BT-LH1710



BT-MA900G
Rack Mount Adaptor
for BT-LH900A



BT-YA80G
SDI Input Unit
(For BT-LH80W only.
The BT-LH80WU is already
equipped with the BT-YA80G.)



BT-CS80G
VF Cable set for BT-LH80W/
LH80WU
(Viewfinder Cable, DC Cable)

Panasonic®

Panasonic Corporation
Systems Business Group
2-15 Matsuba-cho, Kadoma, Osaka 571-8503
Japan
Phone +81 6 6901 1161 Fax +81 6 6908 5969
<https://www.pavc.panasonic.co.jp/pro-av/>

[Countries and Regions]

Argentina	+54 1 308 1610	Kuwait	+96 522431385
Australia	+61 2 9986 7400	Lebanon	+96 11665557
Bahrain	+973 252292	Malaysia (PM & PSE)	+60 3 7809 7888
Belgium	+32 (0) 2 481 04 57	Mexico	+52 55 5488 1000
Bulgaria	+359 2 946 0786	Montenegro, Serbia	+41 (0) 26 466 25 20
Brazil	+55 11 3889 4035	Netherlands	+31 73 64 02 577
Canada	+1 905 624 5010	New Zealand	+64 9 272 0100
China	+86 10 6515 8828	Norway	+47 67 91 78 00
(Hong Kong)	+852 2313 0888	Pakistan	+92 5370320 (SNT)
Czech Republic	+420 236 032 552/511	Palestine	+972 2 2988750
Denmark	+45 43 20 08 57	Panama	+507 229 2955
Egypt	+20 2 23938151	Peru	+51 1 614 0000
Finland, Latvia, Lithuania, Estonia	+358 (9) 521 52 53	Philippines	+63 2 633 6162
France	+33 (0) 1 55 93 66 67	Poland	+48 (22) 338 1100
Germany, Austria	+49 (0) 611 235 401	Portugal	+351 21 425 77 04
Greece	+30 210 96 92 300	Puerto Rico	+1 787 750 4300
Hungary	+36 (1) 382 60 60	Romania	+40 21 211 4855
India	+91 11 2437 9961 to 4	Russia & CIS	+7 095 980 4206
Indonesia	+62 21 385 9449	Saudi Arabia	+96 626444072
Iran (Vida)	+98 21 2271463	Singapore	+65 6270 0110
(Panasonic Office)	+98 2188791102	Slovak Republic	+421 (0) 2 52 92 14 23
Italy	+39 02 6788 367	Slovenia, Croatia, Bosnia, Macedonia	+44 (0) 20 76 63 36 57
Jordan	+962 6 5859801	South Africa	+27 11 3131622
Kazakhstan	+7 727 298 0891	Spain	+34 (93) 425 93 00
Korea	+82 2 2106 6641		

Sweden	+46 (8) 680 26 41
Switzerland	+41 (0) 41 259 96 32
Syria	+963 11 2318422/4
Taiwan	+886 2 2227 6214
Thailand	+66 2 731 8888
Turkey	+90 216 578 3700
U.A.E. (for All Middle East)	+971 4 8862142
Ukraine	+380 44 4903437
U.K	+44 (0)1344 70 69 20
U.S.A.	+1 201 348 5300
Vietnam	+848 38370280



JQA-0443



Factories of Systems Business Group have received ISO14001:2004-the Environmental Management System certification. (Except for 3rd party's peripherals.)