

# PowerLogic power-monitoring units

## PM3200

Technical data sheet



# Power Meter Series PM3200

## Functions and characteristics



Power Meter Series PM3200



Power Meter Series PM3255

This PowerLogic Power meter offers basic to advanced measurement capabilities. With compact size and DIN rail mounting, the PM3200 allows mains and feeders monitoring in small electrical cabinets. Combined with current transformers and voltage transformers, these meters can monitor 2-, 3- and 4-wire systems. The graphic display has intuitive navigation to easily access important parameters.

Four versions are available offering basic to advanced applications:

- PM3200
  - Electrical parameters I, In, U, V, PQS, E, PF, Hz
  - Power/current demand
  - Min/max.
- PM3210
  - Electrical parameters I, In, U, V, PQS, E, PF, Hz, THD
  - Power/current demand, peak demand
  - Min/max.
  - 5 timestamped alarms
  - kWh pulse output
- PM3250
  - Electrical parameters I, In, U, V, PQS, E, PF, Hz, THD
  - Power/current demand, peak demand
  - Min/max.
  - 5 timestamped alarms
  - LED to indicate communications
  - RS485 port for Modbus communication
- PM3255
  - Electrical parameters I, In, U, V, PQS, E, PF, Hz, THD
  - Power/current demand and peak demand
  - Min/max. and 15 timestamped alarms
  - LED to indicate communications
  - Up to 4 tariffs management
  - 2 digital inputs, 2 digital outputs
  - Memory for load profile (demand 10mn to 60mn)
  - RS485 port for Modbus communication

Innovative design makes the meters smart and simple:

- Easy to install for panel builders
- Easy to commission for contractors and installers
- Easy to operate for end users

### Applications

#### Cost management applications

- Bill checking
- Sub-billing, including WAGES view
- Cost allocation, including WAGES view

#### Network management applications

- Panel instrumentation
- Up to 15 onboard timestamped alarms to monitor events
- Easy integration with PLC system by input/output interface

#### Market segments

- Buildings
- Industry
- Data centres and networks

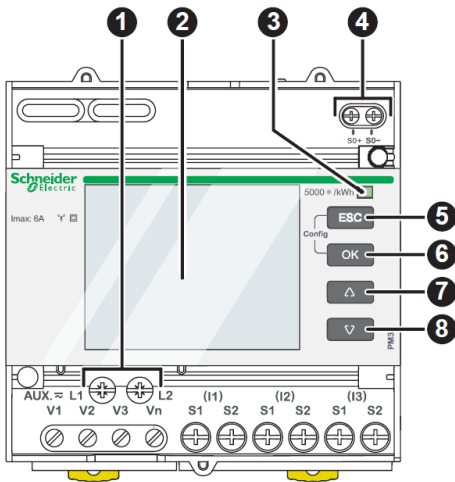

#### Front of meter parts

- 1 Control power
- 2 Display with white backlight
- 3 Flashing yellow meter indicator (to check accuracy)
- 4 Pulse output for remote transfer (PM3210)
- 5 ESC Cancellation
- 6 OK Confirmation
- 7  $\Delta$  Up
- 8  $\nabla$  Down

Meter model and description	Performance	Part no.
PM3200 basic power meter	Basic power meter	METSEPM3200
PM3210 power meter with pulse output	Power, current, THD, peak demand	METSEPM3210
PM3250 power meter with RS485 port	Power, current, THD, peak demand	METSEPM3250
PM3255 power meter plus 2 digital inputs, 2 digital outputs with RS485 port	Power, current, THD, peak demand, memory for load profile	METSEPM3255

Function guide	PM3200 Range			
	PM3200	PM3210	PM3250	PM3255
<b>Performance standard</b>				
IEC61557-12 PMD/Sx/K55/0.5	■	■	■	■
<b>General</b>				
Use on LV and HV systems	■	■	■	■
Number of samples per cycle	32	32	32	32
CT input 1A/5A	■	■	■	■
VT input	■	■	■	■
Multi-tariff	4	4	4	4
Multi-lingual backlit display	■	■	■	■
<b>Instantaneous rms values</b>				
Current, voltage Per phase and average	■	■	■	■
Active, reactive, apparent power Total and per phase	■	■	■	■
Power factor Total and per phase	■	■	■	■
<b>Energy values</b>				
Active, reactive and apparent energy; import and export	■	■	■	■
<b>Demand value</b>				
Current, power (active, reactive, apparent) demand; present	■	■	■	■
Current, power (active, reactive, apparent) demand; peak		■	■	■
<b>Power quality measurements</b>				
THD Current and voltage		■	■	■
<b>Data recording</b>				
Min/max of the instantaneous values	■	■	■	■
Power demand logs				■
Energy consumption log (day, week, month)				■
Alarms with time stamping		5	5	15
Digital inputs/digital outputs		0/1		2/2
<b>Communication</b>				
RS-485 port			■	■
Modbus protocol			■	■



Power Meter Series PM3210

Connectivity advantages	
Programmable digital input	External tariff control signal (4 tariffs) Remote Reset partial counter External status like breaker status Collect WAGES pulses
Programmable digital output	Alarm (PM3255) kWh pulses
Graphic LCD display	Backlit graphic display allows smart navigation in relevant information and in mult languages
Communication	Modbus RS485 with screw terminals allows connection to a daisy chain

# Power Meter Series PM3200

## Functions and characteristics (cont.)

Specifications	PM3200 Range
<b>Type of measurement</b>	True rms up to the 15th harmonic on three-phase (3P,3P+N) and single-phase AC systems. 32 samples per cycle
<b>Measurement accuracy</b>	
Current with x/5A CTs	0.3% from 0.5A to 6A
Current with x/1A CTs	0.5% from 0.1A to 1.2A
Voltage	0.3% from 50V to 330V (Ph-N), from 80V to 570V (Ph-Ph)
Power factor	±0.005 from 0.5A to 6A with x/5A CTs; from 0.1A to 1.2A with x/1A CTs
Active/Apparent Power with x/5A CTs	Class 0.5
Active/Apparent Power with x/1A CTs	Class 1
Reactive power	Class 2
Frequency	0.05% from 45 to 65Hz
Active energy with x/5A CTs	IEC62053-22 Class 0.5s
Active energy with x/1A CTs	IEC62053-21 Class 1
Reactive energy	IEC62053-23 Class 2
<b>Data update rate</b>	
Update rate	1s
<b>Input-voltage characteristics</b>	
Measured voltage	50V to 330V AC (direct / VT secondary Ph-N) 80V to 570V AC (direct / VT secondary Ph-Ph) up to 1MV AC (with external VT)
Frequency range	45Hz to 65Hz
<b>Input-current characteristics</b>	
CT primary	Adjustable from 1A to 32767A
CT secondary	1A or 5A
Measurement input range with x/5A CTs	0.05A to 6A
Measurement input range with x/1A CTs	0.02A to 1.2A
Permissible overload	10A continuous, 20A for 10s/hour
<b>Control Power</b>	
AC	100/173 to 277/480VAC (+/-20%), 3W/5VA; 45Hz to 65Hz
DC	100 to 300VDC, 3W
<b>Input</b>	
Digital inputs (PM3255)	11 to 40VDC, 24VDC nominal, <=4mA maximum burden, 3.5kVrms insulation
<b>Output</b>	
Digital output (PM3210)	Optocoupler, polarity sensitive, 5 to 30V, 15mA max, 3.5kVrms insulation
Digital outputs (PM3255)	Solid state relay, polarity insensitive, 5 to 40V, 50mA max, 50Ω max, 3.5kVrms insulation

Specifications (continued)	PM3200 Range
<b>Mechanical characteristics</b>	
Weight	0.26kg
IP degree of protection (IEC60529)	IP40 front panel, IP20 meter body
Dimension	90 x 95 x 70mm
<b>Environmental conditions</b>	
Operating temperature	-25 °C to +55 °C
Storage temperature	-40 °C to +85 °C
Humidity rating	5 to 95% RH at 50°C (non-condensing)
Pollution degree	2
Metering category	III, for distribution systems up to 277/480VAC
Dielectric withstand	As per IEC61010-1, Doubled insulated front panel display
Altitude	3000m max
<b>Electromagnetic compatibility</b>	
Electrostatic discharge	Level IV (IEC61000-4-2)
Immunity to radiated fields	Level III (IEC61000-4-3)
Immunity to fast transients	Level IV (IEC61000-4-4)
Immunity to surge	Level IV (IEC61000-4-5)
Conducted immunity	Level III (IEC61000-4-6)
Immunity to power frequency magnetic fields	0.5mT (IEC61000-4-8)
Conducted and radiated emissions	Class B (EN55022)
<b>Safety</b>	
	CE as per IEC61010-1 <sup>(1)</sup>
<b>Communication</b>	
RS485 port	Half duplex, from 9600 up to 38400 bauds, Modbus RTU (double insulation)
<b>Display characteristics</b>	
Dimensions (VA)	43mm x 34.6mm
Display resolution	128 x 96 dots
<b>Standard compliance</b>	
	IEC61557-12, EN61557-12 IEC61010-1, UL61010-1 IEC62052-11, IEC62053-21, IEC62053-22, IEC62053-23 EN50470-1, EN50470-3

(1) Protected throughout by double insulation

# Power Meter Series PM3200

## Installation and connection

### PM3200 series dimensions

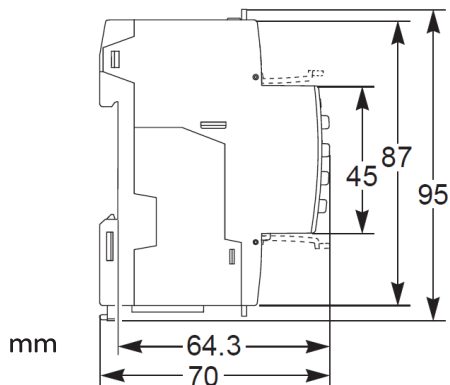
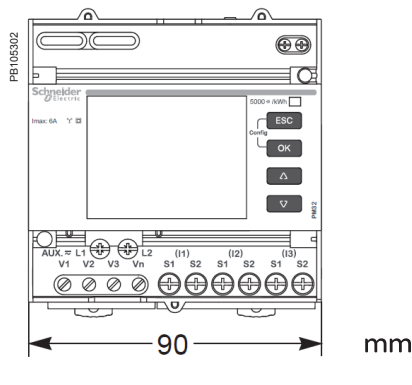
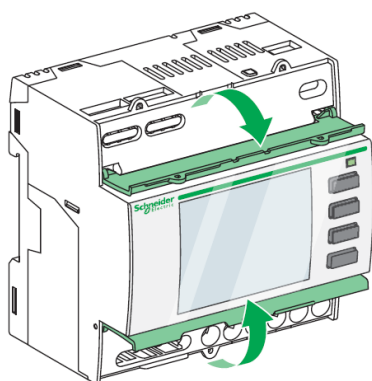

PM3200 top and lower flaps

### PM3200 series easy installation

PB105446

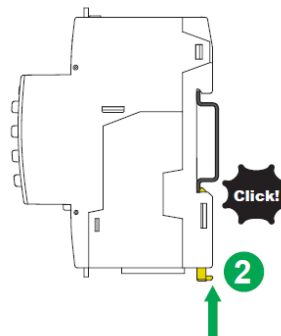
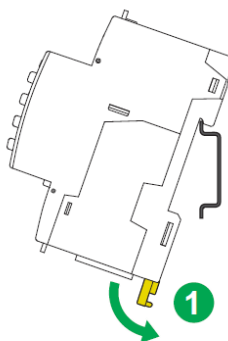

### Digital Output and Digital Input sample wiring diagrams

PB105445

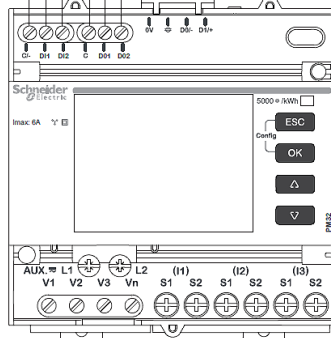
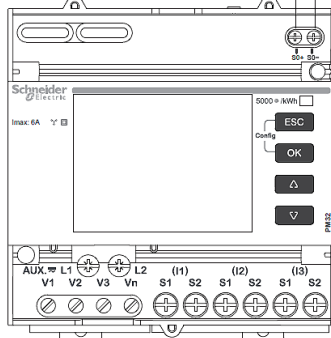
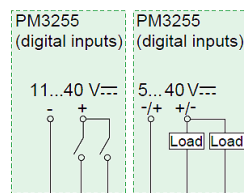
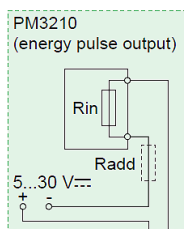

For PM3200/3210

For PM3250/3255

**Note:** These are sample wiring diagrams only. For further information please see the Instruction Sheet and User Guide documents for these products.

# Power Meter Series PM3200

## Installation and connection (cont.)

**Note:** These are sample wiring diagrams only. For further information please see the Instruction Sheet and User Guide documents for these products.

### Modbus communications wiring diagram

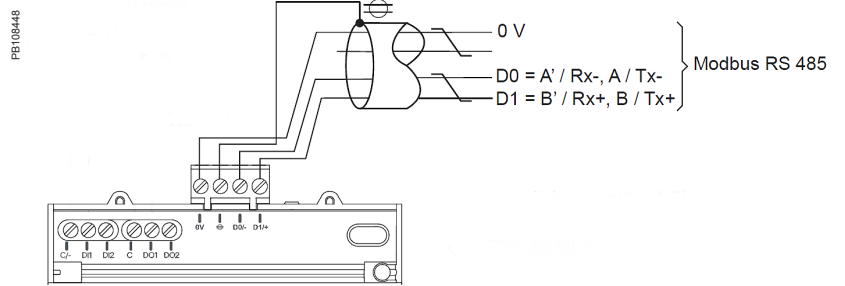

### PM32xx series sample wiring diagrams - 1 phase

- 1 Protection (to be adapted to suit the short-circuit current at the connection point)
- 2 Shorting switch unit

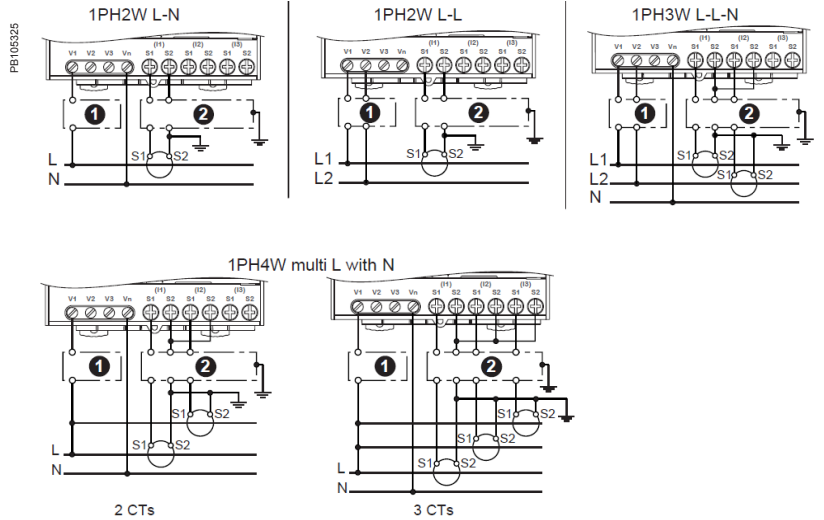

**Note:** These are sample wiring diagrams only. For further information please see the Instruction Sheet and User Guide documents for these products.

# Power Meter Series PM3200

## Installation and connection (cont.)

### PM32xx Series sample wiring diagrams - 3 phase without VTs

- 1 Protection (to be adapted to suit the short-circuit current at the connection point)
- 2 Shorting switch unit

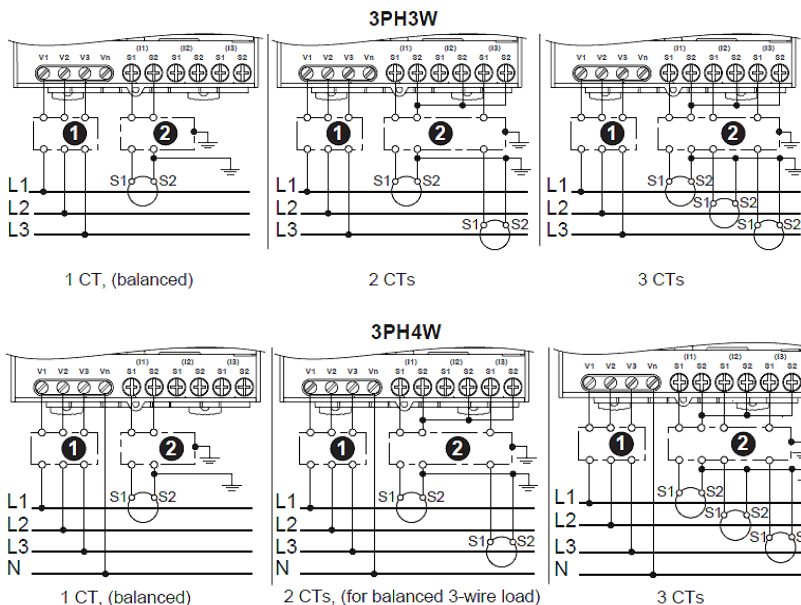

### PM32xx Series sample wiring diagrams - 3 phase with VTs

**Note:** These are sample diagrams only. For further information please see the Instruction Sheet and User Guide documents for these products.

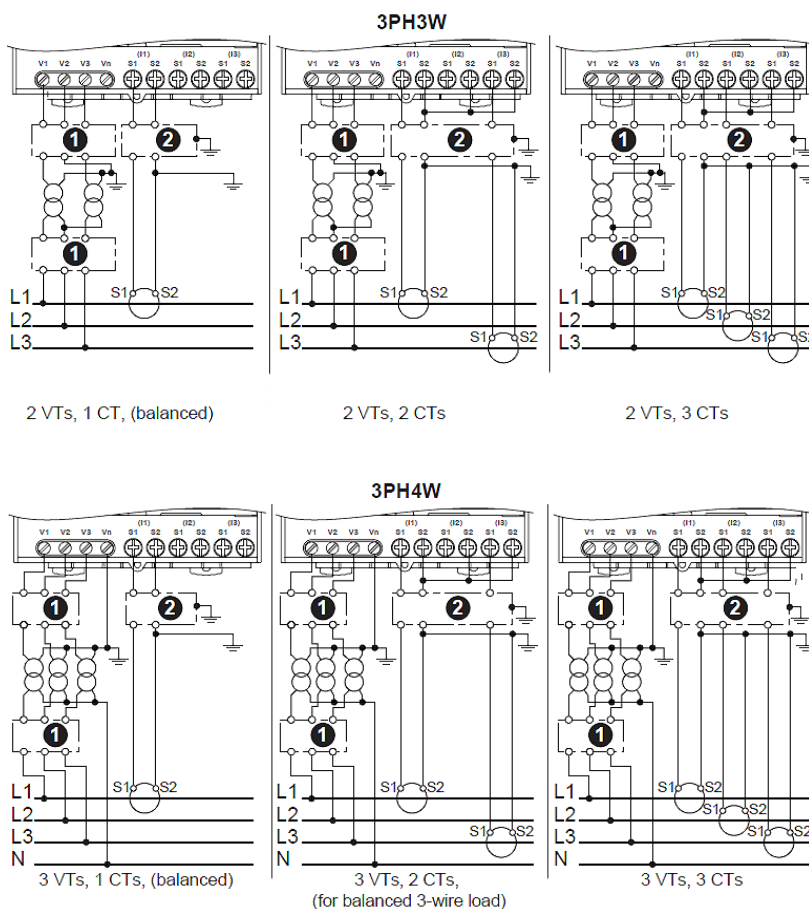



Schneider Electric Industries SAS  
35, Rue Joseph Monier,  
CS 30323  
F - 92506 Rueil Malmaison Cedex

RCS Nanterre 954 503 439  
Capital social 896 313 776  
[www.schneider-electric.com](http://www.schneider-electric.com)

PLSED310043EN

As standards, specifications and designs develop from time to time, please ask for confirmation of the information given in this document.



*This document has been printed on recycled paper*

Design: Schneider Electric  
Photos: Schneider Electric  
Printing: Altavia Connexion - Made in France



ART 960649 / © 2012 - Schneider Electric - All rights reserved

May 2012