



Muffin AC - MU3A1 - 028023
 (Family) (Model) (Part Number)

Electrical Specifications

Rated Voltage:	230 VAC
AC Frequency:	60 Hz
Power Supply:	14.0 Watts
Line Current:	0.09 Amps
Locked Rotor Current	0.13 Amps
Nominal Speed:	3100 RPM

Mechanical Specifications

Dimensions:	4.72in x 1.50in
Weight	17.2 oz
Max Airflow @ 0 in H ₂ O	102.0 CFM
Max Pressure @ 0 CFM	0.296 in H ₂ O
Noise	45.1 dBA



Comair Rotron, Inc.
 Phone: 858.348.6200
sales@comairrotron.com

Comair Rotron Europe, Ltd.
 Phone: +44.1527.520525
saleseurope@comairrotron.com

Comair Rotron Fan Company Ltd.
 Phone: +86.21.52260581
salesasia@comairrotron.com

Print Date: Monday, February 18, 2008 at 00:51:30 - AC Fan Datasheet - Web Version 1.0 Rev. A



Mechanical Drawing

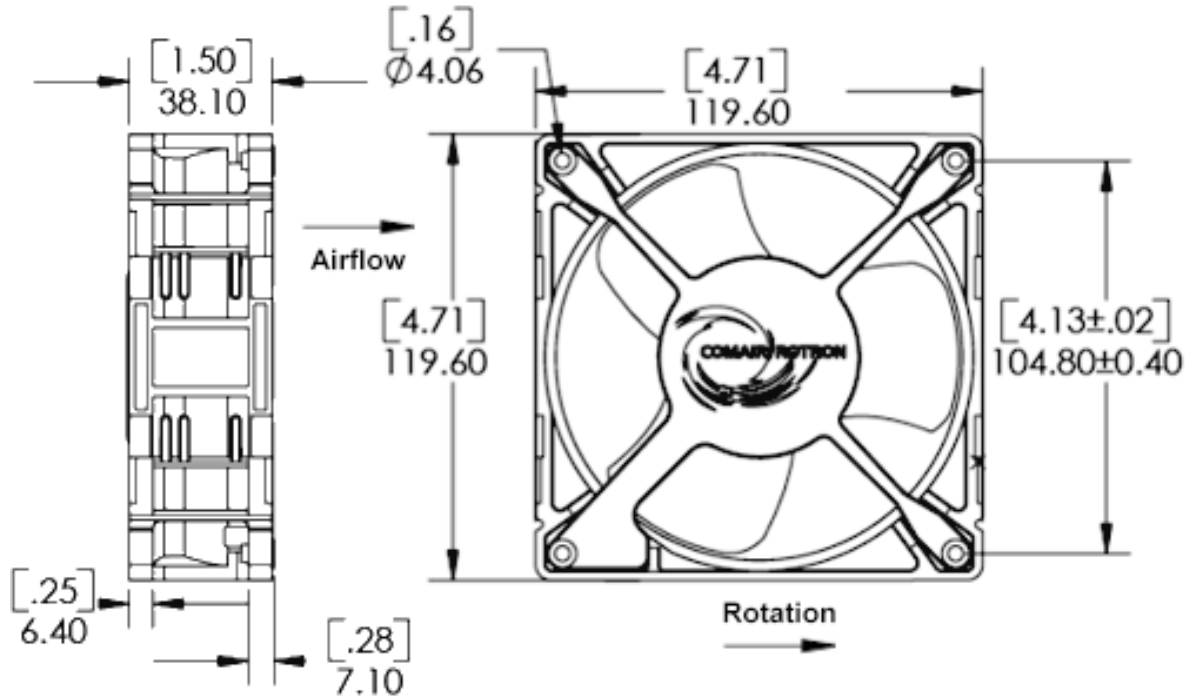

Options

Part Number	Model Number	Bearing Type	Fan Rotation	Termination	In-Stock (Click 'Yes' for current stock)
028029	MU3B1	Ball	Normal	Terminals	No
028030	MU3B2	Ball	Normal	Terminals, No Venturi	No
039713	MU3B4	Ball	Reverse	Terminals, No Venturi	No
028023	MU3A1	Sleeve	Normal	Terminals	No
028024	MU3A2	Sleeve	Normal	Terminals, No Venturi	No
032876	MU3A4	Sleeve	Reverse	Terminals, No Venturi	No

Accessories [\(Click on part number for detailed drawing.\)](#)

428056
Plug and Cord

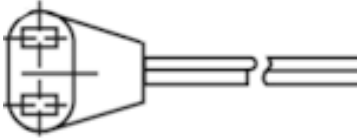

477663
Mounting Clip

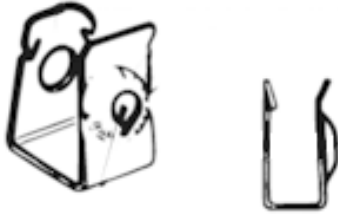

551590
Filter Assembly

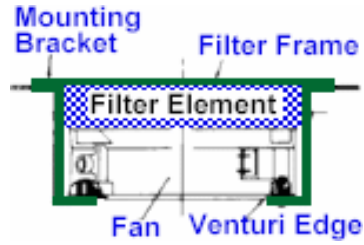

554148
Filter Guard Assembly

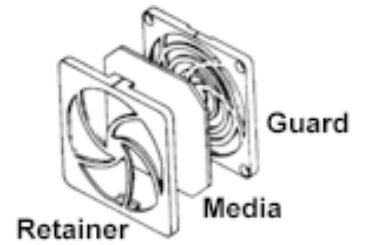

552934
Finger Guard

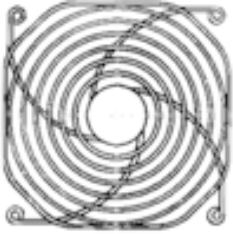

476042
Finger Guard

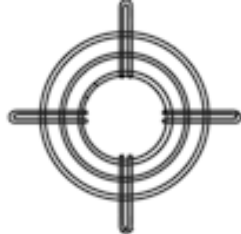

550481
Finger Guard

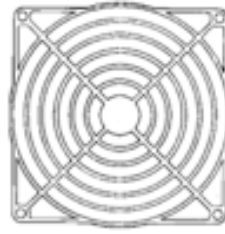

551147
Finger Guard



Comair Rotron, Inc.
Phone: 858.348.6200
sales@comairrotron.com

Comair Rotron Europe, Ltd.
Phone: +44.1527.520525
saleseurope@comairrotron.com

Comair Rotron Fan Company Ltd.
Phone: +86.21.52260581
salesasia@comairrotron.com