

MODULAR HIGH POWER SERIES

FROM 500 TO 4000 WATTS

RELIABILITY

- Demonstrated DC output module MTBF of greater than 5 million hours.
- Ruggedized AC input sections incorporate extensive transient protection.
- Vibration tested at 6 GRMS, 3 axis, 10Hz to 2000Hz.
- Two year warranty.



FLEXIBILITY

- Modular construction; over 10 million configurations available.
- Up to 21 outputs per power supply from 1.0 to 48VDC.
- Parallelable outputs with current sharing.
- System inhibit and individual module output inhibit capability.
- Metric mounting available on selected models.

PERFORMANCE

- Single outputs fully regulated and isolated.
- PFC models meet EN61000-3-2 and EN60555-2.
- EN60950/UL1950 approved. CE Marked to the Low Voltage Directive.
- No minimum loads required on most outputs.



MODULAR HIGH POWER SERIES PRODUCT OVERVIEW

CHASSIS	METRIC MOUNTING STANDARD	SMF3 SPF3	HMF3 HPF3	HMF5 HPF5	SMM2 SPM2	SMM3 SPM3	SMM5 SPM5	HMM5 HPM5	HMM7 HPM7	RMM5 RPM5
OUTPUT POWER AND POWER FACTOR										
.99 PFC to meet EN60555		YES	YES	YES	N/A	N/A	N/A	N/A	N/A	N/A
Max output wattage at high range line input		1350	2000	2000	500	1000	1500	2000	2500	4000
Max output wattage at low range line input*		1000	1500	1500	500	1000	1500	N/A	N/A	N/A
INPUT VOLTAGE SPECIFICATIONS**										
High range VAC input		160-264	160-264	160-264	175-264	175-264	175-264	180-264	180-264	180-264
Low range VAC input		85-159	85-159	85-159	90-132	90-132	90-132	N/A	N/A	N/A
VAC input selection		Wide Range	Wide Range	Wide Range	Manual	Manual	Manual	N/A	N/A	N/A
VAC input phases		single	single	single	single	single	single	single	single	three
OUTPUT MODULE SPECIFICATIONS										
Max # of outputs		9	9	15	6	9	15	15	21	15
# of module slots		3	3	5	2	3	5	5	7	5
MECHANICAL SPECIFICATIONS										
Chassis size H x W x L, inches		5 x 5.5 x 12.5	5 x 5.5 x 12.5	5 x 8 x 11	5 x 3 x 11	5 x 5.5 x 11	5 x 8 x 11	5 x 8 x 11	5 x 11 x 13	5 x 8 x 15
Chassis size H x W		127 x 140	127 x 140	127 x 203	127 x 76	127 x 140	127 x 203	127 x 203	127 x 280	127 x 203
x L, millimeters		x 318	x 318	x 280	x 280	x 280	x 280	x 280	x 330	x 381
INPUT TRANSIENT PROTECTION SPECIFICATIONS										
ESD Immunity EN61000-4-2,		Level 4 15kV/8kV	Level 4 15kV/8kV	Level 4 15kV/8kV	Consult Factory	Level 4 15kV/8kV	Level 4 15kV/8kV	Level 4 15kV/8kV	Level 4 15kV/8kV	Level 4 15kV/8kV
RF Susceptibility EN61000-4-3		Level 3 10V/m	Level 3 10V/m	Level 3 10V/m	Consult Factory	Level 3 10V/m	Level 3 10V/m	Level 3 10V/m	Level 3 10V/m	Level 3 10V/m
Fast Transient/Burst EN61000-4-4		Level 3 ±2kV	Level 3 ±2kV	Level 3 ±2kV	Consult Factory	Level 3 ±2kV	Level 3 ±2kV	Level 3 ±2kV	Level 3 ±2kV	Level 3 ±2kV
Surge Immunity EN61000-4-5 (Line-Line)		Class 4 2kV	Class 4 2kV	Class 4 2kV	Consult Factory	Class 4 2kV	Class 4 2kV	Class 4 2kV	Class 4 2kV	Class 4 2kV
Surge Immunity EN61000-4-5 (line-Gnd)		Class 4 4kV	Class 4 4kV	Class 4 4kV	Consult Factory	Class 4 4kV	Class 4 4kV	Class 4 4kV	Class 4 4kV	Class 4 4kV

*Maximum wattage above 100VAC input for SPF/HPF **Autorange input denotes continuous operation from 85 to 264 VAC

NUCLEAR AND MEDICAL APPLICATIONS Power-One products are not authorized for use as critical components in life support systems, equipment used in hazardous environments, or nuclear control systems without the express written consent of the President of Power-One, Inc.

TECHNICAL REVISIONS The appearance of products, including safety agency certifications pictured on labels, may change depending on the date manufactured. Specifications are subject to change without notice.

MODULAR HIGH POWER SERIES FROM 500 TO 4000 WATTS

SPF3/SMF3*
1350 WATTS
.99 PFC



SPM2/SMM2*
500 WATTS



HPM5/HMM5*
2000 WATTS

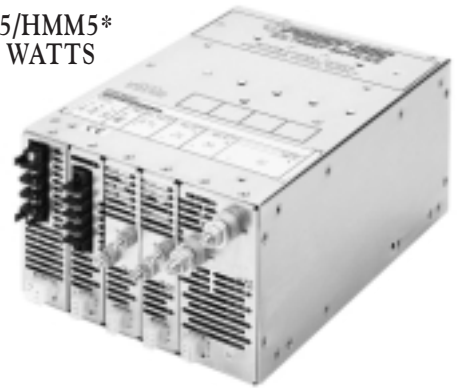

HPF3/HMF3*
2000 WATTS
.99 PFC



SPM3/SMM3*
1000 WATTS



HPM7/HMM7*
2500 WATTS

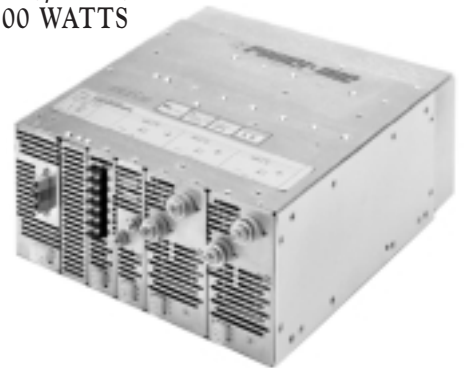

HPF5/HMF5*
2000 WATTS
.99 PFC

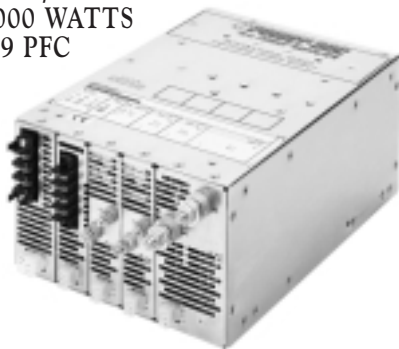

SPM5/SMM5*
1500 WATTS

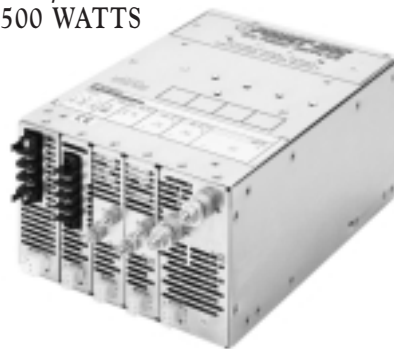

RPM5/RMM5*
4000 WATTS
3 PHASE
INPUT

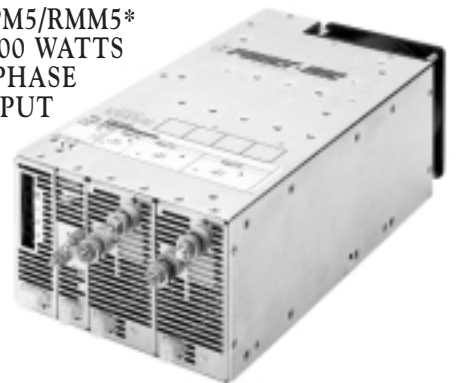

*Metric mounting models meet all performance specifications of models with SAE mounting inserts.

MODULAR HIGH POWER SERIES

FROM 500 TO 4000 WATTS

SYSTEM BLOCK DIAGRAM

The Modular High Power Series products are modular power systems using separate switch-mode DC Output Modules to provide the voltage and current ratings required by each specific application.

The system is based on a 300 VDC System Power Bus derived from either the AC utility line, or a user supplied 300 VDC source. This 300 VDC bus provides the bulk DC required by each output module for conversion to its specified output voltage and current ratings.

As shown in the block diagram, this independent modular approach provides complete isolation between the outputs, as well as all other system elements. Also, the switching circuitry of each output module is clocked and synchronized by the Sync & Bias Supply section to reduce electrical interference between the outputs.

SELECTION AND CONFIGURATION

The modularity of the International Series High Power products allows the user to specify a power system configured from a wide selection of standard off-the-shelf plug in modules. The power system is delivered completely assembled, burned in, and tested. A part number comprised of a series designation, module listing, and options can be configured as follows:

1. Choose a chassis based on required wattage, number of outputs, and power factor.
2. Select modules following the guidelines in the configuration section.
3. Decide on the options. Standard options are listed in the configuration section. Please call the factory for special requirements, such as logic option cards.

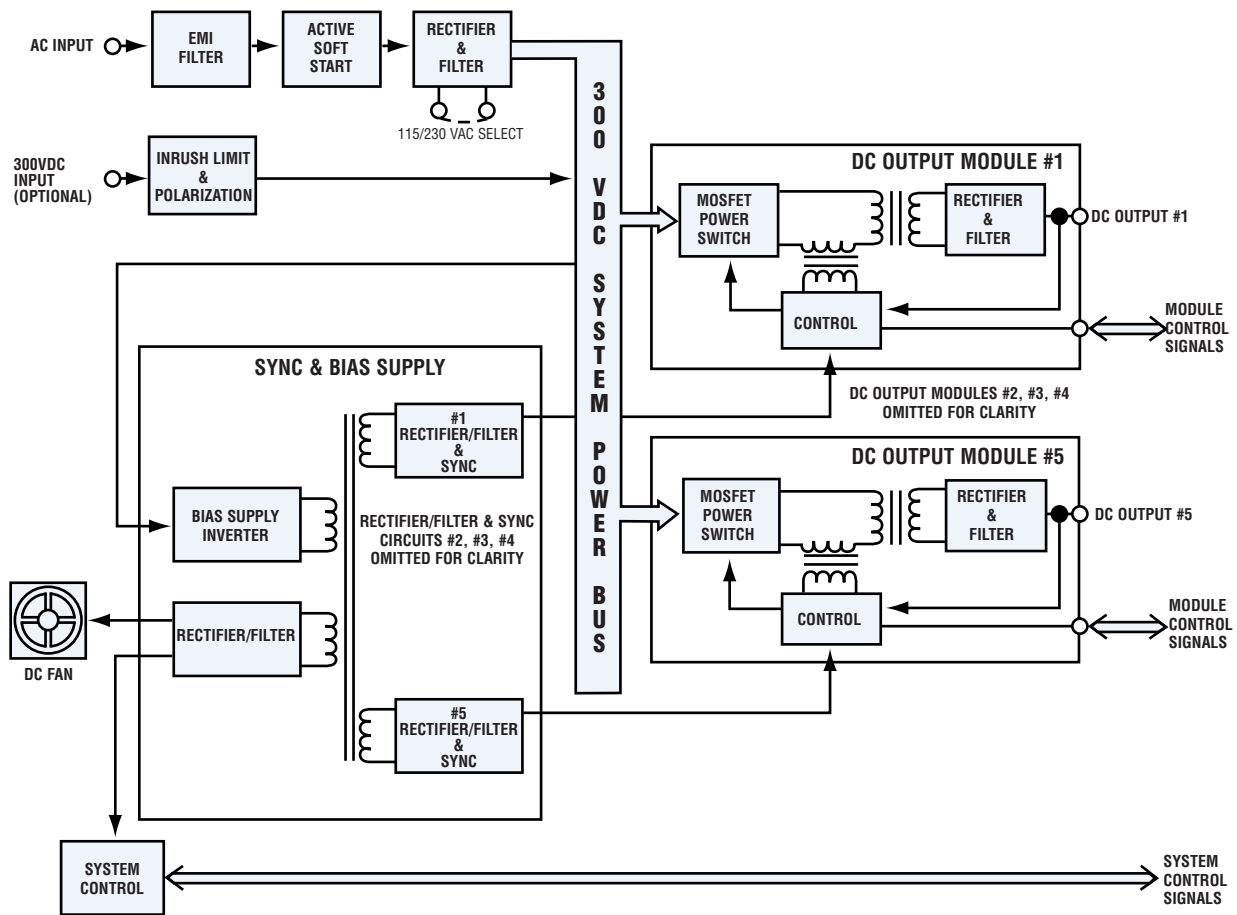

MODULAR HIGH POWER SERIES

SELECTION AND CONFIGURATION

CONFIGURATION NOTES

- Modules are designated in left to right in the part number but are installed right to left in the chassis.
- Single and double wide modules occupy one and two chassis slots respectively. Confirm that the total number of slots required does not exceed the chassis slot capacity.
- Not all modules can be used in all slots. Refer to the compatibility table below.
- Fill blank slots with K or L option.

**EXAMPLE: OUTPUTS SELECTED 5V @ 150A
 12V @ 20A
 -12V @ 20A**

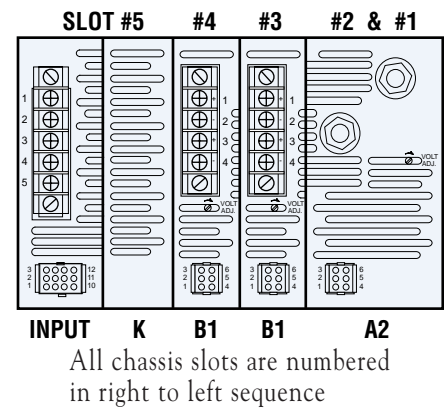
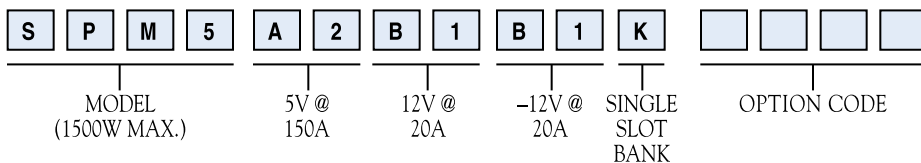

STANDARD OPTIONS

SYSTEM INHIBIT (OPT A, B & C)			INPUT POWER FAIL WARNING (OPT M, N & P)		OTHER OPTIONS							
POWER OUTPUT			OPTION	SIGNAL OUTPUT	OPTION	SIGNAL OUTPUT						
OPTION	INHIBIT	ENABLE	Std		N							
Std	Logic Low	Open Ckt. or Logic High					M	Lo To Hi Transition	P			
A	Logic High	Open Ckt. or Logic Low									K - Single Width Slot Blank	
B	Open Ckt. or Logic High	Logic Low										L - Double Width Slot Blank
C	Open Ckt. or Logic Low	Logic High										

MODULE AND CHASSIS COMPATIBILITY

Confirm that the number listed in the compatibility column of the module selector guide is equal to or less than the lowest number specified for the module slots pictured below. Example: The SPF3 can only use modules with a slot compatibility of 1 in

the slot closest to the input section but can use any module with a compatibility number of four or less in the two other slots. Bold lines designate adjoining slots that can be used for double wide modules.

SPF3/SMF3/HPF3/HMF3			HPF5/HMF5					RPM5												
INPUT	1	≤ 4	≤ 4	INPUT	1	≤ 4	≤ 3	≤ 4	≤ 4	INPUT	≤ 5	≤ 5	≤ 5	≤ 5	≤ 5					
SPM2			SPM3			SPM5/HPM5				HPM7										
INPUT	1	1	INPUT	1	≤ 2	≤ 2	INPUT	1	≤ 4	≤ 3	≤ 4	≤ 4	INPUT	1	≤ 4	≤ 4	≤ 4	≤ 4	≤ 4	≤ 4

MODULAR HIGH POWER SERIES

MODULE SELECTOR GUIDE

SINGLE VOLTAGE OUTPUT MODULES – SEE MECHANICAL DRAWINGS FOR OUTPUT CONNECTION DETAILS, STARTING ON PAGE A69

NOMINAL VOLTAGE	CURRENT (AMPS) @ 50°C (NOTE G)	MODULE	SLOTS USED	SLOT COMPATIBILITY	NOISE & RIPPLE (mV PK-PK) TYPICAL (NOTE A)	NOISE & RIPPLE (mV PK-PK) MAXIMUM (NOTE A)	OUTPUT CONNECTION
1.0V	320	ER	2	5	30	100	Type III
1.5V/1.8V	35	T1 (Note K)	1	1	30	50	Type II
1.5V/1.8V	60	T6 (Note K)	1	1	30	50	Type I
1.5V/1.8V	250	T4 (Note K)	2	2	30	50	Type III
2.0V	80	F8	1	3	25	40	Type I
2V/2.2V	35	F1 (Note J)	1	1	20	50	Type II
2V/2.2V	60	AG (Note B, J)	1	1	30	50	Type I
2V/2.2V	60	F6 (Note J)	1	1	30	50	Type I
2V/2.2V	150	F2 (Note J)	2	2	30	50	Type III
2V/2.2V	180	CS (Note J)	2	5	30	50	Type III
2V/2.2V	250	F4 (Note J)	2	2	30	50	Type III
2V/2.2V	320	F7 (Note J)	2	5	30	100	Type III
2V/2.2V	375	QF (Note B, I)	2	5	30	50	Type III
2.3V	35	BJ	1	1	30	50	Type II
3.3V	35	H1	1	1	30	50	Type II
3.3V	60	H6	1	1	30	50	Type I
3.3V	80	H8	1	3	40	50	Type I
3.3V	90	DA	1	5	30	50	Type I
3.3V	150	H2	2	2	30	40	Type III
3.3V	250	H4	2	2	30	50	Type III
3.3V	320	H7	2	5	50	100	Type III
5V	35	A1	1	1	35	50	Type II
5V	60	A6	1	1	15	50	Type I
5V	80	A8	1	3	15	50	Type I
5V	90	DT	1	5	15	50	Type I
5V	150	A2	2	2	30	50	Type III
5V	220/250	A4 (Note H)	2	3/4	30	50	Type III
5V	320	A7	2	5	30	100	Type III
5V	375	QA	2	5	30	50	Type III
6V	35	AU	1	1	65	90	Type II
6V	100	CT	1	5	40	60	Type I
6V	120	BY	2	2	40	60	Type III
6V	250	CU	2	5	40	100	Type III
8V	65	AJ	2	2	53	80	Type III
10V	20	AW	1	1	66	100	Type II
10V	40	BE	1	3	40	60	Type I
10V	50	CV	1	5	66	100	Type I
10V	65	AQ	2	2	66	100	Type III
10V	160	CW	2	5	100	200	Type III
12V	20	B1	1	1	80	120	Type II
12V	40	B6	1	3	40	60	Type I
12V	65	B2	2	2	80	120	Type III
12V	80	BC	2	3	80	120	Type III
12V	135	DE	2	5	120	240	Type III
15V	16	AF (Note C)	1	1	15	35	Type II
15V	16	C1	1	1	100	150	Type II
15V	33	C6	1	3	30	60	Type I
15V	50	C5	1	5	100	150	Type I
15V	52	C2	2	2	100	150	Type III
24V	10	D1	1	1	160	240	Type II
24V	15	D6	1	2	80	120	Type II
24V	29	D8	1	4	60	100	Type I
24V	32	D2	2	2	160	240	Type III
24V	33	D5	1	5	60	100	Type I
28V	8.6	E1	1	1	200	280	Type II
28V	26	E8	1	4	70	100	Type I
28V	27	E2	2	2	150	280	Type III
28V	29	E5	1	5	70	100	Type I
36V	20	J8	1	4	100	200	Type I
36V	21	J2	2	2	100	200	Type III
36V	23	J5	1	5	100	200	Type I
48V	5	G1	1	1	400	480	Type II
48V	12.5	G4 (Note C)	1	3	40	60	Type I
48V	16	G2	2	2	135	200	Type III
48V	16	G8	1	4	60	100	Type I
48V	19	G6	1	5	60	100	Type I

MODULAR HIGH POWER SERIES

MODULE SELECTOR GUIDE

SINGLE OUTPUT, VARIABLE VOLTAGE MODULES

NOMINAL VOLTAGE	CURRENT (AMPS) @ 50°C (NOTE G)	MODULE	SLOTS USED	SLOT COMPATIBILITY	NOISE & RIPPLE (mV PK-PK) TYPICAL (NOTE A)	NOISE & RIPPLE (mV PK-PK) MAXIMUM (NOTE A)	OUTPUT CONNECTION
1.0V to 1.8V	320	ER	2	5	30	100	Type III
1.5V to 2.8V	375	QF (Note B)	2	5	50	50	Type III
1.9V to 3V	150	AB	2	2	50	50	Type III
14V to 24V	10	W1	1	1	80	120	Type II
14v to 24V	32	BS	2	2	135	200	Type III

DUAL VOLTAGE OUTPUT MODULES

NOMINAL VOLTAGE	CURRENT (AMPS) @ 50°C (NOTE G)	MODULE	SLOTS USED	SLOT COMPATIBILITY	NOISE & RIPPLE (mV PK-PK) TYPICAL (NOTE A)	NOISE & RIPPLE (mV PK-PK) MAXIMUM (NOTE A)	OUTPUT CONNECTION
12/12	10/4	M4 (Note D)	1	1	120	240	Type II
±12	10/10	B4 (Note E)	1	1	120	240	Type II
±15	8/8	C4 (Note E)	1	1	150	300	Type II
±20	5/5	BQ (Note E)	1	1	80	100	Type II
±24	5/5	D4 (Note E)	1	1	80	120	Type II

TRIPLE OUTPUT VOLTAGE MODULES (Note D)

NOMINAL VOLTAGE	CURRENT (AMPS) @ 50°C (NOTE G)	MODULE	SLOTS USED	SLOT COMPATIBILITY	NOISE & RIPPLE (mV PK-PK) TYPICAL (NOTE A)	NOISE & RIPPLE (mV PK-PK) MAXIMUM (NOTE A)	OUTPUT CONNECTION
5/1.5/12	10/10/10	CA	1	1	N/A	100/100/120	Type II
5/2.2/12	10/10/10	W6	1	1	N/A	100/100/120	Type II
5/12/12	10/10/10	M6	1	1	N/A	50/120/120	Type II
5.2/12/12	15/8/8	BA	1	1	N/A	100/180/180	Type II
5.2/12/12	5/16/7	AE	1	1	N/A	60/160/120	Type II
5/12/24	10/10/5	U6	1	1	N/A	50/120/240	Type II
5/15/15	10/8/8	V6	1	1	N/A	50/150/150	Type II
5/24/24	10/5/5	R6	1	1	N/A	50/240/240	Type II
12/12/12	10/10/10	N6	1	1	N/A	120/120/120	Type II
5/15/12	10/8/10	EC	1	1	N/A	50/150/120	Type II
24/12/12	5/10/10	P6	1	1	N/A	240/120/120	Type II

- NOTES:**
- A) The output noise and ripple measurement is bandwidth limited to 20MHz.
 - B) Module is designed to accommodate output cable losses of up to one volt.
 - C) Module is designed for use in applications demanding low noise and ripple. Consult factory for further specifications.
 - D) All triple output modules, as well as the M4 dual output module, have floating outputs. Like voltages may be shared within the same module. All triple output adjustments and interface signals are for output #1. Consult factory for more information.
 - E) The dedicated negative (-) output is quasiregulated. Both outputs require a small minimum load to perform to specification. Consult factory for more information.
 - G) For ambient temperatures above 50°C, output current must be linearly derated to 50% at the maximum operational ambient temperature, 70°C.
 - H) A4 module provides 220A in chassis with slot compatibility rating of 3, and 250A in chassis with slot compatibility rating of 4.
 - I) Module output is wide range adjustable from 1.5 to 2.8 volts, factory preset to 2.0 volts.
 - J) Module output is factory set to 2.0 volts. Output voltage will adjust +10% to 2.2 volts.
 - K) Modules do not adjust -10% below 1.5V or +10% above 1.8V. Consult factory.

MODULAR HIGH POWER SERIES PARALLELED MODULE CONFIGURATIONS

For applications that require an output current greater than listed in the Module Selector Guide, it is possible to achieve greater output through the paralleling of multiple single output modules. A performance aspect of the high power modular construction allows for paralleling of common voltage modules of the same or different current ratings for increased output capability. By connecting additional modules in parallel, it is possible to attain output currents up to 730A. All paralleling designations include factory-installed bus bars, as well as internally connected current sharing. Please consult factory for paralleling configurations not shown.

- Choose appropriate chassis and modules as shown in Selection and Configuration.
- Note the output connection type as shown in the Module Selector Guide.
- Select the paralleling suffix that corresponds to the selected output modules.
- NOTE: Paralleling suffix follows after all other option codes.

CHASSIS	CHASSIS SLOT						PARALLELING SUFFIX		
	7	6	5	4	3	2		1	
3 SLOT CHASSIS: SPM3, SPF3, SMF3, HPF3, HMF3						I	I	YA	
					I	I	I	YB	
					II	I	I	YC	
					I	III		YD	
					II	III		YE	
5 SLOT CHASSIS: SPM5, HPM5, HPF5, HMF5, RPM5						I	I	YF	
					I	I	I	YG	
				I	N/U	I	I	YJ	
				I	I	I	I	YJ	
			II	I	I	I	I	YM	
			I	I	I	I	I	YN	
					I	III		YP	
					III	III		YH	
			II	III	III			YR	
		I	III	III			YS		
7 SLOT CHASSIS: HPM7						I	I	YF	
						I	I	YG	
					I	N/U	I	YJ	
					I	I	I	YJ	
					I	I	I	YN	
					I	III		YP	
					III	III		YH	
				I	III	III		YS	
			III	III	III			YT	

EXAMPLE: REQUIREMENT: 5V @ 300A

- Select Chassis: HPF3
- Select Modules: A4 (5V @ 250A), A6 (5V @ 60A)
- Choose Corresponding Paralleling Suffix: YD
- Final Part Number: HPF3A4A6YD

LIMITATIONS FOR STANDARD PARALLELING SYSTEM

- Single output modules only
- Ripple and Noise limit will be 20% over the largest value paralleled

LEGEND

Type I = #10-32 studs
 Type II = Barrier Block
 Type III = 5/16"-18 studs

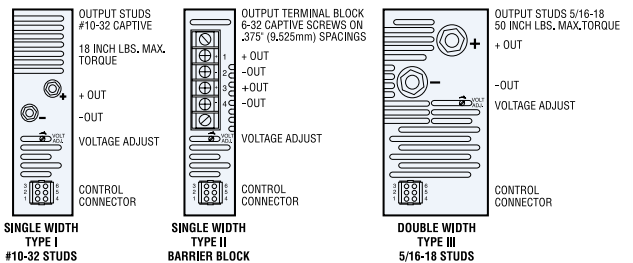

MODULAR HIGH POWER SERIES

DC OUTPUT MODULE SPECIFICATIONS

SINGLE AND DUAL OUTPUT MODULES

PARAMETER	CONDITIONS/DESCRIPTION	MIN	NOM	MAX	UNITS
Output Voltage Adjustment Range		-10		+10	%
Output Current	At 0°C to 50°C ambient.	See Module Selector Guide.			
Ambient Temperature Range	100% rated load.	0		50	°C
	Derated linearly to 50% load.	0		70	
Initial Voltage Setting	Factory set.	-1		+1	%
Output Voltage Adjustment		-10		+10	%
Margining/Remote Voltage Adjustment	Range.	-10		+10	%
	Programming sensitivity from 2.0V.	-4	-5	-6	%/V
Remote Voltage Sense	Total cable drop.			0.5	V
Temperature Coefficient	0 to 50 °C after initial 1 hour warmup.		0.01	0.02	%/°C
Long Term Voltage Drift	1000 hours.			0.1%	
Line Regulation	Over input operating range.		0.05	0.1	%
Load Regulation Single Output Modules	≤ 5 Volt Modules				
	0% to 100% load with remote sense.		< 10		mV
	0% to 100% load without remote sense.		< 60		mV
Consult Factory For Specific Ratings	> 5 Volt Modules				
	0% to 100% load with remote sense.		< 30		mV
	0% to 100% load without remote sense.		< 75		mV
Cross Regulation Between Single Output Modules in One Chassis	0% to 100% load change.			0	%
Load Regulation, Dual Output Modules	Positive Output				
	0% to 100% load with remote sense.		< 30		mV
	0% to 100% load without remote sense.		< 75		mV
Load Regulation, Dual Output Modules	Negative Output				
	0% to 100% load.			5	%
Cross Regulation, Dual Output Modules	Positive Output				
	0% to 100% load change.			0.1	mV
Cross Regulation, Dual Output Modules	Negative Output				
	10% to 100% load change.			5	%
Minimum Load Current	Dual output modules only. See factory data sheets.	1			Amp
Current Limit	Factory set. As a % of full rated I _o . Dual output modules use primary power limiting. See module ratings.	110%	115%	120%	Amp
Short Circuit Current	As a % of full rated I _o .		100%		Amp
Current Sharing	Current sharing accuracy as a % of full rated I _o .			1	%
Overvoltage Protection	Trip point as a % of V _o ≥ 5V. Resettable by recycling input.	115%	120%	125%	V
Reverse Polarity Protection	Reverse current as a % of full rated I _o . Reverse voltage externally applied.			100%	Amp
Inhibit	Logic LO = off			0.9	V
	Sink current.			0.4	mA
	Logic HI = on	2			V
	Source current.			20	μA
Output Good Signal	Logic LO (when V _o deviates ±3% to ±5% from adjusted set point).			0.9	V
	Sink current.			40	mA
	Logic HI (with internal pull-up to 5V).		1.5		kΩ
Noise and Ripple	20MHz bandwidth.	See module ratings.			mVPP
Transient Response	75% to 100% load step.			2%	mV _{PK}
	50% to 100% load step.			4%	
	Recovering to 1% within 400 μSec, Slew rate = 1A/μSec.				
Turn-On Delay	After input applied.			1	Sec
	After inhibit released.			50	mS
Rise Time	5% to 95% of V _o .			50	mS
Overshoot	Overshoot as a % of V _o at turn on.			0%	V
Turn-Off Delay	After inhibit or OVP trip.			500	μS

Specifications in this section are general and may vary according to specific modules.

MODULAR HIGH POWER SERIES

DC OUTPUT MODULE SPECIFICATIONS

TRIPLE OUTPUT MODULES

PARAMETER	CONDITIONS/DESCRIPTION	OUTPUT #1			OUTPUT #2			OUTPUT #3			UNITS	
		MIN.	NOM.	MAX.	MIN.	NOM.	MAX.	MIN.	NOM.	MAX.		
Output Current	At 0°C to 50°C ambient.	See module ratings.										
Ambient Temperature Range	100% rated load. Derated linearly to 50% load.	0		50	0		50	0		50	°C	
				70			70			70		
Initial Voltage Setting	Initial voltage set point as a % of Vo.	-1%		+1%	-1%		+1%	-1%		+1%	V	
Output Voltage Adjustment Range		-10%		+10%	-10%		+10%	-10%		+10%	V	
Margining/Remote Voltage Adjustment	Range. Programming sensitivity, from 2.5V.	-10%		+10%							V %/V	
		-4		-5								
Remote Voltage Sense	Total cable drop.			0.5							V	
Temperature Coefficient	0 to 50 °C after initial 1 hour warmup.		0.01	0.02		0.01	0.02		0.01	0.02	%/°C	
Long Term Voltage Drift	1000 hours.			0.1%			0.1%			0.1%		
Line Regulation	Over input operating range.		0.05	0.1		0.05	0.1		0.05	0.1	%	
Load Regulation	0% to 100% load w/remote sense			0.1		0.2					%	
	0% to 100% load w/o remote sense (Note 1)		1	5		1	5		1	5	mV/Amp	
Cross Regulation	0% to 100% load change.			0		0			0	0	%	
Minimum Load Current				0		0			0	0	Amp	
Current Limit	Factory set. As a % of full rated Io.	105%		120%	105%		120%	105%		120%	Amp	
Short Circuit Current	As a % of full rated Io.			100%			100%			100%	Amp	
Current Sharing (Note 2)	Current sharing accuracy as a % of full rated Io. Factory calibrated at 100% load.			5			5			5	%	
Reverse Voltage Protection	Reverse current as a % of full rated Io. Reverse voltage externally applied.			100%			100%			100%	Amp	
Inhibit	Logic LO = off Sink current.			0.4							V mA	
	Logic HI = on Source current.	2.5		20							V µA	
Output Fault Signal	Logic low upon current limit detection, OVP, or shut down.											
	Logic LO (with 3 mA sink).			0.7			0.7			0.7	V	
	Logic HI (with internal pull-up to 5V)		5.1			5.1			5.1		kΩ	
Turn-On Delay	After input applied.			1			1			1	Sec	
	After inhibit released.			50			50			50	mS	
Rise Time	5% to 95% of Vo.			50			50			50	mS	
Overshoot	Overshoot as a % of Vo.			3%			3%			3%	V	
Turn-Off Delay	After inhibit or OVP trip.			500			500			500	µS	
Overvoltage Protection	Provided on output #1 only. Trip point as a % of Vo.											
Resettable by recycling input.												
Noise and Ripple	20 MHz bandwidth.	5V Output: 130%, ±5% of Vo. 12V Output: 120%, ±5% of Vo. 24V Output: 115%, ±5% of Vo.										
		Output Voltage Vo									5V 12V 15V 24V	
	NOM.									65 80 100 160	mVPP	
	MAX.									100 120 150 240		
	NOM.									20 20 25 40	mVRMS	
	MAX.									30 30 38 60		
Transient Response	75% to 100% load change @ 0.4A/µS.	Output Voltage Vo									5V 12V 15V 24V	
											150 240 240 480	mVPP
	50% to 100% load change @ 0.4A/µS. Recovery to 1% within 400 µS										300 480 480 960	

NOTES: 1) 20 mV max below 5% load.

2) Identical voltages can be paralleled at the factory. Please consult the factory.

SPF3 / SMF3* HPF3 / HMF3* HPF5 / HMF5*

INPUT

PARAMETER	CONDITIONS	MIN.	NOM.	MAX.	UNITS
Input Voltage	AC Input	85		264	VAC
Input Current	$\eta=70\%$ 115 VAC; 1000W 115 VAC; 1300W 115 VAC; 1500W 230 VAC; 1350W 230 VAC; 1500W 230 VAC; 2000W			12.8 16.2 19.2 8.6 9.6 12.8	ARMS
Power Factor	85 - 264 VAC; >500W (SPF3, HPF3, HPF5) 85 - 264 VAC; >1300W (HPF3, HPF5)	0.98 0.98			W/VA
Inrush Surge Current	V _{in} = 132VAC (one cycle) V _{in} = 264VAC (one cycle)			20 40	APK
Input Frequency	AC Input	47		63	Hz
Start Up Time	From time AC is applied to V _{out} is in regulation			1.5	Sec
Hold-up Time	85- 264VAC at rated maximum power	23			mS
Input Power Fail Warning	Logic signal time before regulation dropout due to loss of input power	5			mS
Overtemperature Warning	Advance warning before shutdown	10			mS

SAFETY AND EMI

Agency Approvals	UL1950 CSA 22.2 No. 950 EN60950 (TUV)				
Line Harmonic Disturbance	EN60555-2 EN61000-3-2				
Dielectric Withstand Voltage	Input to Output ("Y" capacitors disconnected) Input to Chassis Output to Chassis	4300 2300 500			VDC
Leakage Current	Per UL1950 and CSA 22.2 No. 950 Per EN60950			1.5 2.5	mA
Electromagnetic Interference	FCC CFR title 47 Part 15, Sub-Part B Conducted EN55022 / CISPR 22, Conducted			Level A	

GENERAL

Output Power	SPF3 Full Load, 85-100 VAC input SPF3 Full Load, 101-159 VAC input SPF3 Full Load, 160-264 VAC input HPF3/HPF5 Full Load, 85-100 VAC input HPF3/HPF5 Full Load, 101-159 VAC input HPF3/HPF5 Full Load, 160-264 VAC input			875 1000 1350 1300 1500 2000	Watts
Efficiency	Full Load, Nominal Line Input		75		%
Vibration	Random Vibration, 10Hz to 2KHz, 3 axis			6	GRMS
Shock	Operating, peak acceleration			20	GPK
Operating Temperature	At 100% load Derate linearly above 50°C to 50%	0		50 70	°C
Storage Temperature		-40		85	°C
Altitude	Operating Non-Operating			10,000 50,000	Feet
Relative Humidity	Non-Condensing			95	%
Acoustical Noise	"A" Weighted @ 1 meter			50	dB
Cooling	Static pressure through system enclosure			0.05	In of H ₂ O

*Metric mounting chassis meet all specifications of non-metric models.

SPM2 / SMM2* SPM3 / SMM3*

INPUT

PARAMETER	CONDITIONS	MIN.	NOM.	MAX.	UNITS
Input Voltage	AC Input				
	Low range	90	115	132	VAC
	High range	175	230	264	VAC
	DC Input	250	300	350	VDC
Input Current	SPM2 500Watt Load				
	Vin = 90 VAC			13	ARMS
	Vin = 175 VAC			6.3	ARMS
	Vin = 250 VDC			3	ADC
	SPM3 1000Watt Load				
	Vin = 90 VAC			25	ARMS
	Vin = 175 VAC			13	ARMS
	Vin = 250 VDC			3	ADC
Inrush Surge Current	SPM2				
	Vin = 132 VAC			60	APK
	Vin = 264 VAC			60	APK
	SPM3				
	Vin = 132 VAC			19	APK
	Vin = 264 VAC			38	APK
Input Frequency	With AC Input	47		440	Hz
Hold-up Time	After last AC line peak with 115/230 VAC Input	23			mS
Input Power Fail Warning	Logic signal before regulation dropout due to loss of input power	5			mS
Overtemperature Shutdown	System shutdown due to excessive internal temperature	75		85	°C
Thermal Warning	Advanced warning before overtemperature shutdown	10			mS

SAFETY AND EMI

Agency Approvals	UL1950 CSA22.2 #950 EN60950 (TÜV)				
Dielectric Withstand Voltage	Input to Output	4300			VDC
	Input to Chassis	2300			
	Output to Chassis	500			
Insulation Resistance	Input to Output	10			Meg Ω
	Input to Chassis	10			
	Output to Chassis	2			
Leakage Current	SPM2/SPM3			1.75/1.25	mA
Safety Spacing	Primary to Secondary	8			mm
	Primary to Chassis	4			
Electromagnetic Interference	FCC CFR title 47 Part 15, Sub-Part B Conducted EN55022 / CISPR 22, Conducted			Level A	

GENERAL

Output Power (Max)	SPM2			500	Watts
	SPM3			1000	
Efficiency	Full load, typical modules.	75			%
Power Factor	115/230 VAC input		0.7		W/VA
Vibration	Random vibration from 10Hz to 2 KHz, (3 axis)			6.0	GRMS
Shock	Operating: peak acceleration			20	GPK
Operating Temp.	At 100% Load	0		50	°C
	Derate to 50% at 70°C			70	
Storage Temp.		-40		85	°C
Altitude	Operating (Consult factory for operation above 10,000 feet)			10,000	Feet
	Non-operating			50,000	Feet
Relative Humidity	Non-condensing			95	%
Acoustical Noise	"A" weighted, anechoic at 1 meter			50	dB
Cooling	Internal Fan Cooled (At Sea Level)				CFM
	SPM2		25		
	SPM3		50		

*Metric mounting chassis meet all specifications of non-metric models.

SPM5 / SMM5* HPM5 / HMM5* HPM7 / HMM7*

INPUT

PARAMETER	CONDITIONS	MIN.	NOM.	MAX.	UNITS
Input Voltage HPM5/HPM7 Operate Only On High Range	AC Input				
	Low range-SPM5 only	90	115	132	VAC
	High range	175	230	264	VAC
	DC Input				
	DC Input Range	250	300	350	VDC
Input Current	Vin = 90 VAC			2	ARMS/100 Watts Load
	Vin = 175 VAC			1	ARMS/100 Watts Load
	Vin = 250 VDC			0.53	ADC/100 Watts Load
Inrush Surge Current	Vin = 132 VAC			19	APK
	Vin = 264 VAC			38	
Input Frequency	With AC Input	47		440	Hz
Hold-up Time	After last AC line peak with 115/230 VAC Input	30			mS
Input Power Fail Warning	Logic signal before regulation dropout due to loss of input power	3			mS
Thermal Warning	Warning before overtemperature shutdown	10			mS

SAFETY AND EMI

Agency Approvals	UL1950 CSA22.2 #950 EN60950 (TUV)				
Dielectric Withstand Voltage	Input to Output	4300			VDC
	Input to Chassis	2300			
	Output to Chassis	500			
Insulation Resistance	Input to Output	10			Meg Ω
	Input to Chassis	10			
	Output to Chassis	10			
Leakage Current	Per UL1950 and CSA 22.2 No. 950			1.5	mA
	Per EN60950			2.5	
Safety Spacing	Primary to Secondary	8			mm
	Primary to Chassis	4			
Electromagnetic Interference	FCC CFR Title 47 Part 15, Sub-Part B Conducted EN55022 / CISPR 22, Conducted			Level A	

GENERAL

Output Power (Max) - SPM5/HPM5/HPM7				1500/2000/2500	Watts
Efficiency	Full Load		75		%
Power Factor	115/230 VAC input, typical modules.		0.7		W/VA
Vibration	MIL-STD-810D, Method 514.3, Category I, Proc I			6	GRMS
Shock	MIL-STD-810D, Method 516.3, Proc II, IV, VI			20	GPK
Operating Temp.	At 100% Load	0		50	°C
	Derate to 50% at 70°C			70	
Storage Temp.		-40		85	°C
Altitude	Operating (Consult factory for operation above 10,000 feet)			10,000	Feet
	Non-operating			50,000	Feet
Relative Humidity	Non-condensing			95	%
Acoustical Noise	"A" weighted, anechoic at 1 meter			50	dB
Cooling	Internal Fan	80			CFM

*Metric mounting chassis meet all specifications of non-metric models.

RPM5 / RMM5*

INPUT

PARAMETER	CONDITIONS	MIN.	NOM.	MAX.	UNITS
Input Voltage	AC Input Three Phase with Ground Phase to Phase	180	230	264	VAC
	DC Input	250	300	350	VDC
Input Current	180 VAC			23	ARMS
	208 VAC			20	
	220 VAC			19	Adc
	250 VDC			23	
Inrush Surge Current	Vin = 264 VAC (one cycle)			38	APK
Input Frequency	With AC Input	47		63	Hz
Hold-up Time	After last AC line peak				mS
	208 VAC 220 VAC	20 25			
Input Power Fail Warning	Logic signal before regulation dropout due to loss of input power	5			mS
Overtemperature Shutdown	System shutdown due to excessive internal temperature	70	80		°C
Thermal Warning	Advanced warning before shutdown	10			mS

SAFETY AND EMI

Agency Approvals	UL1950 CSA 22.2 No. 950 EN60950 (TÜV)				
Dielectric Withstand Voltage	Input to Output	4300			VDC
	Input to Chassis	2300			
	Output to Chassis	300			
Insulation Resistance	Input to Output	10			Meg Ω
	Input to Chassis	10			
	Output to Chassis	2			
Leakage Current	Per UL1950 and CSA 22.2 No. 950 Per EN60950			1.5 2.5	mA
Electromagnetic Interference	FCC CFR title 47 Part 15, Sub-Part B Conducted EN55022/CISPR 22, Conducted			Level A	

GENERAL

Output Power	Full Load, 230 VAC			4000	Watts
Efficiency	Full Load, 230 VAC		75		%
Power Factor	> 2000 watts @ 60 Hz, > 3000 watts @ 50 Hz		0.9		W/VA
Vibration	Random vibration from 10Hz to 2 KHz, (3 axis)			6	GRMS
Shock	Operating, peak acceleration			20	GPK
Operating Temp.	At 100% Load	0		50	°C
	Derate linearly above 50°C to 50%			70	
Storage Temp.		-40		85	°C
Altitude	Operating			10,000	Feet
	Non-operating			50,000	
Relative Humidity	Non-condensing			95	%
Acoustical Noise	"A" weighted at 1 meter			60	dB
Cooling	Static pressure through system closure			0.05	In of H ₂ O

*Metric mounting chassis meet all specifications of non-metric models.

For the Most Up-To-Date Information

www.power-one.com

24 Hours/Day—7 Days/Week

SPM2 / SMM2* SPM3 / SMM3*

MODEL SPM2 OVERALL SIZE: 5.00" x 3.00" x 11.00" (127.0mm x 76.2mm x 279.4mm) WEIGHT: 8.0 LBS (3.60 kg)

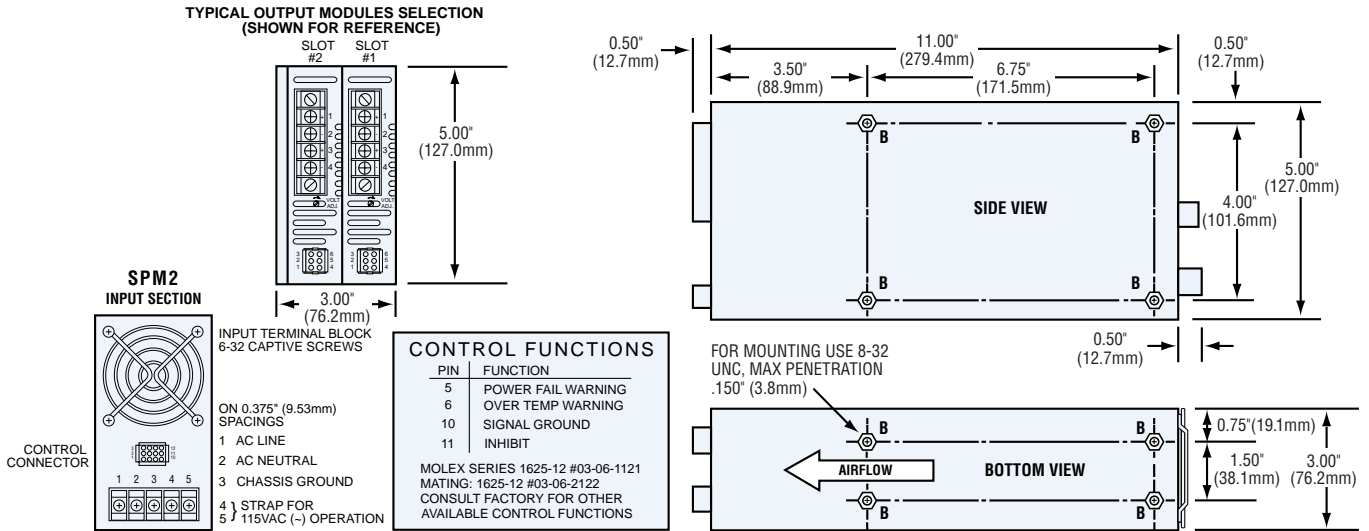

MODEL SPM3 OVERALL SIZE: 5.00" x 5.50" x 11.00" (127.0mm x 139.7mm x 279.4mm) WEIGHT: 10.0 LBS (4.50 kg)

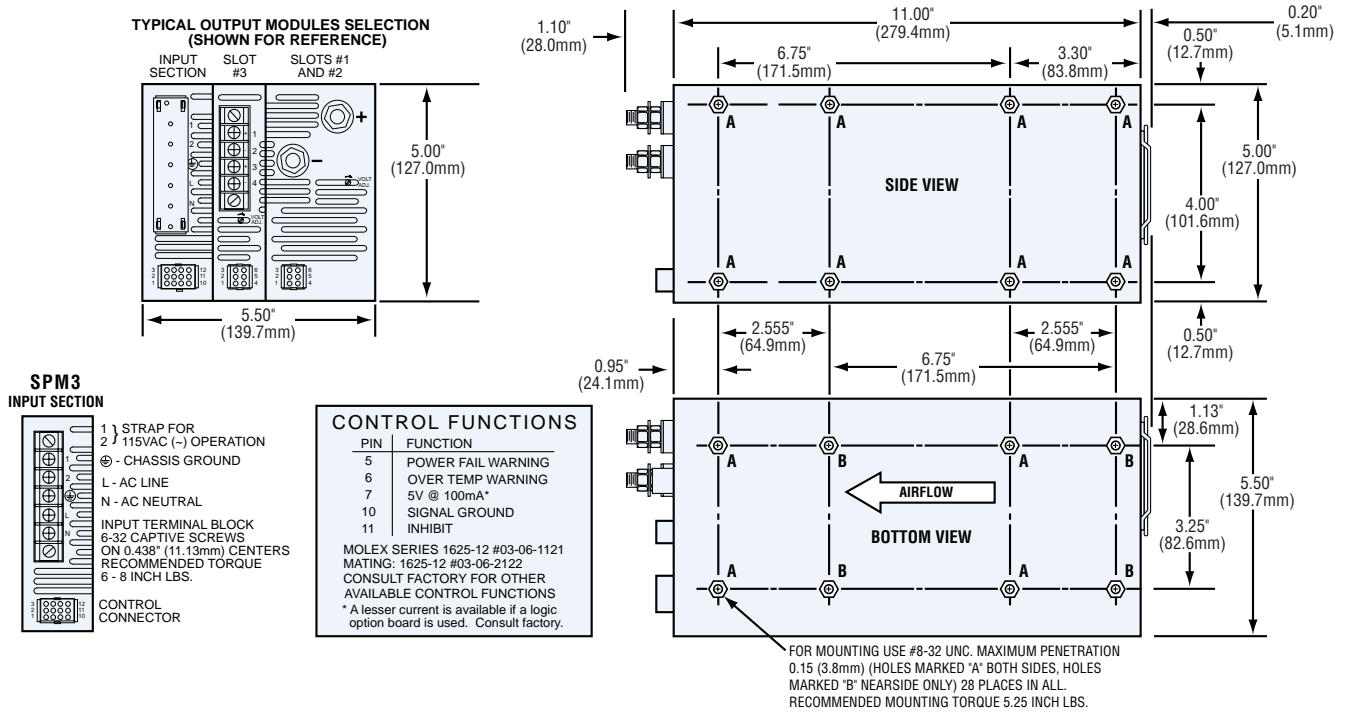

MODEL SPM2 & SPM3 OUTPUT MODULES—CONFIGURATIONS AND INTERFACE SIGNALS

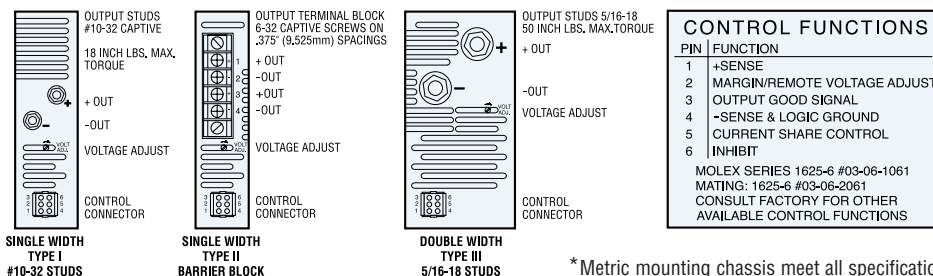

*Metric mounting chassis meet all specifications of non-metric models.

SPF3 / SMF3* HPF3 / HMF3*

OVERALL SIZE: 12.50" x 5.50" x 5.00" (317.5mm x 139.7mm x 127.0mm)

WEIGHT: 12.5 LBS (5.70 kg)

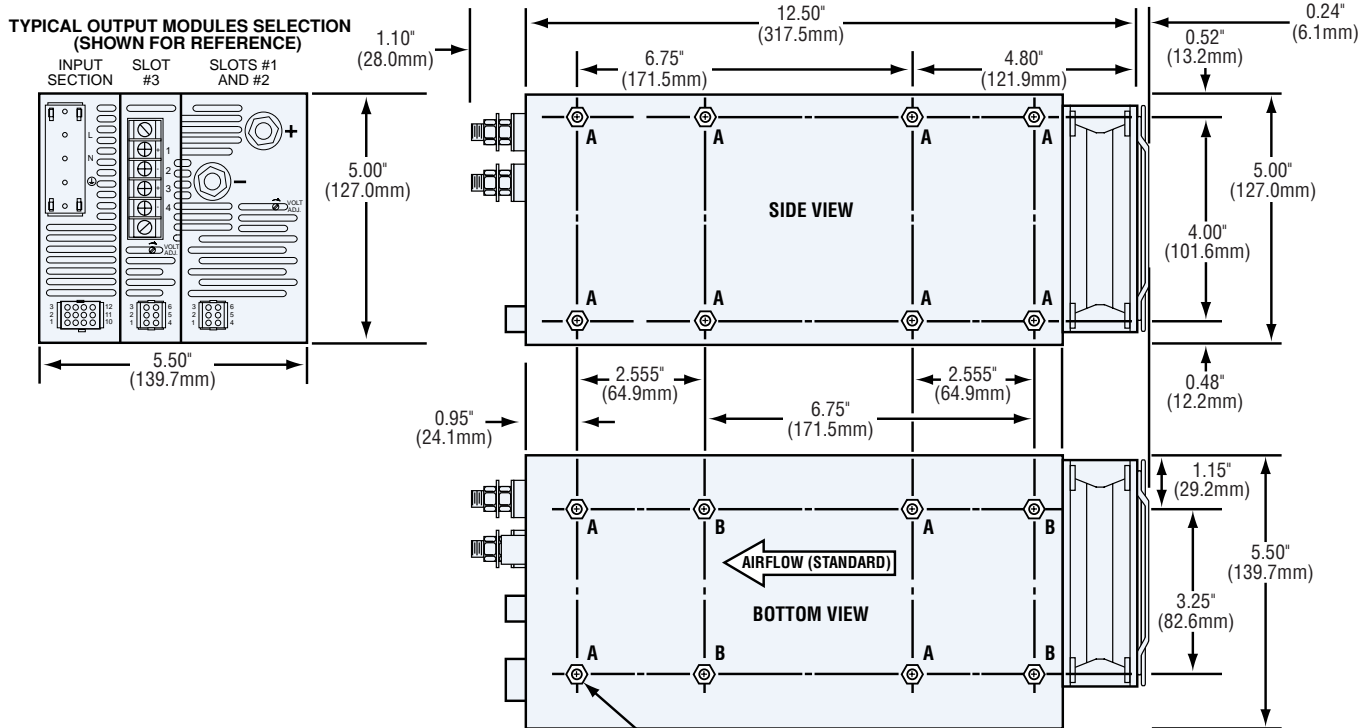

FOR MOUNTING USE #8-32 UNC. (M4 X 0.7 FOR SMF3 AND HMF3)
 MAXIMUM PENETRATION 0.15 (3.8mm) (HOLES MARKED
 "A" BOTH SIDES, HOLES MARKED "B" NEARSIDE ONLY) 28 PLACES IN ALL.
 RECOMMENDED MOUNTING TORQUE 5.25 INCH LBS. (0.32 N/M).

**SPF3/SMF3
 HPF3/HMF3
 INPUT SECTION**

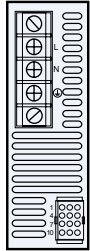

L - AC LINE
 N - AC NEUTRAL
 ⊕ - CHASSIS GROUND

INPUT TERMINAL BLOCK
 6-32 CAPTIVE SCREWS
 ON 0.438" (11.13mm) CENTERS
 RECOMMENDED TORQUE
 6 - 8 INCH LBS.

CONTROL CONNECTOR

CONTROL FUNCTIONS

PIN	FUNCTION
5	POWER FAIL WARNING
6	OVER TEMP WARNING
7	5V @ 100mA*
10	SIGNAL GROUND
11	INHIBIT

MOLEX SERIES 1625-12 #03-06-1121
 MATING: 1625-12 #03-06-2122
 CONSULT FACTORY FOR OTHER
 AVAILABLE CONTROL FUNCTIONS
 * A lesser current is available if a logic
 option board is used. Consult factory.

OUTPUT MODULES—CONFIGURATIONS AND INTERFACE SIGNALS

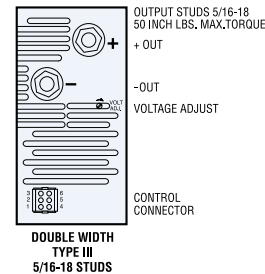
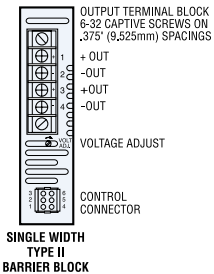
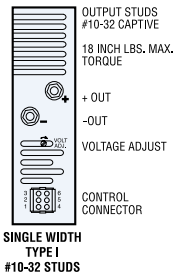

CONTROL FUNCTIONS

PIN	FUNCTION
1	+SENSE
2	MARGIN/REMOTE VOLTAGE ADJUST
3	OUTPUT GOOD SIGNAL
4	-SENSE & LOGIC GROUND
5	CURRENT SHARE CONTROL
6	INHIBIT

MOLEX SERIES 1625-6 #03-06-1061
 MATING: 1625-6 #03-06-2061
 CONSULT FACTORY FOR OTHER
 AVAILABLE CONTROL FUNCTIONS

*Metric mounting chassis meet all specifications of non-metric models.

SPM5 / SMM5* HPF5 / HMF5* HPM5 / HMM5*

OVERALL SIZE: 11.00" x 8.00" x 5.00" (279.4mm x 203.2mm x 127.0mm)
WEIGHT: 15.0 LBS (6.75 kg)

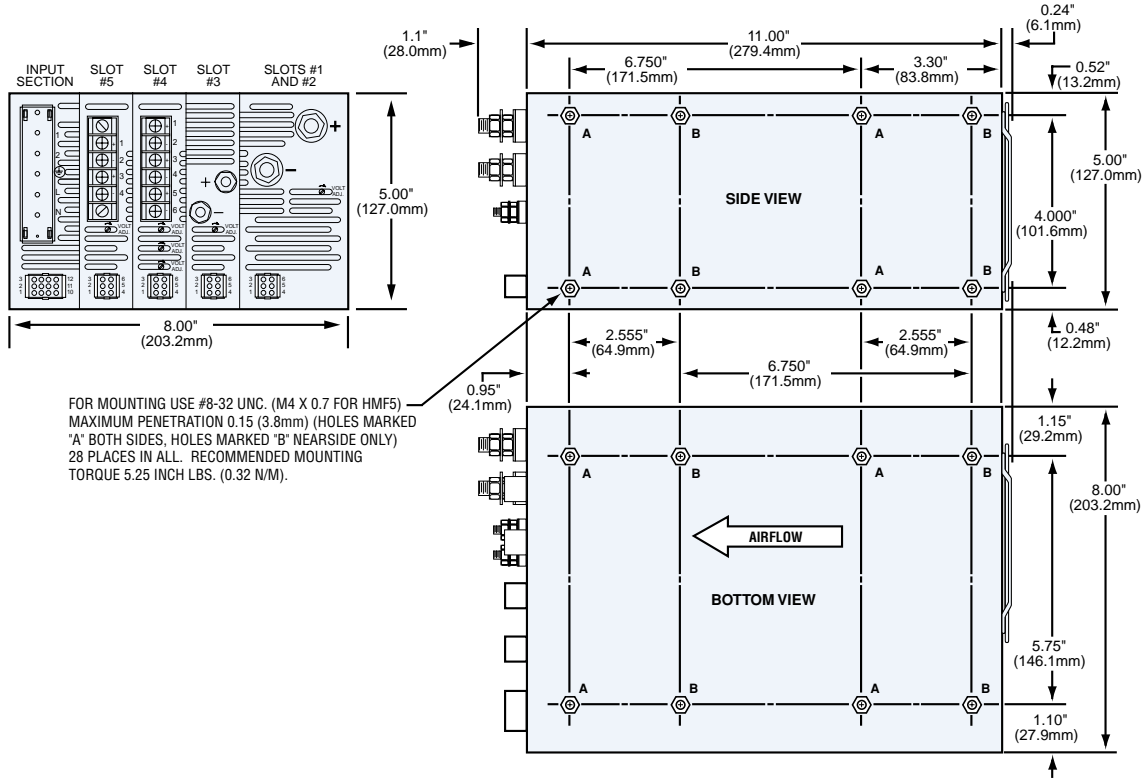

SPM5/HPM5 INPUT SECTION

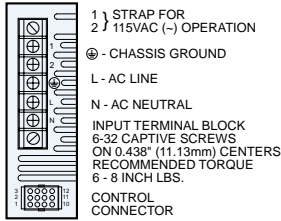

HPF5/HMF5 INPUT SECTION

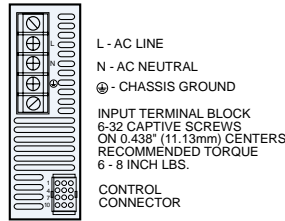

CONTROL FUNCTIONS

PIN	FUNCTION
5	POWER FAIL WARNING
6	OVER TEMP WARNING
7	5V @ 100mA*
10	SIGNAL GROUND
11	INHIBIT

MOLEX SERIES 1625-12 #03-06-1121
 MATING: 1625-12 #03-06-2122
 CONSULT FACTORY FOR OTHER AVAILABLE CONTROL FUNCTIONS
 * A lesser current is available if a logic option board is used. Consult factory.

OUTPUT MODULES—CONFIGURATIONS AND INTERFACE SIGNALS

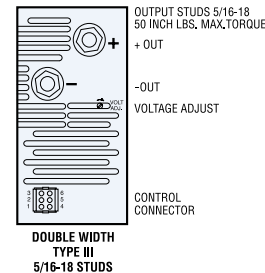
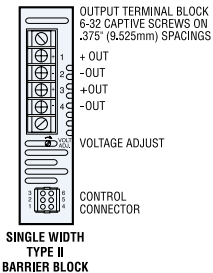
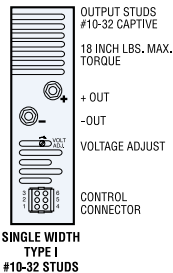

CONTROL FUNCTIONS

PIN	FUNCTION
1	+SENSE
2	MARGIN/REMOTE VOLTAGE ADJUST
3	OUTPUT GOOD SIGNAL
4	-SENSE & LOGIC GROUND
5	CURRENT SHARE CONTROL
6	INHIBIT

MOLEX SERIES 1625-6 #03-06-1061
 MATING: 1625-6 #03-06-2061
 CONSULT FACTORY FOR OTHER AVAILABLE CONTROL FUNCTIONS

*Metric mounting chassis meet all specifications of non-metric models.

HPM7 / HMM7*

OVERALL SIZE: 13.00" x 11.00" x 5.00" (330.2mm x 279.4mm x 127.0mm)
WEIGHT: 21.0 LBS (9.60 kg)

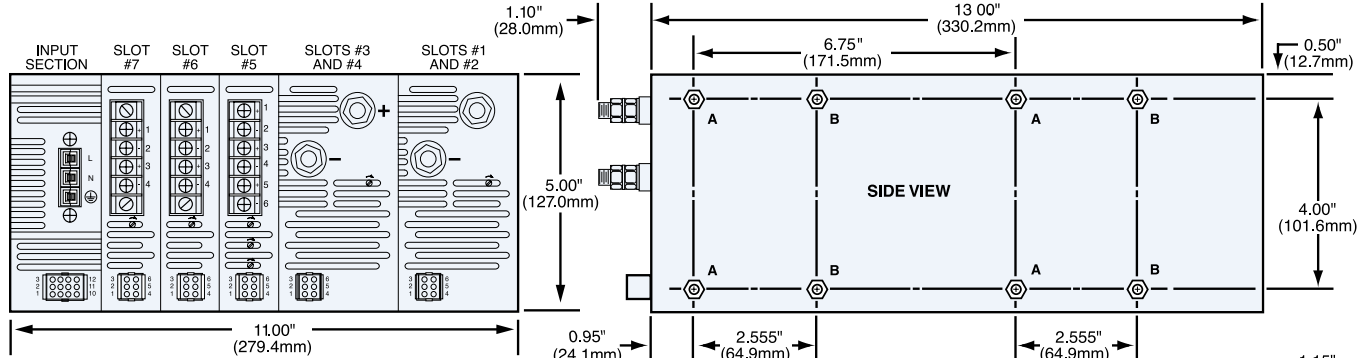

HPM7 INPUT SECTION

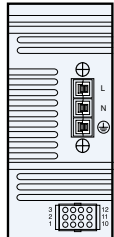

L - AC LINE
 N - AC NEUTRAL
 ⊕ - CHASSIS GROUND

CONTROL CONNECTOR

HPM7 MATING CONNECTOR INFORMATION:
 MANUFACTURER: AMP
 MATING HOUSING: 556137-3 (GREEN/GROUND)
 556137-6 (BLUE/AC NEUTRAL)
 556137-8 (GRAY/AC LINE)
 CONTACTS (3 REQ'D): 556136-2

FOR MOUNTING USE #8-32 UNC. MAXIMUM PENETRATION 0.15" (3.8mm) (HOLES MARKED "A" BOTH SIDES, HOLES MARKED "B" NEAR SIDE ONLY) TYPICAL.

CONTROL FUNCTIONS

PIN	FUNCTION
5	POWER FAIL WARNING
6	OVER TEMP WARNING
7	5V @ 100mA*
10	SIGNAL GROUND
11	INHIBIT

MOLEX SERIES 1625-12 #03-06-1121
 MATING: 1625-12 #03-06-2122
 CONSULT FACTORY FOR OTHER AVAILABLE CONTROL FUNCTIONS
 * A lesser current is available if a logic option board is used. Consult factory.

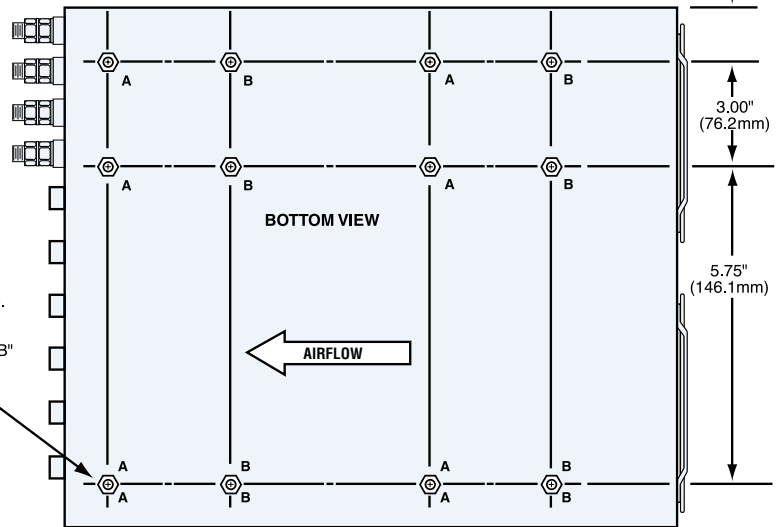

OUTPUT MODULES—CONFIGURATIONS AND INTERFACE SIGNALS

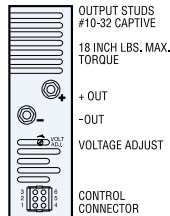

SINGLE WIDTH TYPE I #10-32 STUDS

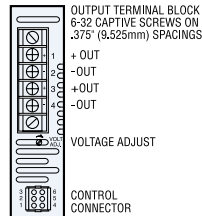

SINGLE WIDTH TYPE II BARRIER BLOCK

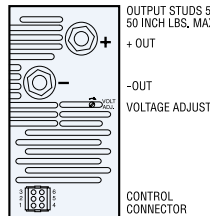

DOUBLE WIDTH TYPE III 5/16-18 STUDS

CONTROL FUNCTIONS

PIN	FUNCTION
1	+SENSE
2	MARGIN/REMOTE VOLTAGE ADJUST
3	OUTPUT GOOD SIGNAL
4	-SENSE & LOGIC GROUND
5	CURRENT SHARE CONTROL
6	INHIBIT

MOLEX SERIES 1625-6 #03-06-1061
 MATING: 1625-6 #03-06-2061
 CONSULT FACTORY FOR OTHER AVAILABLE CONTROL FUNCTIONS

*Metric mounting chassis meet all specifications of non-metric models.

RPM5 / RMM5*

OVERALL SIZE: 15.00" x 8.00" x 5.00" (381.0mm x 203.2mm x 127.0mm)

WEIGHT: 21.0 LBS (9.60 kg)

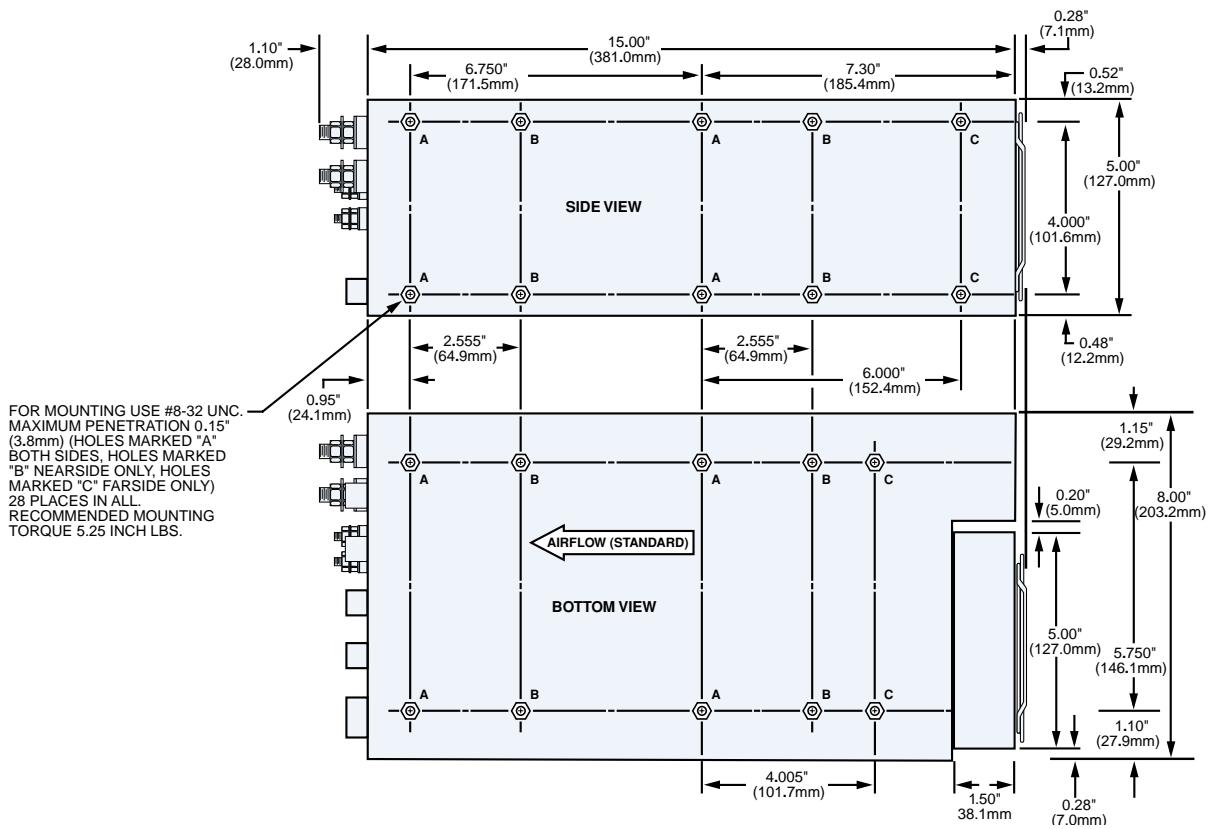
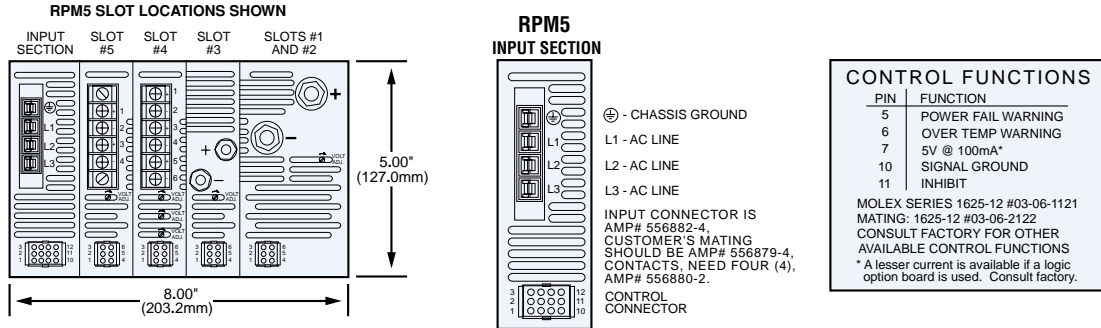

OUTPUT MODULES—CONFIGURATIONS AND INTERFACE SIGNALS

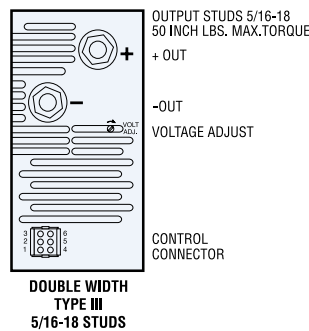
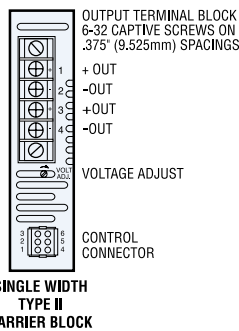
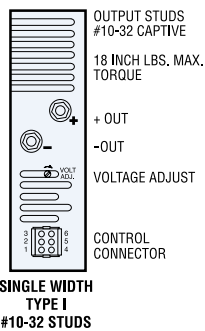

PIN	FUNCTION
1	+SENSE
2	MARGIN/REMOTE VOLTAGE ADJUST
3	OUTPUT GOOD SIGNAL
4	-SENSE & LOGIC GROUND
5	CURRENT SHARE CONTROL
6	INHIBIT

MOLEX SERIES 1625-6 #03-06-1061
MATING: 1625-6 #03-06-2061
CONSULT FACTORY FOR OTHER AVAILABLE CONTROL FUNCTIONS

*Metric mounting chassis meet all specifications of non-metric models.