

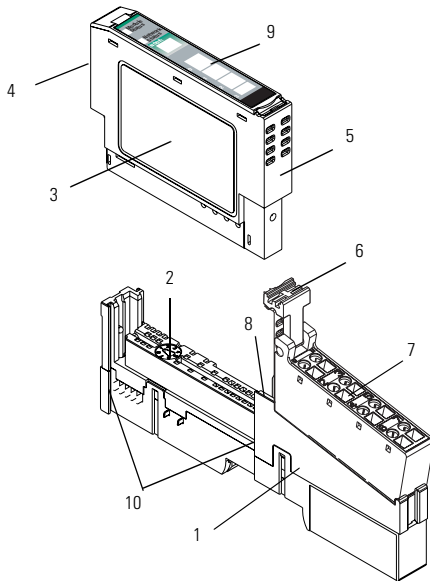

Installation Instructions

POINT I/O 2 or 4 Relay Output Module

(Cat. No. 1734-OW2 and 1734-OW4, Series C)



	Description		Description
1	Mounting Base ¹	6	RTB Removal Handle
2	Mechanical Keying (orange)	7	Removable Terminal Block (RTB) ¹
3	Module Wiring Diagram	8	DIN Rail Locking Screw (orange)
4	Module Locking Mechanism	9	Slide-in Writable Label
5	Insertable I/O Module	10	Interlocking Side Pieces

¹ Wiring Base Assembly consists of item 1) mounting base, 1734-MB and item 7) removable terminal block, 1734-RTB or -RTBS.

This Series C product can be used with DeviceNet and PROFIBUS adapters. It can be used with ControlNet and Ethernet adapters using RSLogix 5000, version 11 (or higher) software.

Important User Information

Solid state equipment has operational characteristics differing from those of electromechanical equipment. *Safety Guidelines for the Application, Installation and Maintenance of Solid State Controls* (Publication SGI-1.1 available from your local Rockwell Automation sales office or online at <http://www.ab.com/manuals/gi>) describes some important differences between solid state equipment and hard-wired electromechanical devices. Because of this difference, and also because of the wide variety of uses for solid state equipment, all persons responsible for applying this equipment must satisfy themselves that each intended application of this equipment is acceptable.

In no event will Rockwell Automation, Inc. be responsible or liable for indirect or consequential damages resulting from the use or application of this equipment.



The examples and diagrams in this manual are included solely for illustrative purposes. Because of the many variables and requirements associated with any particular installation, Rockwell Automation, Inc. cannot assume responsibility or liability for actual use based on the examples and diagrams.

No patent liability is assumed by Rockwell Automation, Inc. with respect to use of information, circuits, equipment, or software described in this manual.

Reproduction of the contents of this manual, in whole or in part, without written permission of Rockwell Automation, Inc. is prohibited.

Throughout this manual we use notes to make you aware of safety considerations.

Important User Information

WARNING 	Identifies information about practices or circumstances that can cause an explosion in a hazardous environment, which may lead to personal injury or death, property damage, or economic loss.
ATTENTION 	Identifies information about practices or circumstances that can lead to personal injury or death, property damage, or economic loss. Attentions help you: <ul style="list-style-type: none">• identify a hazard• avoid a hazard• recognize the consequence
IMPORTANT	Identifies information that is critical for successful application and understanding of the product.

ATTENTION



Environment and Enclosure

This equipment is intended for use in a Pollution Degree 2 industrial environment, in overvoltage Category II applications (as defined in IEC publication 60664-1), at altitudes up to 2000 meters without derating.

This equipment is considered Group 1, Class A industrial equipment according to IEC/CISPR Publication 11. Without appropriate precautions, there may be potential difficulties ensuring electromagnetic compatibility in other environments due to conducted as well as radiated disturbance.

This equipment is supplied as "open type" equipment. It must be mounted within an enclosure that is suitably designed for those specific environmental conditions that will be present and appropriately designed to prevent personal injury resulting from accessibility to live parts. The interior of the enclosure must be accessible only by the use of a tool. Subsequent sections of this publication may contain additional information regarding specific enclosure type ratings that are required to comply with certain product safety certifications.

See NEMA Standards publication 250 and IEC publication 60529, as applicable, for explanations of the degrees of protection provided by different types of enclosure. Also, see the appropriate sections in this publication, as well as the Allen-Bradley publication 1770-4.1 ("Industrial Automation Wiring and Grounding Guidelines"), for additional installation requirements pertaining to this equipment.

ATTENTION



POINT I/O is grounded through the DIN rail to chassis ground. Use zinc plated, yellow chromated steel DIN rail to assure proper grounding. Using other DIN rail materials (e.g. aluminum, plastic, etc.) which can corrode, oxidize or are poor conductors can result in improper or intermittent platform grounding.

WARNING**EXPLOSION HAZARD**

- Do not disconnect equipment unless power has been removed or the area is known to be nonhazardous.
 - Do not disconnect connections to this equipment unless power has been removed or the area is known to be nonhazardous. Secure any external connections that mate to this equipment by using screws, sliding latches, threaded connectors, or other means provided with this product.
 - Substitution of components may impair suitability for Class I, Division 2.
 - If this product contains batteries, they must only be changed in an area known to be nonhazardous.
-

ATTENTION**Preventing Electrostatic Discharge**

This equipment is sensitive to electrostatic discharge, which can cause internal damage and affect normal operation. Follow these guidelines when you handle this equipment:

- Touch a grounded object to discharge potential static.
 - Wear an approved grounding wriststrap.
 - Do not touch connectors or pins on component boards.
 - Do not touch circuit components inside the equipment.
 - If available, use a static-safe workstation.
 - When not in use, store the equipment in appropriate static-safe packaging.
-

Installing the Mounting Base

To install the mounting base on the DIN rail, proceed as follows.

1. Position the mounting base vertically above the installed units (adapter, power supply or existing module).
2. Slide the mounting base down allowing the interlocking side pieces to engage the adjacent module or adapter.
3. Press firmly to seat the mounting base on the DIN rail. The mounting base will snap into place.
4. To remove the mounting base from the DIN rail, remove the module, and use a small bladed screwdriver to rotate the base locking screw to a vertical position. This releases the locking mechanism. Then lift straight up to remove.

Installing the I/O Module

The module can be installed before, or after base installation. Make sure that the mounting base is correctly keyed before installing the module into the mounting base. In addition, make sure the mounting base locking screw is positioned horizontal referenced to the base.

WARNING



When you insert or remove the module while backplane power is on, an electrical arc can occur. This could cause an explosion in hazardous location installations. Be sure that power is removed or the area is nonhazardous before proceeding.

-
1. Using a bladed screwdriver, rotate the keyswitch (2) on the mounting base clockwise until the number 7 aligns with the notch in the base.
 2. Make certain the DIN rail locking screw is in the horizontal position. (You cannot insert the module if the locking mechanism is unlocked.)
 3. Insert the module straight down into the mounting base and press to secure. The module will lock into place.

Installing the Removable Terminal Block (RTB)

A removable terminal block is supplied with your wiring base assembly. To remove, pull up on the RTB handle. This allows the mounting base to be removed and replaced as necessary without removing any of the wiring. To reinsert the removable terminal block, proceed as follows.

1. Insert the end opposite the handle into the base unit. This end has a curved section that engages with the wiring base.
2. Rotate the terminal block into the wiring base until it locks itself in place.
3. If an I/O module is installed, snap the RTB handle into place on the module.

WARNING



When you connect or disconnect the Removable Terminal Block (RTB) with field side power applied, an electrical arc can occur. This could cause an explosion in hazardous location installations. Be sure that power is removed or the area is nonhazardous before proceeding.

Removing a Mounting Base

To remove a mounting base, you must remove any installed module, and the module installed in the base to the right. Remove the removable terminal block (if wired).

1. Unlatch the RTB handle on the I/O module.
2. Pull on the RTB handle to remove the removable terminal block.

WARNING



When you connect or disconnect the Removable Terminal Block (RTB) with field side power applied, an electrical arc can occur. This could cause an explosion in hazardous location installations. Be sure that power is removed or the area is nonhazardous before proceeding.

3. Press on the module lock on the top of the module.
 4. Pull on the I/O module to remove from the base.
-

WARNING



When you insert or remove the module while backplane power is on, an electrical arc can occur. This could cause an explosion in hazardous location installations. Be sure that power is removed or the area is nonhazardous before proceeding.

5. Repeat steps 1, 2, 3 and 4 for the module to the right.
6. Use a small bladed screwdriver to rotate the orange base locking screw to a vertical position. This releases the locking mechanism.
7. Then lift straight up to remove.

Communicating with Your Module

I/O messages are sent to (consumed) and received from (produced) the POINT I/O modules. These messages are mapped into the processor's memory. This POINT I/O output module does not produce input data (scanner Rx). It does consume 1 byte of I/O data (scanner Tx).

Default Data Map for the 1734-OW2 Input Module

Message size: 1 Byte

	7	6	5	4	3	2	1	0	
Consumes (scanner Tx)	Not used						Ch1	Ch0	Channel state
Where: 0 = Off, 1 = On									

Default Data Map for the 1734-OW4 Input Module

Message size: 1 Byte

	7	6	5	4	3	2	1	0	
Consumes (scanner Tx)	Not used				Ch3	Ch2	Ch1	Ch0	Channel state
Where: 0 = Off, 1 = On									

Wiring the Relay Output Module

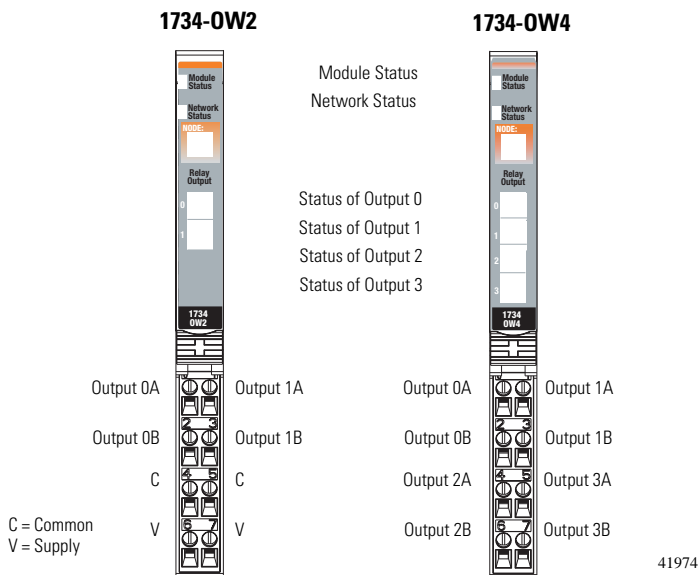

ATTENTION

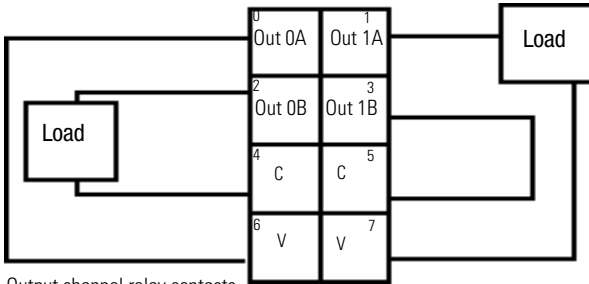

Relay contacts are not directly powered by the internal power bus. Load power from the internal power bus is available for the 1734-OW2 only. (Connect to pins 6 and 7 for V supply, and 4 and 5 for V common.) Load power must be provided by an external power source for the 1794-OW4. The 1734-OW4 module **cannot** be powered from the internal power bus.

1734-OW2**Load powered by Internal Power Bus**

Out = Output channel relay contacts
 V = Supply (can range from +5V dc to 240V ac)
 C = Common

42018

Channel	Output	Common	Supply
0A	0	4	6
0B	2	4	6
1A	1	5	7
1B	3	5	7

Supply voltage can range from +5V dc to 240V ac, depending on relay load.
 12/24V dc power for the module is provided by the internal power bus.

1734-0W2

Load powered by External Power

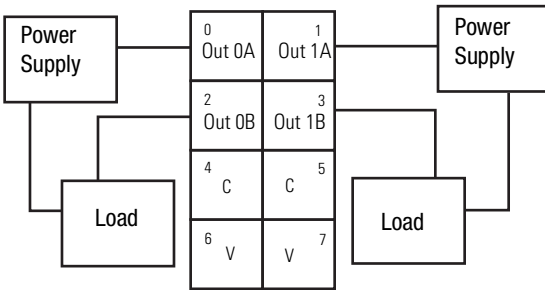

Out = Output channel relay contacts
 Power Supply = can range from +5V dc to 240V ac
 C = Common

Channel	Output	Common	Supply ¹
0A	0		
0B	2		
1A	1		
1B	3		

¹ Supply voltage can range from +5V dc to 240V ac, depending on relay load.
 12/24V dc power for the module is provided by the external power supply.

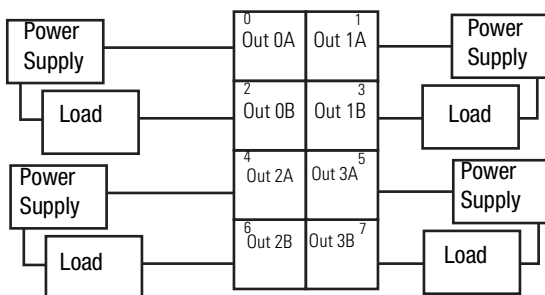
1734-OW4**Load powered by External Power**

Out = Output channel relay contacts

Channel	Output	Common	Supply ¹
0A	0		
0B	2		
1A	1		
1B	3		
2A	4		
2B	6		
3A	5		
3B	7		

¹ Supply voltage can range from +5V dc to 240V ac, depending on relay load.

12/24V dc power for the module is provided by the external power supply.

Note: The power supply voltage may be daisy-chained from a 1734 adapter, 1734-FPD or 1734-EP24DC communication interface. Each channel is individually isolated and may have a unique supply and/or voltage as necessary.

ATTENTION



- Do not attempt to increase load current or wattage capability beyond the maximum rating by connecting 2 or more outputs in parallel. The slightest variation in relay switching time may cause one relay to momentarily switch the total load current.
- Make certain that all relay wiring is properly connected before applying any power to the module.
- Total current draw through the wiring base unit is limited to 10A. Separate power connections to the terminal base unit may be necessary.
- Use the end cap from your adapter or interface module to cover the exposed interconnections on the last mounting base on the DIN rail. Failure to do so could result in equipment damage or injury from electric shock.

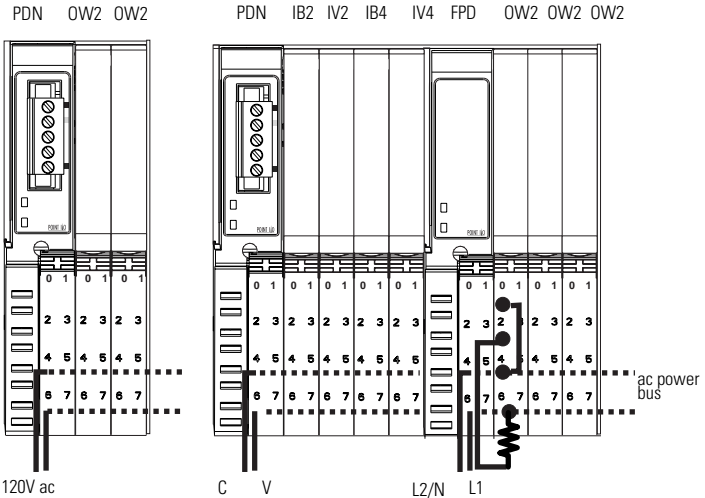

Wiring with ac Modules only

Wiring Using a 1734-FPD to Create a New ac Power Bus

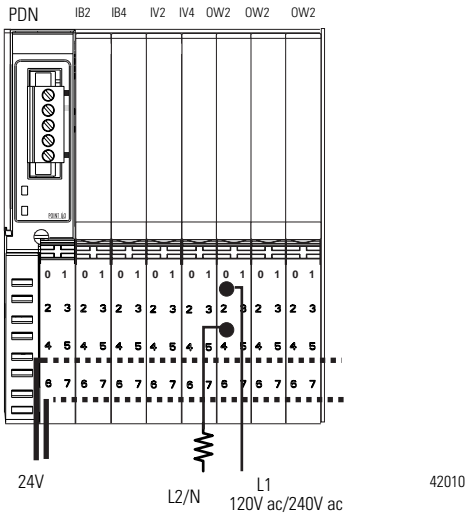

Wiring using external power source for ac Relay power

Troubleshooting with the Indicators

1734-OW2



Module Status
Network Status

Status of Output 0
Status of Output 1
Status of Output 2
Status of Output 3

1734-OW4

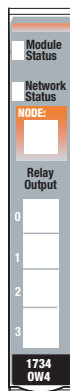

41974

Module Status

Off	No power applied to device
Green	Device operating normally
Flashing Green	Device needs commissioning due to configuration missing, incomplete or incorrect.
Flashing Red	Recoverable fault.
Red	Unrecoverable fault may require device replacement
Flashing Red/Green	Device is in self-test

Indicator	Indication	Probable Cause
-----------	------------	----------------

Network Status

Off	Device is not on-line - Device has not completed dup_MAC_id test. - Device not powered - check module status indicator
Flashing Green	Device is on-line but has no connections in the established state.



	Green	Device on-line and has connections in the established state.
	Flashing Red	One or more I/O connections in timed-out state
	Red	Critical link failure - failed communication device. Device detected error that prevents it communicating on the network.
	Flashing Red/Green	Communication faulted device - the device has detected a network access error and is in communication faulted state. Device has received and accepted an Identify Communication Faulted Request - long protocol message.

Indicator	Indication	Probable Cause
I/O Status		
	Off	Outputs off.
	Yellow	Outputs on.

Safety Approvals

North American Hazardous Location Approval

The following modules are North American Hazardous Location approved:
1734-OW2 and 1734-OW4.

The following information applies when operating this equipment in hazardous locations:	Informations sur l'utilisation de cet équipement en environnements dangereux:
<p>Products marked "CL I, DIV 2, GP A, B, C, D" are suitable for use in Class I Division 2 Groups A, B, C, D, Hazardous Locations and nonhazardous locations only. Each product is supplied with markings on the rating nameplate indicating the hazardous location temperature code. When combining products within a system, the most adverse temperature code (lowest "T" number) may be used to help determine the overall temperature code of the system. Combinations of equipment in your system are subject to investigation by the local Authority Having Jurisdiction at the time of installation.</p>	<p>Les produits marqués "CL I, DIV 2, GP A, B, C, D" ne conviennent qu'à une utilisation en environnements de Classe I Division 2 Groupes A, B, C, D dangereux et non dangereux. Chaque produit est livré avec des marquages sur sa plaque d'identification qui indiquent le code de température pour les environnements dangereux. Lorsque plusieurs produits sont combinés dans un système, le code de température le plus défavorable (code de température le plus faible) peut être utilisé pour déterminer le code de température global du système. Les combinaisons d'équipements dans le système sont sujettes à inspection par les autorités locales qualifiées au moment de l'installation.</p>
<div style="display: flex; align-items: center;"> <div style="border: 1px solid black; background-color: black; color: white; padding: 5px; margin-right: 10px;">WARNING</div> <div style="text-align: center;">  </div> </div> <p>EXPLOSION HAZARD -</p> <ul style="list-style-type: none"> • Do not disconnect equipment unless power has been removed or the area is known to be nonhazardous. • Do not disconnect connections to this equipment unless power has been removed or the area is known to be nonhazardous. Secure any external connections that mate to this equipment by using screws, sliding latches, threaded connectors, or other means provided with this product. • Substitution of components may impair suitability for Class I, Division 2. • If this product contains batteries, they must only be changed in an area known to be nonhazardous. 	<div style="display: flex; align-items: center;"> <div style="border: 1px solid black; background-color: black; color: white; padding: 5px; margin-right: 10px;">AVERTISSEMENT</div> <div style="text-align: center;">  </div> </div> <p>RISQUE D'EXPLOSION –</p> <ul style="list-style-type: none"> • Couper le courant ou s'assurer que l'environnement est classé non dangereux avant de débrancher l'équipement. • Couper le courant ou s'assurer que l'environnement est classé non dangereux avant de débrancher les connecteurs. Fixer tous les connecteurs externes reliés à cet équipement à l'aide de vis, loquets coulissants, connecteurs filetés ou autres moyens fournis avec ce produit. • La substitution de composants peut rendre cet équipement inadapté à une utilisation en environnement de Classe 1, Division 2. • S'assurer que l'environnement est classé non dangereux avant de changer les piles.

European Hazardous Location Approval

The following modules are European Zone 2 approved: 1734-OW2 and 1734-OW4.

European Zone 2 Certification (The following applies when the product bears the EEx Marking)

This equipment is intended for use in potentially explosive atmospheres as defined by European Union Directive 94/9/EC.

DEMKO certifies that this equipment has been found to comply with the Essential Health and Safety Requirements relating to the design and construction of Category 3 equipment intended for use in potentially explosive atmospheres, given in Annex II to this Directive. The examination and test results are recorded in EC-type-examination certificate DEMKO 04 ATEX 0330347 X.

Compliance with the Essential Health and Safety Requirements has been assured by compliance with EN 50021.

IMPORTANT

Observe the following additional Zone 2 certification requirements.

- This equipment is not resistant to sunlight or other sources of UV radiation.
 - The secondary of a current transformer shall not be open-circuited when applied in Class I, Zone 2 environments.
 - Equipment of lesser Enclosure Type Rating must be installed in an enclosure providing at least IP54 protection when applied in Class I, Zone 2 environments.
 - This equipment shall be used within its specified ratings defined by Allen-Bradley.
 - Provision shall be made to prevent the rated voltage from being exceeded by transient disturbances of more than 40% when applied in Class I, Zone 2 environments
-

Specifications

Specifications - 1734-OW2 and -OW4 Output Relay Module	
Outputs per Module	1734-OW2 - 2 Form A isolated (normally open) electromechanical relays 1734-OW4 - 4 Form A isolated (normally open) electromechanical relays
Off-State Leakage Current (max at 240V ac)	1.2mA and bleed resistor thru snubber circuit
Output Voltage Range (load dependent)	5-28.8V dc @ 2.0A resistive 48V dc @ 0.5A resistive 125V dc @ 0.25A resistive 125V ac @ 2.0A resistive 240V ac @ 2.0A resistive
Output Current Rating (at rated power)	Resistive 2A @ 5-28.8V dc 0.5A @ 48V dc 0.25A @ 125V dc 2A @ 125V ac 2A @ 240V ac Inductive 2.0A steady state @ 5-28.8V dc, L/R = 7ms 0.5A steady state @ 48V dc, L/R = 7ms 0.25A steady state @ 125V dc, L/R = 7ms 2.0A steady state, 15A make @ 125V ac, PF = cos θ = 0.4 2.0A steady state, 15A make @ 240V ac, PF = cos θ = 0.4
Power Rating (steady state)	250W max. for 125V ac resistive output 480W max. for 240V ac resistive output 60W max. for 28.8V dc resistive output 24W max. for 48V dc resistive output 31W max. for 125V dc resistive output 250VA max. for 125V ac inductive output 480VA max. for 240V ac inductive output 60VA max. for 28.8V dc inductive output 24VA max. for 48V dc inductive output 31VA max. for 125V dc inductive output
Output Signal Delay OFF to ON	10ms maximum (time from valid output on signal to relay energization by module)
ON to OFF	26ms maximum (time from valid output off signal to relay deenergization by module)
Initial Contact Resistance	30m Ω
Switching Frequency	1 operation/3s (0.3Hz at rated load) max
Operate/Release Time	10ms max
Bounce Time	1.2ms (mean)
Minimum Contact Load	100 μ A at 100mV dc

Expected Life of Electrical Contacts	Minimum 100,000 operations @ rated loads
Fusing	Module outputs are not fused. If fusing is desired, you must supply external fusing.
Indicators	1 green/red network status indicator, logic side 1 green/red module status indicator, logic side 1734-OW2 - 2 yellow output status indicators 1734-OW4 - 4 yellow output status indicators
Keyswitch position	7
General Specifications	
Module Location	1734-TB or -TBS wiring base assembly
Pointbus Current	80mA max @ 5V dc
Power Dissipation	0.5W max
Thermal Dissipation	1.7 BTU/hr max
Isolation Voltage Between any 2 sets of contacts	Tested to withstand 2550V dc for 60s
Customer load to logic	Tested to withstand 2550V dc for 60s
Field Power Bus Supply Voltage Voltage Range Supply Current	None required 240V ac max 1734-OW2 - 2A per channel maximum, 4A per module 1734-OW4 - 2A per channel maximum, 8A per module
Dimensions Inches (Millimeters)	2.21H x 0.47W x 2.97L (56H x 12W x 75.5L)
Environmental Conditions	
Operational Temperature	IEC 60068-2-1 (Test Ad, Operating Cold), IEC 60068-2-2 (Test Bd, Operating Dry Heat), IEC 60068-2-14 (Test Nb, Operating Thermal Shock): -20 to 55°C (-4 to 131°F)
Storage Temperature	IEC 60068-2-1 (Test Ab, Unpackaged Nonoperating Cold), IEC 60068-2-2 (Test Bb, Unpackaged Nonoperating Dry Heat), IEC 60068-2-14 (Test Na, Unpackaged Nonoperating Thermal Shock): -40 to 85°C (-40 to 185°F)
Relative Humidity	IEC 60068-2-30 (Test Db, Unpackaged Nonoperating Damp Heat): 5 to 95% noncondensing
Shock Operating Non-operating	IEC 60068-2-27 (Test Ea, Unpackaged Shock) 30g peak acceleration 50g peak acceleration
Vibration	IEC 60068-2-6, (Test Fc, Operating) Tested 5g @ 10-500Hz
ESD Immunity	IEC 61000-4-2: 6kV contact discharges 8kV air discharges

22 POINT I/O 2 or 4 Relay Output Module

Radiated RF Immunity	IEC 61000-4-3: 10V/m with 200Hz 50% Pulse 100%AM at 1890Mhz 10V/m with 200Hz 50% Pulse 100%AM at 900Mhz 10V/m with 1kHz sine-wave 80%AM from 30MHz to 2000MHz	
EFT/B Immunity	IEC 61000-4-4: ±4kV at 2.5kHz on signal ports ±4kV at 2.5kHz on power ports	
Surge Transient Immunity	IEC 61000-4-5: ±1kV line-line(DM) and ±2kV line-earth(CM) on power and signal ports	
Conducted RF Immunity	IEC 61000-4-6: 10Vrms with 1kHz sine-wave 80%AM from 150kHz to 80MHz	
Emissions	CISPR 11 Group 1, Class A	
Enclosure Type Rating	None (open-style)	
Conductors Wire Size	14 AWG (2.5mm ²) - 22 AWG (0.25mm ²) solid or stranded copper wire rated at 75°C or greater	
Category	3/64 inch (1.2mm) insulation maximum 2 ¹	
Terminal Base Screw Torque	7 pound-inches (0.8Nm)	
Field Wiring Terminations - 1734-OW2	0 - Output 0A 2 - Output 0B 4 - Common 6 - Supply	1 - Output 1A 3 - Output 1B 5 - Common 7 - Supply
Field Wiring Terminations - 1734-OW4	0 - Output 0A 2 - Output 0B 4 - Output 2A 6 - Output 2B	1 - Output 1A 3 - Output 1B 5 - Output 3A 7 - Output 3B
Mass	1734-OW2 - 1.30 oz/36.9 grams 1734-OW4 - 1.64 oz/46.5 grams	

Certifications (when product is marked)

C-UL-US - UL Listed Industrial Control Equipment, certified for US and Canada
C-UL-US - UL Listed for Class I, Division 2, Groups A, B, C and D Hazardous locations, certified for US and Canada
EEx² European Union 94/9/EEC ATEX Directive, compliant with:
 EN 50021; Potentially Explosive Atmospheres, Protection "n" (Zone 2) when used at or below 60V ac or 75V dc.
CE² European Union 89/336/EEC EMC Directive, compliant with:
 EN 61000-6-4; Industrial Emissions
 EN 50082-2; Industrial Immunity
 EN 61326; Meas./Control/Lab., Industrial Requirements
 EN 61000-6-2; Industrial Immunity
 European Union 73/23/EEC LVD Directive, compliant with:
 EN 61131-2; Programmable Controllers
C-Tick² Australian Radiocommunications Act compliant with AS/NZS CISPR 11, Industrial Emissions

- 1 Use this conductor category information for planning conductor routing as described in publication 1770-4.1, "Industrial Automation Wiring and Grounding Guidelines."
- 2 See the Product Certification link at www.ab.com for Declaration of Conformity, Certificates, and other certification details.

www.rockwellautomation.com

Power, Control and Information Solutions Headquarters

Americas: Rockwell Automation, 1201 South Second Street, Milwaukee, WI 53204-2496 USA, Tel: (1) 414.382.2000, Fax: (1) 414.382.4444

Europe/Middle East/Africa: Rockwell Automation, Vorstlaan/Boulevard du Souverain 36, 1170 Brussels, Belgium, Tel: (32) 2 663 0600, Fax: (32) 2 663 0640

Asia Pacific: Rockwell Automation, Level 14, Core F, Cyberport 3, 100 Cyberport Road, Hong Kong, Tel: (852) 2887 4788, Fax: (852) 2508 1846

Publication 1734-IN055D-EN-P - April 2004

PN 957859-42

Supersedes Publication 1734-IN055C-EN-P - April 2002

© 2004 Rockwell International Corporation. Printed in USA