

Design Features & Performance



CONSTRUCTION – Completely fabricated from non-corrosive materials, its bronze housing and high quality stainless steel shaft completely protect against external damage to the switch from salt spray or other corrosive elements. Sealing against leakage is achieved through the use of high quality gaskets on machined surfaces and “O” Ring protection, plus close tolerance between the shaft and bushing.

DURABILITY – All internal components are of high grade stainless steel or copper alloy (chrome plated when required), to protect against bearing surface wear and to provide millions of operations. Both the EA780 and EA790 series switches have heavy duty electrical contacts. The EA780 switches have sliding, double break type contacts built to meet the high shock requirements outlined in MIL-S-901. EA790 switches have heavy duty, double break butt type contacts.

CONTACTS – The EA780 switches are available in two contact arrangements 1 N.O. - 1 N.C. & 2 N.O. - 2 N.C.

The Standard B1 cam provides for clockwise or counter-clockwise operations; B2 cam for operation in both directions (clockwise & counter-clockwise) or Maintained is also available. Contacts wipe clean with each operation. The EA790 switch is available in two contact arrangements, 1 N.O. - 1 N.C. & 2 N.O. - 2 N.C. with B1, B2, Neutral, Maintained & Short Travel Cam Operations.

LEVERS – A variety of corrosion resistant levers are available to meet specific actuating requirements.

NOTE: Levers must be ordered as separate items. Please see “EL” series operating lever brochure.

Dimensions and Mounting

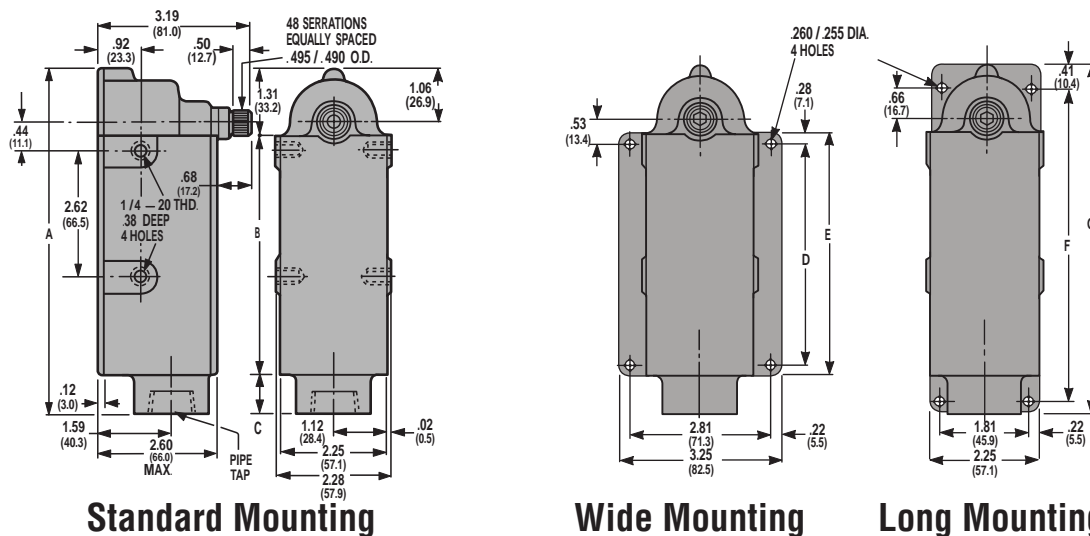

All dimensions given in US & Metric: Inches (mm)

CONTACT SEQUENCE	STANDARD SWITCH				MOUNTING STYLE			
	PIPE TAP SIZE	A	B	C	WIDE		LONG	
					D	E	F	G
1 N.O.-1 N.C.	1/2" - 14 NPT	4.94	3.00	.62	2.44	3.00	4.22	4.84
2 N.O.-2 N.C.	1-11 1/2 NPT	7.06	4.94	.81	4.38	4.94	6.41	7.06

Specifications

1. Conforms to MIL-C-2212F.
2. Enclosure meets NEMA Type 1, 4, 4X, 6, 6P and 13.
3. Watertight (3 ft. for 60 minutes) and submersible (15 ft. for 30 minutes) per MIL-STD-108E.
4. Meets vibration requirements of MIL-STD-167B, type I.
5. Meets Hi Shock requirements of MIL-S-901, Grade A, Class I, type A.
6. Contacts made of silver alloy. Contact shifting mechanism is locked in position by the latches until switch lever is actuated.
7. TEMPERATURE RANGE: -20°C to +90°C. Modifications available for temperatures to +150°C and -40°C continuous.
8. Operating lever is adjustable by 7°30' increments thru 360°.
9. Operating Torques -- Trip Torque varies from 6 to 33 in. lbs. depending on switch size and cam selected.
10. Current Ratings:

Switch Series

Voltage	EA790	EA780
125V-A.C.	20.0 Amps*	10.0 Amps*
250V-A.C.	15.0 Amps*	7.5 Amps*
480V-A.C.	10.0 Amps*	5.0 Amps*
600V-A.C.	5.0 Amps*	2.5 Amps*
125V-D.C.	5.0 Amps*	2.5 Amps*
250V-D.C.	1.5 Amps*	.75 Amps*

*75-100% Power Factor

11. Form Z Contact.

Ordering Information

EA780-Sliding Contacts

CONTACT CONFIGURATION	CAM & OPERATION	MOUNTING		
		STANDARD	WIDE	LONG
1 N.O. 1 N.C.	B-1 CW	EA780-10000	EA780-40000	EA780-70000
	B-1 CCW	EA780-10001	EA780-40001	EA780-70001
	B-2 CW & CCW	EA780-10100	EA780-40100	EA780-70100
2 N.O. 2 N.C.	B-1 CW	EA780-20000	EA780-50000	EA780-80000
	B-1 CCW	EA780-20001	EA780-50001	EA780-80001
	B-2 CW & CCW	EA780-20100	EA780-50100	EA780-80100
1 N.O./1 N.C.	MAINTAINED*	EA780-16000	EA780-46000	EA780-76000
2 N.O./2 N.C.	M CAM	EA780-26000	EA780-56000	EA780-86000

1 N.O./1 N.C.	MAINTAINED*	EA780-16700	EA780-46700	EA780-76700
2 N.O./2 N.C.	M-7 CAM	EA780-26700	EA780-56700	EA780-86700

**Series EA780
Sliding Type**

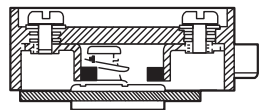

**Series EA790
Butt Type**

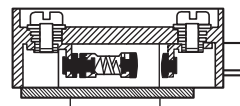

EA-790-Butt Contacts

CONTACT CONFIGURATION	CAM & OPERATION	MOUNTING		
		STANDARD	WIDE	LONG
1 N.O.* 1 N.C.	B-1 CW	EA790-10000	EA790-40000	EA790-70000
	B-1 CCW	EA790-10001	EA790-40001	EA790-70001
	B-2 CW & CCW	EA790-10100	EA790-40100	EA790-70100
2 N.O.* 2 N.C.	B-1 CW	EA790-20000	EA790-50000	EA790-80000
	B-1 CCW	EA790-20001	EA790-50001	EA790-80001
	B-2 CW & CCW	EA790-20100	EA790-50100	EA790-80100
1 N.O./1 N.C.	MAINTAINED**	EA790-16000	EA790-46000	EA790-76000
2 N.O./2 N.C.	M CAM	EA790-26000	EA790-56000	EA790-86000
1 N.O./1 N.C.	MAINTAINED**	EA790-16700	EA790-46700	EA790-76700
2 N.O./2 N.C.	M-7 CAM	EA790-26700	EA790-56700	EA790-86700
1 N.O./1 N.C.	SHORT TRAVEL B-9 CAM CW & CCW	EA790-10900	EA790-40900	EA790-70900
2 N.O./2 N.C.		EA790-20900	EA790-50900	EA790-80900
2 N.O.	NEUTRAL	EA790-15700	EA790-54700	EA790-75700
4 N.O.	N-1 CAM	EA790-25102	EA790-55102	EA790-85102
2 N.C.	NEUTRAL	EA790-15800	EA790-45800	EA790-75800
4 N.C.	N-1 CAM	EA790-25104	EA790-55104	EA790-85104

*During High Shock: N.C. contacts opened for more than 20 ms.
N.O. contacts did not close.

**Contacts may transfer during High Shock.

Operational Data

B1 CAM

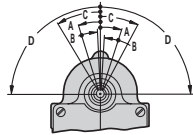

A. Trip Travel.....	18'
B. Reset Travel.....	14'
C. Recommended Travel.....	30'
D. Maximum Travel Available.....	90'
Torque (Inch Lbs.)	
1 N.O. - 1 N.C.	15
2 N.O. - 2 N.C.	27

B2 CAM

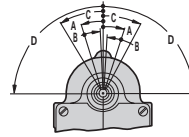

A. Trip Travel.....	18'
B. Reset Travel.....	14'
C. Recommended Travel.....	30'
D. Maximum Travel Available.....	90'
Torque (Inch Lbs.)	
1 N.O. - 1 N.C.	15
2 N.O. - 2 N.C.	27

Short Travel B9 CAM

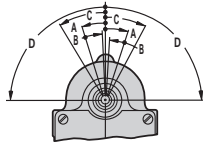

A. Trip Travel.....	13
B. Reset Travel.....	10
C. Recommended Travel.....	30
D. Maximum Travel Available.....	90
Torque (Inch Lbs.)	
1 N.O. - 1 N.C.	15
2 N.O. - 2 N.C.	27

Neutral N-1 CAM

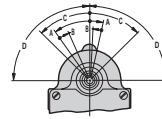

	Direction of Rotation	CW	CCW
A. Trip Travel.....	18°	31°	
B. Reset Travel.....	14°	22°	
C. Recommended Travel.....	30°	45°	
D. Total Travel.....	90°	90°	
	Torque	(inch Lbs.)	
N1 CAM	2 N.O.	CW	15
	2 N.O.	CCW	19.5
	4 N.O.	CW	16.5
	4 N.O.	CCW	16.5
N1 CAM	2 N.C.	CW	15
	2 N.C.	CCW	15
	4 N.C.	CW	16.5
	4 N.C.	CCW	16.5

Maintained M-CAM

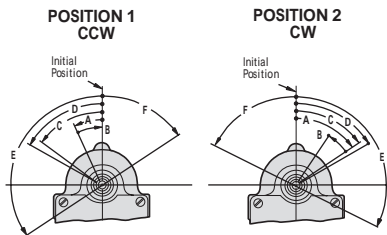

Position	1(CCW)	2(CW)	
A. Trip Travel	25°	55°	
B. Reset Travel	25°	22°	
C. Min. Travel to Maintain	54°	55°	
D. Recommended Travel	60°	60°	
E. Maximum Travel Available.....	124°	116°	
F. Overall Travel	56°	64°	
	Torque	(inch Lbs.)	
M CAM	1 N.O.	CW	6
	1 N.C.	CCW	9
	2 N.O.	CW	6
	2 N.C.	CCW	9

To change Switch Operation from Cam Position 1 to Position 2,

Maintained M7-CAM

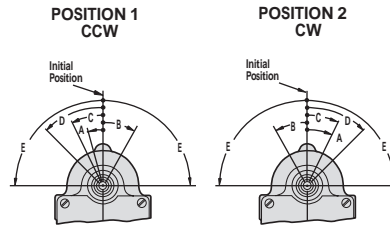

Position	1(CCW)	2(CW)	
A. Trip Travel	16°	30°	
B. Reset Travel	30°	26°	
C. Min. Travel to Maintain	26°	30°	
D. Recommended Travel	45°	45°	
E. Maximum Travel Available.....	90°	90°	
	Torque	(inch Lbs.)	
M7 CAM	1 N.O.	CW	12
	1 N.C.	CCW	13.5
	2 N.O.	CW	15
	2 N.C.	CCW	16.5

To change Switch Operation from Cam Position 1 to Position 2, Operate Switch thru Angle C. Remove Lever and Reset at Initial Position.

Typical Cams

B1 Single Action

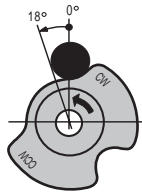

Normally open to make (normally closed to break) IN ONE DIRECTION ONLY. Lever and cam are spring returned to starting position. Used on Single Action Switches only.

B2 Double Action

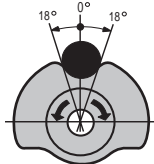

Normally open to make (normally closed to break) IN EITHER DIRECTION. Lever and cam are spring returned to starting position.

Combination B1/B2 CAM

The following three operating sequences are built into the combination cam used in the standard EA780/EA790 switches: B1 Single Action CW, B1 Single Action CCW and B2 Double Action CW & CCW.

1. The contacts function when the lever is operated clockwise. The lever can be operated counterclockwise but the contacts will not operate.
2. The contacts function when the lever is operated counterclockwise. The lever can be operated clockwise but the contacts will not operate.
3. The contacts function when the lever is operated clockwise or counterclockwise.