

# V5 Miniature switches



The V5 series of switches is a range of miniature switches designed to meet world wide specifications. The V5 series offers a very high electrical capacity, up to 22 Amps, 250 Vac, and the capability to withstand high in-rush currents. It has a long mechanical and electrical life, and the miniature thermoplastic housing can meet requirements to KC 250 or 150 °C. Resistance to arcing/tracking and temperature/humidity tolerances are very high. The complete range offers a large variety of contact types, actuators, terminations, operating characteristics and electrical ratings.

## High current capacity precision switches for long life and high reliability

The Honeywell V5 series is designed to meet the stringent requirements of today's designs for high currents, long operating life, precision and reliability. The internal mechanism is the key.

The two piece spring and carrier design provides a parallel path for higher current carrying capacity and better conduction of heat away from the contacts.

Because the "C" spring and the carrier move independently without flexing or hinging as in other designs, a much greater electrical and mechanical lifetime is achieved.

In addition, the V5 overcomes the problem of contact welding in applications using inductive, capacitive, lamp loads or high in-rush currents. With the V5, the large contact wiping action ensures that slight welds are broken off by the shearing movement when switching. This friction contact system also helps clean contacts during operation in applications where dust or other contaminants may be present. It helps reduce contact resistance and ensures maximum contact reliability whether switching milliamps or high currents.

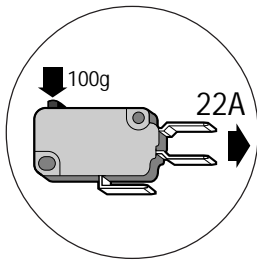

High current rating with low operating force (100 g [1 N], 22 A)

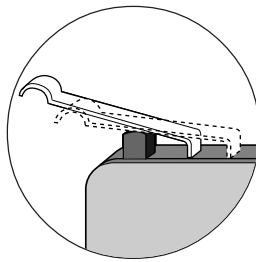

Wide range of operating levers: 2 mounting positions Only one operating point

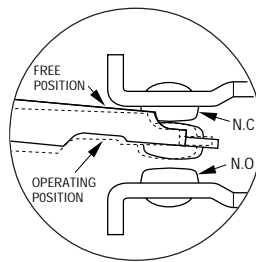

Contact wiping action - shearing action of contacts during switching ensures reliability

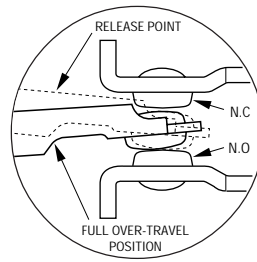

High grade, flame retardant thermoplastics

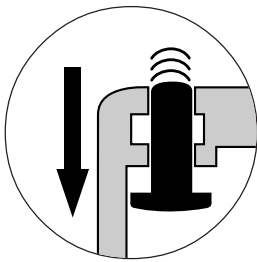

Safe operating - high overtravel

C spring  
Carrier

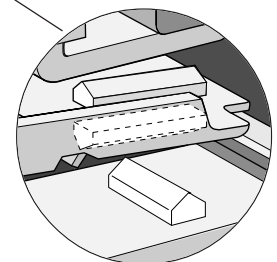
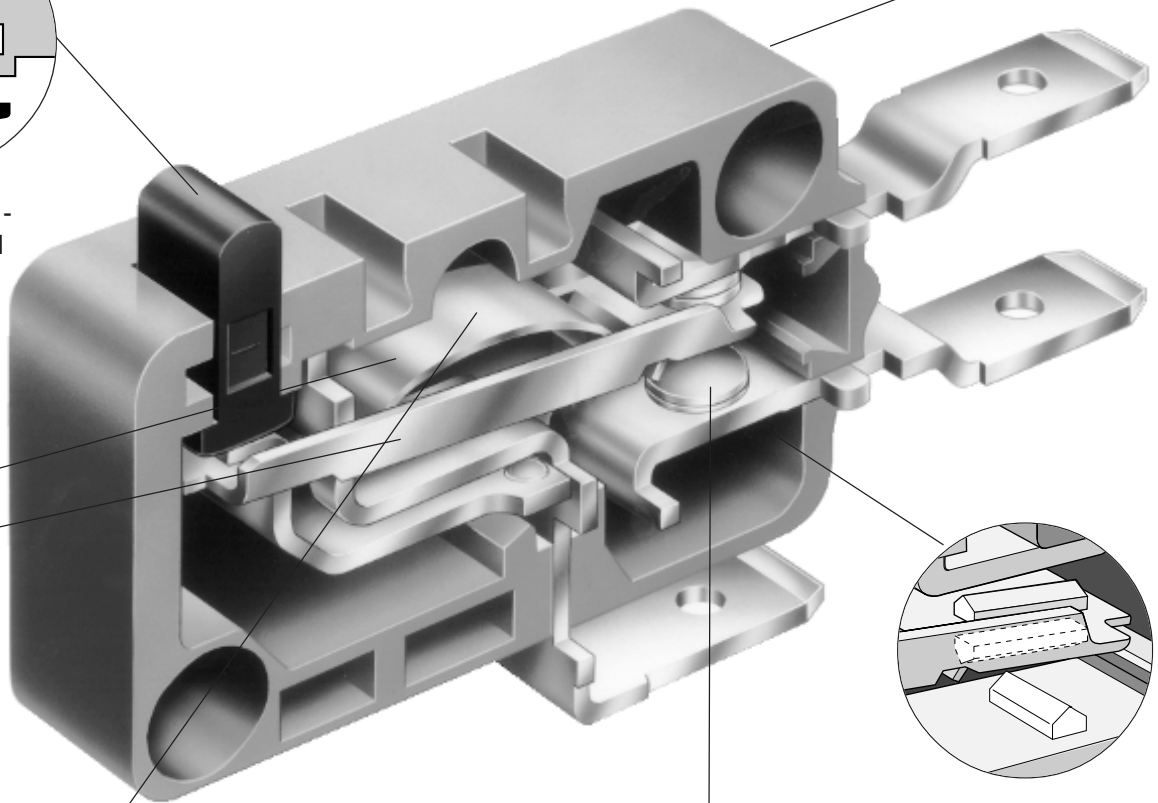

Gold cross point contacts available for excellent performance in low energy circuits

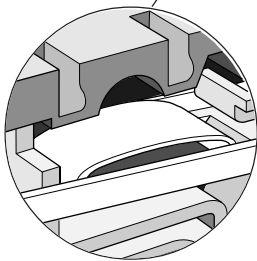

Two-piece spring and carrier mechanism gives extra long electrical and mechanical life.

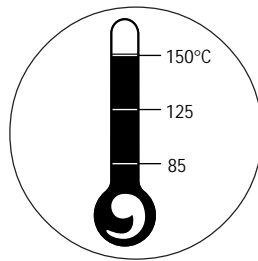

Wide range of operating temperature versions 85 °C, 125 °C, 150 °C

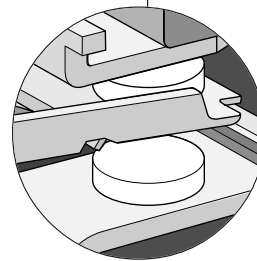

High contact reliability - optimum reliability due to high contact force

## Customised solutions to fit your exact needs

Usually, Honeywell can offer an “off the shelf” product to meet your requirements. But we also specialise in the supply of customised versions to your own specification. Contact us for more information.

### Technical data

#### Materials

##### Case / Cover:

Thermoplastic

85 °C Glass filled polyester

125 °C Glass filled nylon

150 °C Glass filled polyetherimide

##### All materials flame retardant:

UL94VO rated

##### Actuator:

Teflon filled phenolic for smooth operation

##### Terminals: NO and NC Terminals

Brass (CuZn); Ag plated on solder types and 16 amp and 20 amp versions

##### Common terminal:

Brass (CuZn), Ag plated

##### Contact materials:

Gold alloy cross point 90 Au 10 Ag

Fine Silver Ag

Silver cadmium oxide AgCdO

##### Auxiliary actuator:

Plain - stainless steel

Roller - stainless steel with phosphor bronze roller

##### Operating temperature:

85 °C, 125 °C, 150 °C

##### Minimum operating temperature:

-55 °C

#### Approvals:

Worldwide standards approvals - BEAB, VDE, SEMKO, UL, CSA and others

#### Tracking resistance:

85 °C version rated to >KC 175

125 °C version rated to >KC 250

#### Contact gap:

<3 mm (u)

#### Mechanical life (full overtravel):

30,000,000

#### Electrical life (at full rated load):

100,000 operations (min)

## The Honeywell V5 selection guide

A catalogue listing number is built up using the table below. First, choose the appropriate code for the electrical rating and operating characteristics required from the first column of the table eg. V5 A is for 20(4) Amp switch with 1.6 mm pretravel, 300 g operating force and 75 g release force. Then select the remaining code letters from the other columns as desired, subject to their availability for the rating and characteristics chosen, as indicated by the "•" symbol.

#### Example:

**V 5 A 0 1 0 C B 1 D**

This is a 20(4) A switch with 85 °C max. temperature rating, SPDT contact arrangement, silver cadmium oxide contacts, 6.3x0.8 mm silver plated straight terminals, and short roller lever mounted in the slot furthest from plunger. It would be marked with full European approvals.

#### Note:

When ordering a V5 switch without lever, do not specify a 10th character. Only specify the 9th character if a UL/CSA approved switch without lever is required.

P.T. max mm	1.6	1.6	3.2	1.6	3.2	6.4	3.2	1.6	9
D.T. max mm	0.25	0.25	0.75	0.25	0.75	1.5	0.75	0.25	1.9
O.T. min mm	0.8	0.8	1.2	0.8	1.2	2.4	1.2	0.8	3.3
O.P. min	14.7±0.3	15.3±0.3	15.3±0.9	20.6±0.5	20.6±1.0	15.3±1.8	18.5±0.9	20.6±0.5	15.3±2.4

\* ratios apply when the lever is fitted in slot position 1 characteristics are measured at the end of the lever

PT = Pretravel (mm max.)      OT = Overtravel (mm min.)      OF = Operating force (g max.)  
 DT = Differential travel (mm max.)      OP = Operating point (+0.5 mm)      RF = Release Force (g min.)

### Electrical rating and operating force (Pin Plunger)

(Amp)	g max	V5 Series
22, 250 Vac	300	N
22, 250 Vac	100	S
20(4), 250 Vac	300	A
16(4), 250 Vac	500	T
16(4), 250 Vac	400	U
16(4), 250 Vac	300	B
16(3), 250 Vac	200	P
16(3), 250 Vac	100	R
10(3), 250 Vac	200	C
10(3), 250 Vac	100	D
10(3), 250 Vac	50	F
5(2.5), 250 Vac	50	G
5(2.5), 250 Vac	25	H
0.1 A, 30 Vdc, 125 Vac	200	J
0.1 A, 30 Vdc, 125 Vac	100	K
0.1 A, 30 Vdc, 125 Vac	50	L

22 Amp versions approved to BEAB BS3955 only

### Max temperatures

85	125	150
0	1	2
.		
.		
.		
.	.	
.	.	
.	.	.
.	.	.
.	.	.
.	.	.
.	.	.
.	.	.
.	.	.
.	.	.
.	.	.

### Contact arrangement

SPDT*	SPNC*	SPNO*
1	2	3
.	.	.
.	.	.
.	.	.
.	.	.
.	.	.
.	.	.
.	.	.
.	.	.
.	.	.
.	.	.
.	.	.
.	.	.
.	.	.
.	.	.
.	.	.

\*SPDT = single pole double throw  
 \*SPNC = single pole normally closed  
 \*SPNO = single pole normally open

### Contact materials

Silver Cad Oxide or Silver	Silver	Gold Alloy
0	1	2
.		
.		
.		
.		
.		
.		
.		
.		
.		
.		
.		
.	.	
.	.	
.	.	
.	.	.
.	.	.

**V 5**

### Lever (actuator) mounting position

1	Slot position 1, European approvals
2	Slot position 2, European approvals
3	Slot position 1, or without lever, UL, CSA and European approvals
4	Slot position 2, UL, CSA and European approvals

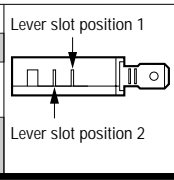

### Terminal angle \*

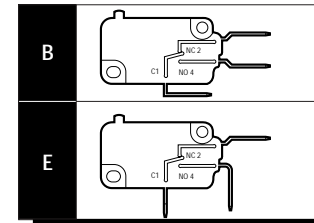

\* Other terminal angles are available. Contact your local Honeywell sales office for more information.

### Terminal types

V5 SERIES	6.3 x 0.8mm	6.3 x 0.8mm	6.3 x 0.8mm	4.8 x 0.8mm	4.8 x 0.5mm	4.8 x 0.5mm	4.8 x 0.8mm	short solder	standard solder
	O.C.	O.C. Ag plate	O.C.	O.C.	O.C.	O.C. Ag plate	O.C. Ag plate		
	B	C	D	E	F	P	S	T	
N	.								
S	.								
A	.								
T	.	.					.	.	
U	.	.					.	.	
B	.	.					.	.	
P	.					1	.	.	
R	.	.				1	.	.	
C	.	.	.	.			.	.	
D	.	.	.	.			.	.	
F	.	.					.	.	
G	.	.	.	.			.	.	
H	.	.	.	.			.	.	
J	.	.	.	.			.	.	
K	.	.	.	.			.	.	
L	.	.	.	.			.	.	

### Lever actuator

Pin Plunger (no lever)	1:1 * straight		2:1 straight		1:1 roller		2:1 roller		4:1 straight		2:1 simul. roller		1:1 simul. roller		5.5:1 straight		
	OF	RF	OF	RF	OF	RF	OF	RF	OF	RF	OF	RF	OF	RF	OF	RF	
	B		C		D		E		G		H		L		N		
300	75	300	75	180	30	350	60	180	30	90	15	180	30	350	60	70	10
100	25	100	25	60	10	120	20	60	10	30	5	60	10	120	20	25	3.5
300	75	300	75	180	30	350	60	180	30	90	15	180	30	350	60	70	10
500	125	500	125	300	50	600	100	300	50	150	25	300	50	600	100	120	18
400	100	400	100	240	40	480	80	240	40	120	20	240	40	480	80	100	14
300	75	300	75	180	30	350	60	180	30	90	15	180	30	350	60	70	10
200	50	200	50	120	20	240	40	120	20	60	10	120	20	240	40	47	7
100	25	100	25	60	10	120	20	60	10	30	5	60	10	120	20	25	3.5
200	50	200	50	120	20	240	40	120	20	60	10	120	20	240	40	47	7
100	25	100	25	60	10	120	20	60	10	30	5	60	10	120	20	25	3.5
50	12	50	12	30	5	60	10	30	5	15	2.5	30	5	60	10	15	1.5
50	12	50	12	30	5	60	10	30	5	15	2.5	30	5	60	10	15	1.5
25	6	25	6	15	2.5	30	5	15	2.5	7.5	1.5	15	2.5	30	5	-	-
200	50	200	50	120	20	240	40	120	20	60	10	120	20	240	40	47	7
100	25	100	25	60	10	120	20	60	10	30	5	60	10	120	20	25	3.5
50	12	50	12	30	5	60	10	30	5	15	2.5	30	5	60	10	15	1.5

\*Q.C. = Quick Connect • = available 1 = available 125 C version only

# V5 technical information

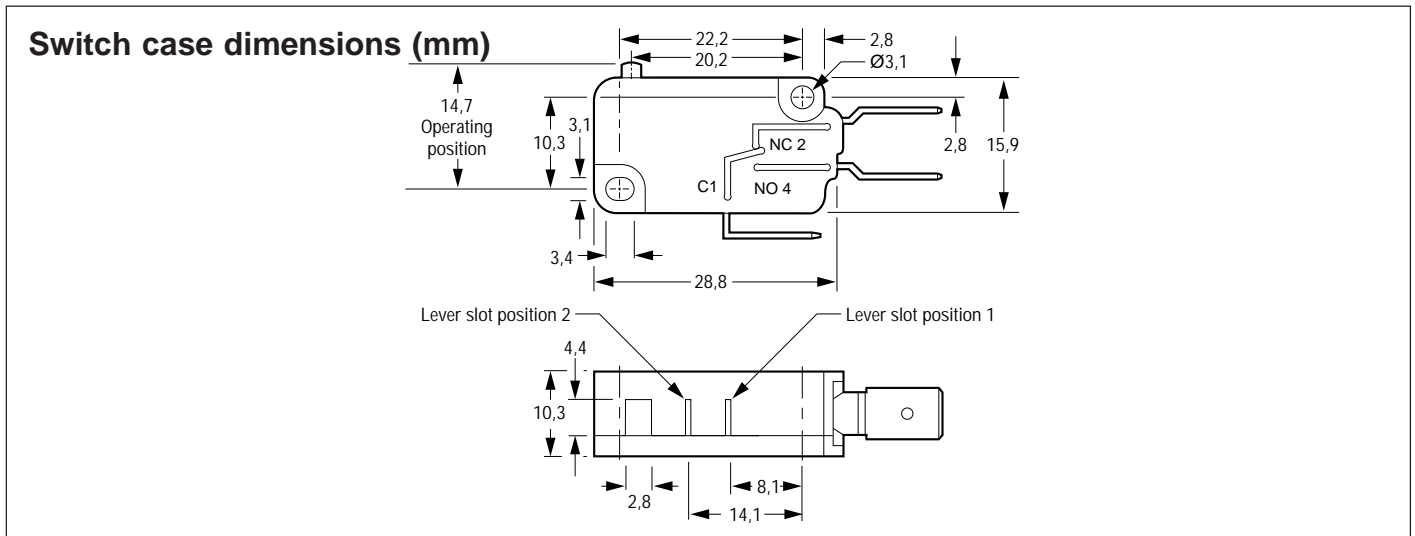

Terminal dimensions (mm)	7th digit of part number
	<p><b>B, C</b> (6,3 x 0,8)</p>
	<p><b>E, F</b> (4,8 x 0,5)</p> <p><b>D, P</b> (4,8 x 0,8)</p>
	<p><b>S</b> (short solder)</p>
	<p><b>T</b> (standard solder)</p>

# Lever actuator dimensions (mm)

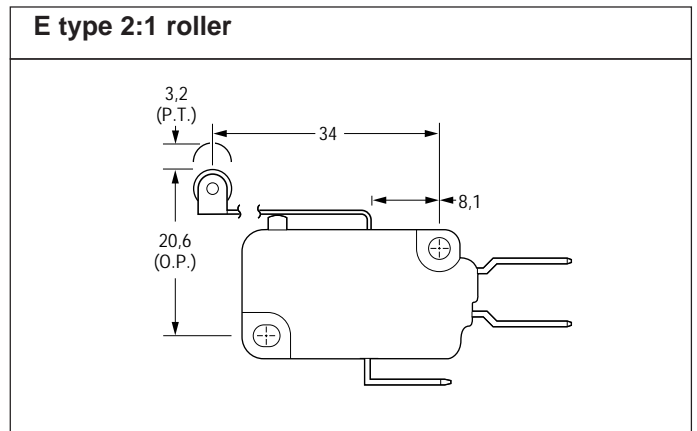
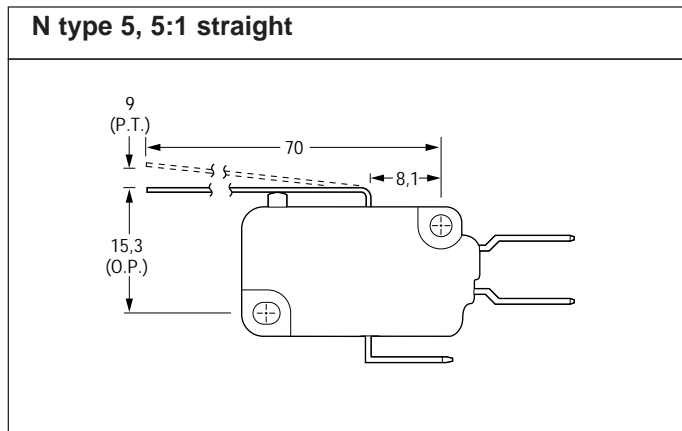
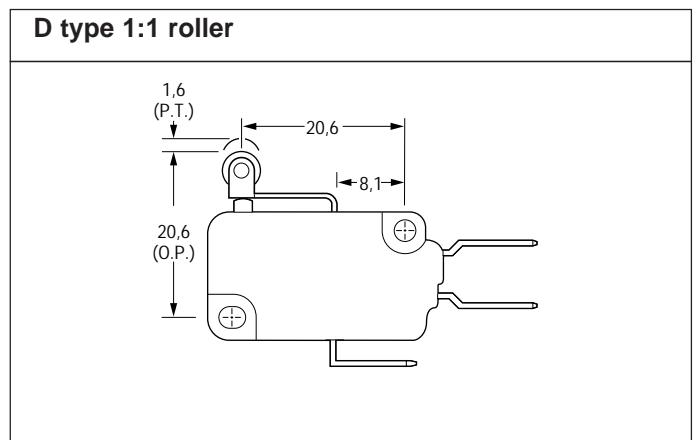
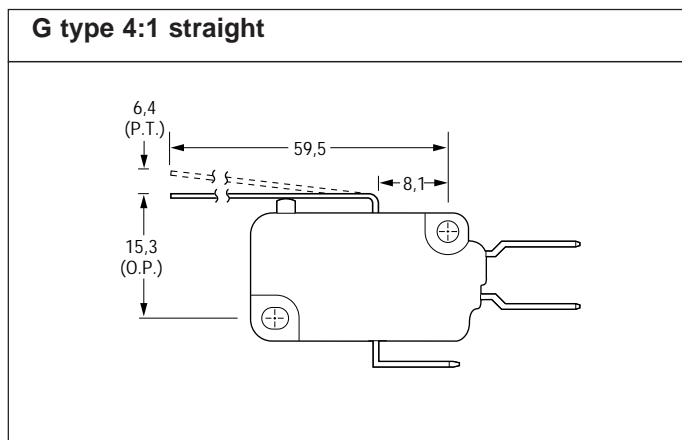
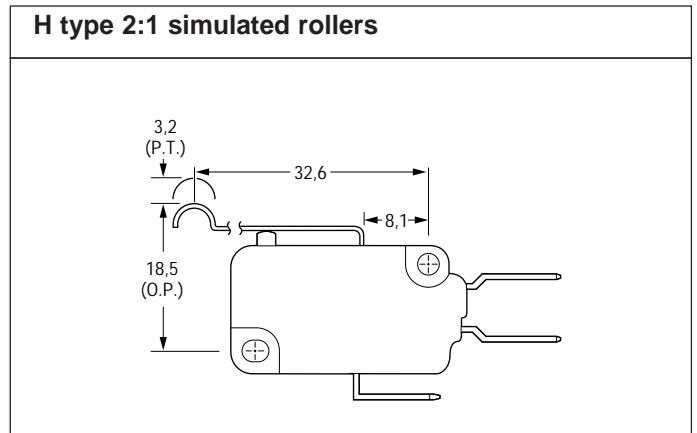
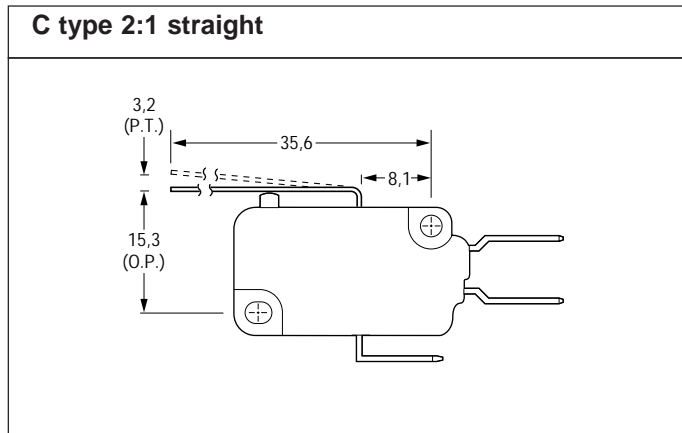
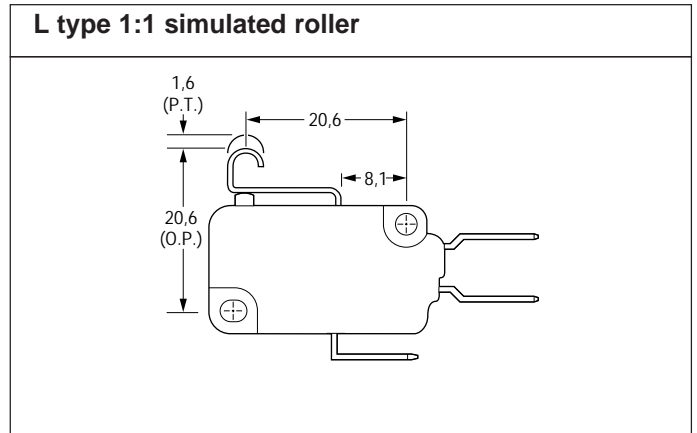
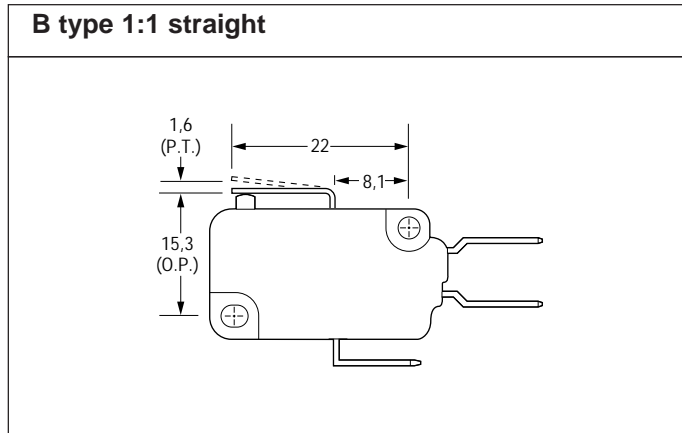

Ratio applies when the lever is fitted in slot position 1