

**AR-B1682---SOCKET 370 PENTIUM III GRADE
CPU CARD WITH VGA/LCD/LAN/SCSI**

Operation Manual

Version 1.3

COPYRIGHT NOTICE

This operation manual is expected to assist both Embedded Computer manufacturers and users in installing and setting up the system. The information contained in this document is subject to change without any notice.

Copyright Acrosser Technology Co., Ltd, 2000. All rights are reserved. No part of this publication can be reproduced, transmitted, transcribed, stored in a retrieval system, or translated into any language or computer language, in any form or any means, electronic, mechanical, magnetic, optical, chemical, manual or otherwise, without the prior written consent of Acrosser Technology.

ACKNOWLEDGEMENTS

All other trademarks and registered trademarks mentioned herein are the property of their respective owners.

1. INTRODUCTION.....	1
1-1. ABOUT THIS MANUAL	2
1-2. SYSTEM SPECIFICATION.....	3
1-3. SAFETY PRECAUTIONS.....	4
2. HARDWARE CONFIGURATION	5
2-1. JUMPER & CONNECTOR QUICK REFERENCE TABLE	6
2-2. COMPONENT LOCATIONS	7
2-3. HOW TO SET JUMPERS	7
2-4. SYSTEM CLOCK SELECT AND CPU SETTING	8
2-5. RS232/485 SELECTION	8
2-6. DOC MEMORY	8
2-7. COM1 CONNECTOR(CN24).....	10
2-8. COM2 CONNECTOR(CN12).....	10
2-9. PS2 KB(CN25).....	10
2-10. EXTERNAL KEYBOARD & MOUSE CONNECTOR(CN23)	11
2-11. RESET SWITCH(CN18)	11
2-12. HDD LED Header(CN16)	11
2-13. POWER LED & KEYLOCK CONNECTOR(CN13).....	11
2-14. IR CONNECTOR(CN5).....	11
2-15. FLOPPY DISK DRIVE CONNECTOR(CN6)	12
2-16. HARD DISK DRIVE CONNECTOR.....	12
2-17. LCD CONNECTOR 24BIT(CN9)	14
2-18. LCD CONNECTOR 36BIT(CN9+CN11).....	14
2-19. EXTERNAL SPEAKER HEADER(CN20)	16
2-20. Ethernet RJ-45 Connector(CN21)	16
2-21. VGA CRT CONNECTOR(CN19)	16
2-22. WATCHDOG CONNECTOR(CN17)	16
2-23. PRINTER CONNECTOR(CN2).....	17
2-24. SYSTEM FAN POWER CONNECTOR(CN27)	17
2-25. POWER ON CONNECTOR FOR ATX POWER SUPPLY(CN15).....	17
2-26. POWER CONTROL CONNECTOR(CN4).....	17
2-27. SCSI CONNECTOR(CN3).....	18
2-28. UNIVERSAL SERIAL BUS CONNECTOR (CN14)	18
2-29. CPU FAN POWER CONNECTOR(CN26).....	18
2-30. CLEAR CMOS FUNCTION(J4).....	19
2-31. DOC SOCKET(U21).....	19
2-32. Touch Screen CONNECTOR(CN10)	19
2-33. MEMORY INSTALLING	20
3. SOFTWARE UTILITIES.....	21
3-1. Utility Disk File.....	22
3-2. SETUP	22
3-3. WATCHDOG TIMER CONFIGURATION	23
4. AMI BIOS SETUP	27
4-1. BIOS SETUP OVERVIEW.....	29
4-2. STANDARD CMOS SETUP	30
4-3. ADVANCED CMOS SETUP.....	31
4-4. ADVANCED CHIPSET SETUP	34

4-5. POWER MANAGEMENT	36
4-6. PCI/PLUG AND PLAY	38
4-7. PERIPHERAL SETUP	40
4-8. AUTO-DETECT HARD DISKS	41
4-9. PASSWORD SETTING	41
4-10. Setting the Password	41
4-11. Password Checking	41
4-12. LOAD DEFAULT SETTING	41
4-13. BIOS EXIT	42
4-14. BIOS UPDATE	42
APPENDIX A	44
A-1. ISA BUS PIN ASSIGNMENT	45
A-2. PICMG BUS PIN ASSIGNMENT	46
APPENDIX B	48
B-1. INTERRUPT MAP	49
B-2. RTC & CMOS RAM MAP	50
B-3. TIMER & DMA CHANNELS MAP	51
B-4. I/O & MEMORY MAP	52
APPENDIX C	54
TROUBLE SHOOTING	54

1. INTRODUCTION

This chapter describes:

- About This Manual
- System Specifications
- Safety precautions
- Experienced users can skip to chapter 2 on page 5 for Quick Start.

1-1. ABOUT THIS MANUAL

Thank you for purchasing our AR-B1682---Socket 370 Pentium III Grade CPU Card with VGA / LCD / LAN / SCSI, fully PC / AT compatible. This manual contains five chapters. By following the instructions herein, you can easily use AR-B1682 CPU board.

Chapter 1 Introduction

This chapter notifies you how to avoid the damages against this CPU Card as well as describes the background of this manual and the specification of AR-B1682..

Chapter 2 Hardware Configuration

This chapter outlines the components' locations and their functions. From this part, you can find how to set jumper and configure this card, as you need.

Chapter 3 Software Utilities

Helpful information about the proper installations of the VGA , LAN and the Watchdog-timer function are provided in this chapter.

Chapter 4 AMI BIOS Setup

This chapter indicates you how to set up the BIOS configurations.

Appendix A Expansion Bus

This section introduces you the expansion bus for ISA BUS and PICMG .

Appendix B Technical Summary

This section gives you the information about the Technical maps.

Appendix C Trouble Shooting

This section outlines the errors might occur and some solutions are suggested.

1-2. SYSTEM SPECIFICATION

CPU:

Supports 333~650MHz Socket 370 Celeron / Coppermine Pentium III grade CPU

CHIPSET:

INTEL 440BX

RAM MEMORY :

Supports 3 168-pin DIMM(PC-100 SDRAM)sockets, 768Mb max.

CACHE SIZE:

Internal 128KB L2 cache inside the CPU.

ETHERNET:

Use RT8139C chipset, support 10/100M Base T with RJ-45 connector built-in LED.

SCSI:

Use SYMBIOS53C895 or equivalent, supports Ultra-Wide SCSI II with 80MB transfer rate. With one 2.54mm 68-pin SCSI connector.

SUPER I/O:

2 PCI IDE---with one 2.54 mm 40-pin connectors, and one 2.0mm 44pin connector.

1 FDC---with 2.54mm 34 -pin connector.

1 Parallel--- with 2.54 mm 26-pin connector. Supports SPP/EPP/ECP mode.

1 RS-232C-COM port 1 with DB9 connector located at bracket.

1 RS-232C/RS-485/IrDA/Touch Screen -COM port 2.

RS-232C/RS485 is selected by jumper and use the same connector.

IrDA use 2.54mm 5-pin header.

Touch Screen uses 2.0mm 3-pin JST connector.

BIOS:

AMI flash BIOS (256KB, including VGA/LCD/LAN BIOS) Supports utility program for easy to update new version of BIOS.

KEYBOARD/MOUSE:

PS/2 compatible with 2.0mm 6-pin JST connector and 6-pin mini-DIN connector located at bracket.

BUS INTERFACE:

PICMG -ISA

VGA/LCD DISPLAY:

C&T 69000 with 2MB VRAM internally. (Dual display BIOS supported)

CRT-with HDB 15-pin connector located at bracket.

LCD-with 2.0mm 44-pin connector. (Mono/DSTN/TFT)

TV-Out-with RCA terminal.

WATCHDOG :

Built-In Supper I/O W83977 Chipset.

SYSTEM POWER REQUIREMENT:

+5V-5.0A max. & +12V-1.0A max. (Based on 500 MHz CPU).

USB:

Built-in 2 ports USB interface with 2.54mm 10-pin headers.

RTC:

Chipset including, Supports ACPI Function with 10 years data retention.

SPEAKER:

Supports on-board buzzer and external speaker. (with 2.5mm 4-pin header).

FLASH DISK:

Supports 1 DiskOnChip Socket 144MB.

H/W MONITORING:

Built-in (Winbond WB83783) hardware monitoring chipset.

HEADERS:

2-pin Reset, hard disk LED, and power/watchdog LED.

3-pin CPU cooling fan and Chassis cooling fan.

SWITCHES:

Use SMD DIP switch to select base clock and CPU clock multiplier.

BUS DRIVER CAP:

High driver for 32 TTL level loads (max.)

CPU SP:

Separated Vcore and Vio.

CE DESIGN-IN:

Add EMI components to COM ports, Parallel port, CRT, USB, Keyboard, and PS/2 mouse.

PC BOARD:

6 layers, EMI considered, especially in switching power layout.

BOARD DIMENSION:

Compact size 338.6mm x 121.9mm(13.33" x 4.80")

1-3. SAFETY PRECAUTIONS

Follow the messages hereinafter to protect your systems from damage on all occasions.

Touch a grounded metal object to discharge the static electricity in your body (or ideally, wear a grounded wrist strap)

Stay safe from the electric shock. Don't touch any components of this card when the card is on. Always switch off power when the system is not in use.

Disconnect power when changing any hardware devices. For instance, when you connect a jumper or install any cards, a surge of power may damage the electronic components or the whole system.

2. HARDWARE CONFIGURATION

Four parts are included:

- Jumper & Connector Quick Reference Table
- Components' Locations
- Configuration and Jumper settings
- Connector Pin Assignments

2-1. JUMPER & CONNECTOR QUICK REFERENCE TABLE

SWITCH & JUMPER:

DOC 2000 SEG	SW1
CPU f Ratio Selecting.....	SW2
System Clock Select.....	SW3
RS232/485 Selection	J1, J2, J3
DOC Memory Mapping	JP6, JP7
Clear CMOS Function.....	JP4

CONNECTOR:

COM1 Connector	CN24
COM2 Connector	CN12
PS/2 Connector	CN25
External PS/2 Connector	CN23
Reset Switch	CN18
Floppy Disk Drive Connector	CN6
Hard Disk Drive Connector	CN1, CN7
Hard Disk Drive LED Connector	CN16
Power LED & KeyLock Connector	CN13
LCD Panel Connector	CN9, CN11
Ethernet RJ-45 Connector	CN21
External Speaker Connector	CN20
Printer Connector	CN2
System Fan Power Connector	CN27
SCSI Connector	CN3
CPU Fan Power Connector	CN26
VGA Connector	CN19
IR Connector	CN5
Touch Screen Connector	CN10
Power on connector for ATX Supply	CN15
Power Control Connector	CN4
Power LED&Key Lock	CN13
External Keyboard & Mouse Connector	CN23
Watchdog LED Connector	CN17
Universal Serial Bus Connector	CN4
Memory Installing	DIMM1, DIMM2, DIMM3
Disk-On-Chip Socket	U21

2-2. COMPONENT LOCATIONS

AR-B1682 Connector, Jumper and Component Locations

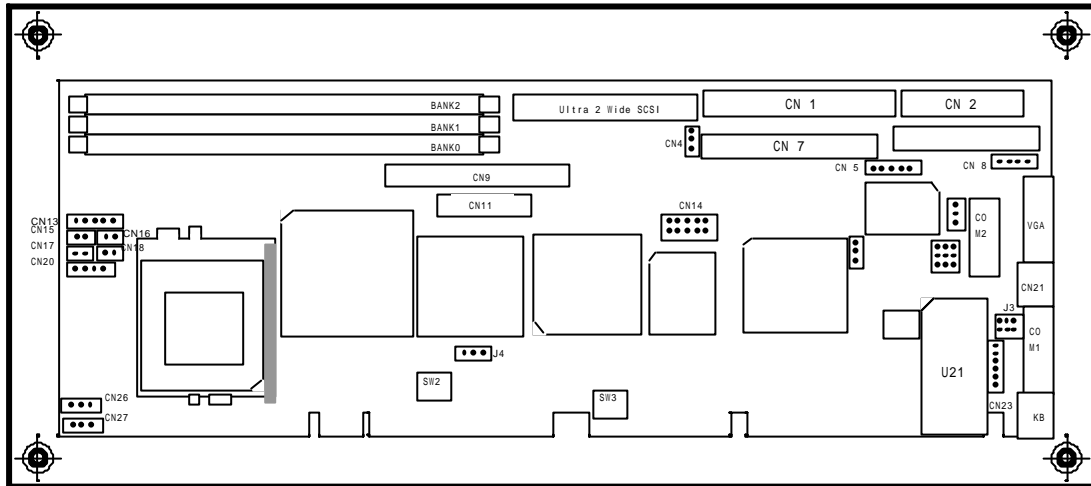

2-3. HOW TO SET JUMPERS

A jumper consists of two or three metal pins with a plastic base mounted on the card, and a small plastic cap (with a metal contact inside) to connect the pins, so you can set up your hardware configuration by "open" or close the pins. The jumper can be combined into sets which called jumper blocks. When the jumpers are all in the block, you have to put them together to set up the hardware configuration. The figure below shows how it looks.



JUMPERS AND CAP

If a jumper has three pins, for example, labelled PIN1, PIN2, and PIN3, you can either connect PIN1 & PIN2 to create one setting and shorting or connect PIN2 & PIN3 to create another setting. The jumper setting rules are applied throughout this manual.

2-4. SYSTEM CLOCK SELECT AND CPU SETTING

System clock and CPU frequency ratio are automatically detected by BIOS. Please keep sw2 , sw3-1 , sw3-2 ,and sw3-3 off.

2-5. RS232/485 SELECTION

The jumper settings are as follows:

(1)COM 1 & COM2 (RS232)

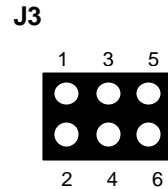
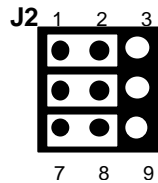
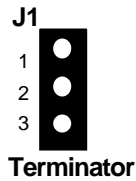

(2)COM 2(RS485)

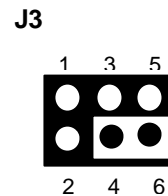
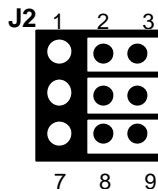
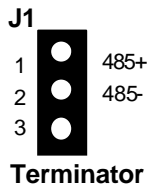

2-6. DOC MEMORY

(1) DOC Memory Mapping Selection (JP6, JP7)

A 32-pin DOC socket supports a DOC (Disk-on-Chip) up to 72Mb. This PnP Flash ROM DOC can be installed as one of the user's hard disk drive. And if set as Drive C, it can be used to boot up the computer with MS-DOS installed. It offers much faster access than a floppy or hard disk and greatly increases reliability under harsh environment.

The DOC Memory Mapping is as follows:

DOC Memory Map	JUMPER SETTING (pin closed) JP6 JP7	JUMPER ILLUSTRATION
----------------	---	------------------------

Manufactory default --- CC000h-CDFFFh

(2) DOC 2000 SEG (SW1)

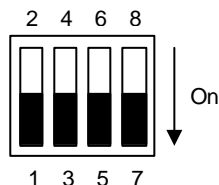

SEG	3-4	5-6	7-8
CC00H	ON	ON	OFF
D000H	ON	OFF	ON
D400H	ON	OFF	OFF
D800H	OFF	ON	ON

DC00H	OFF	ON	OFF
E000H	OFF	OFF	ON
DISABLE	OFF	OFF	OFF

2-7. COM1 CONNECTOR(CN24)

COM1 : COM1 Connector, DB9 male connector

The COM1 Connector assignments are as follows:

PIN	ASSIGNMENT
1	DCD
2	RX
3	TX
4	DTR
5	GND
6	DSR
7	RTS
8	CTS
9	RI

2-8. COM2 CONNECTOR(CN12)

COM2 : COM2 Connector

The COM2 Connector assignments are as follows :

PIN	ASSIGNMENT		
	RS-232	RS-422	RS-485
1	DCD	TX-	DATA-
2	RX	TX+	DATA+
3	TX	RX+	NC
4	DTR	RX-	NC
5	GND	GND	GND
6	DSR	RTS-	NC
7	RTS	RTS+	NC
8	CTS	CTS+	NC
9	RI	CTS-	NC
10	NC	NC	NC

2-9. PS2 KB(CN25)

DIN : PS2 Connector

The PS2 connector can support Keyboard & Mouse.

The pin assignments for PS2 Connector are as follows :

PIN	ASSIGNMENT
1	KBDATA
2	MSDATA
3	GND
4	Vcc
5	KBCLK
6	MSCLK

2-10. EXTERNAL KEYBOARD & MOUSE CONNECTOR(CN23)

EXPS2 : External PS2 Connector

The pin assignments are as follows:

PIN	ASSIGNMENT
1	KBDATA
2	MSDATA
3	GND
4	Vcc
5	KBCLK
6	MSCLK

2-11. RESET SWITCH(CN18)



2-12. HDD LED Header(CN16)

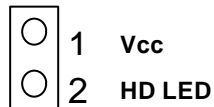

2-13. POWER LED & KEYLOCK CONNECTOR(CN13)

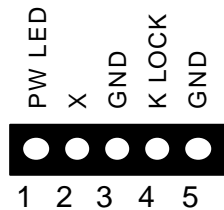

2-14. IR CONNECTOR(CN5)

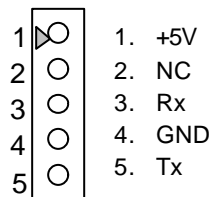

2-15. FLOPPY DISK DRIVE CONNECTOR(CN6)

FDD : Floppy Disk Drive Connector

You can use a 34-pin daisy-chain cable to connect a two-FDD. One end of this cable is to attach the FDD on the board, the other end is to attach the two-FDD.

The pin assignments are as follows:

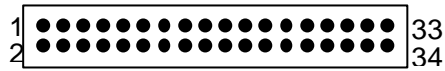

PIN	ASSIGNMENT	PIN	ASSIGNMENT
1	GND	2	DRV DEN0
3	GND	4	NC
5	GND	6	DRV DEN1
7	GND	8	INDEX
9	GND	10	MTR0
11	GND	12	DRV1
13	GND	14	DRV0
15	GND	16	MTR1
17	GND	18	DIR
19	GND	20	STEP
21	GND	22	WDATA
23	GND	24	WGATE
25	GND	26	TRK0
27	GND	28	WRPRT
29	GND	30	RDATA
31	GND	32	SEL
33	GND	34	DSKCHG

2-16. HARD DISK DRIVE CONNECTOR

IDE1: Hard Disk Drive Connector(CN1)

The AR-B1682 possess two HDD connectors, IDE1 and IDE2. The pin assignments are as follows:

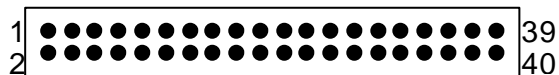

PIN	SIGNAL	PIN	SIGNAL
1	-RESET	2	GROUND
3	DATA 7	4	DATA 8
5	DATA 6	6	DATA 9
7	DATA 5	8	DATA 10
9	DATA 4	10	DATA 11
11	DATA 3	12	DATA 12
13	DATA 2	14	DATA 13
15	DATA 1	16	DATA 14
17	DATA 0	18	DATA 15
19	GROUND	20	NOT USED
21	IDEDRQA	22	GROUND
23	-LOW A	24	GROUND
25	-LOR A	26	GROUND
27	-CHRDY A	28	GROUND
29	DACKA	30	GROUND
31	-IRQ 14	32	NOT USED
33	SA 1	34	NOT USED
35	SA 0	36	SA2
37	CS 0	38	SA1
39	HD LED A	40	NOT USED

IDE2 : Hard Disk Drive Connector(CN7)

The pin assignments are as follows:

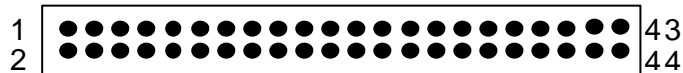

PIN	SIGNAL	PIN	SIGNAL
1	-RESET	2	GROUND
3	DATA 7	4	DATA 8
5	DATA 6	6	DATA 9
7	DATA 5	8	DATA 10
9	DATA 4	10	DATA 11
11	DATA 3	12	DATA 12
13	DATA 2	14	DATA 13
15	DATA 1	16	DATA 14
17	DATA 0	18	DATA 15
19	GROUND	20	NOT USED
21	IDEDRQA	22	GROUND
23	-LOW A	24	GROUND
25	-LOR A	26	GROUND
27	-CHRDY A	28	GROUND
29	DACKA	30	GROUND
31	-IRQ 14	32	NOT USED
33	SA 1	34	NOT USED
35	SA 0	36	SA2
37	CS 0	38	SA1
39	HD LED A	40	NOT USED
41	VCC	42	VCC
43	GROUND	44	GROUND

2-17. LCD CONNECTOR 24BIT(CN9)

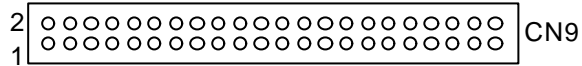

PIN	ASSIGNMENT	PIN	ASSIGNMENT
1	GND	2	SHFCLK
3	GND	4	LP
5	FLM	6	GND
7	P0	8	P1
9	P2	10	P3
11	P4	12	P5
13	GND	14	P6
15	P7	16	P8
17	P9	18	P10
19	P11	20	GND
21	P12	22	P13
23	P14	24	P15
25	P16	26	P17
27	GND	28	P18
29	P19	30	P20
31	P21	32	P22
33	P23	34	GND
35	VCC	36	VCC
37	+12V	38	+12V
39	GND	40	GND
41	DE	42	ENABLK
43	GND	44	VEE

2-18. LCD CONNECTOR 36BIT(CN9+CN11)

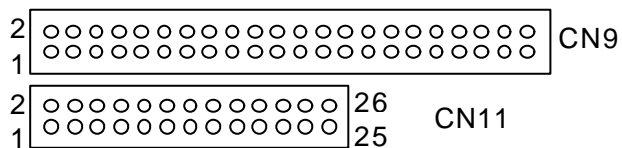

PIN	ASSIGNMENT	PIN	ASSIGNMENT
1	P24	2	P25
3	P26	4	P27
5	P28	6	P29
7	P30	8	P31
9	P32	10	P33
11	P34	12	P35
13	GND	14	GND
15	ENAVEE	16	ENAVEE
17	VCC3	18	VCC3
19	VLCD	20	VCLD
21	VCC	22	VCC
23	DDE	24	LP
25	DDE	26	M

2-19. EXTERNAL SPEAKER HEADER(CN20)

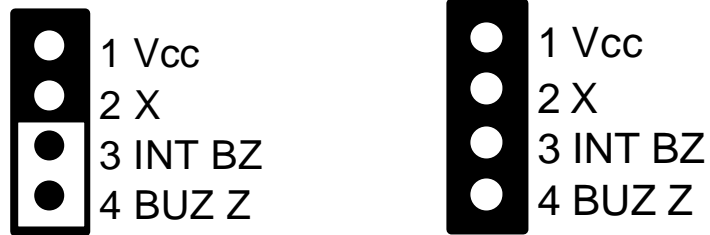

3-4 On
 Enable Internal Buzzer Enable External Buzzer

2-20. Ethernet RJ-45 Connector(CN21)

The pin assignments are as follows:

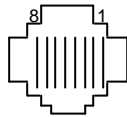

PIN	FUNCTION	PIN	ASSIGNMENT
1	TPTX+	5	NOT USED
2	TPTX+	6	TPRX-
3	TPRX+	7	NOT USED
4	NOT USED	8	NOT USED

2-21. VGA CRT CONNECTOR(CN19)

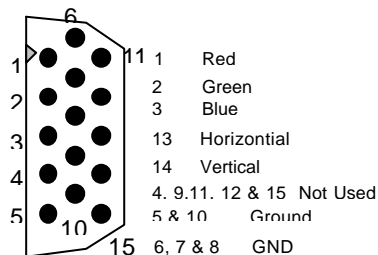

2-22. WATCHDOG CONNECTOR(CN17)



2-23. PRINTER CONNECTOR(CN2)

As to link the Printer to the card, a cable is needed to connect both DB25 connector and parallel port. The pin assignments are as follows :

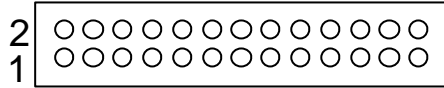

PIN	ASSIGNMENT	PIN	ASSIGNMENT
1	STB	14	AUTFE
2	P0	15	ERROR
3	P1	16	INIT
4	P2	17	SLCTIN
5	P3	18	GND
6	P4	19	GND
7	P5	20	GND
8	P6	21	GND
9	P7	22	GND
10	ACK	23	GND
11	BUSY	24	GND
12	PE	25	GND
13	SLCT	26	NC

2-24. SYSTEM FAN POWER CONNECTOR(CN27)

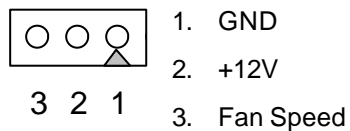

2-25. POWER ON CONNECTOR FOR ATX POWER SUPPLY(CN15)

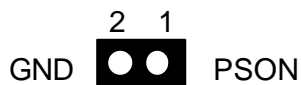

2-26. POWER CONTROL CONNECTOR(CN4)

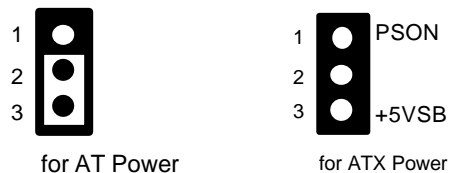

2-27. SCSI CONNECTOR(CN3)

CN3

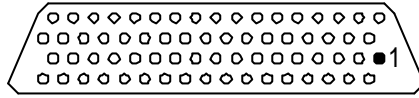

SCSI : The pin assignments are as follow:

PIN	ASSIGNMENTT	PIN	ASSIGNMENT	PIN	ASSIGNMENT
1	GND	24	GND	47	SCD7
2	GND	25	GND	48	SCDPL
3	GND	26	GND	49	GND
4	GND	27	GND	50	GND
5	GND	28	GND	51	TRMPWR
6	GND	29	GND	52	TRMPWR
7	GND	30	GND	53	NC
8	GND	31	GND	54	GND
9	GND	32	GND	55	SATTN-
10	GND	33	GND	56	GND
11	GND	34	GND	57	SBSY-
12	GND	35	SCD12	58	SACK-
13	GND	36	SCD13	59	SRST-
14	GND	37	SCD14	60	SMSG-
15	GND	38	SCD15	61	SSEL-
16	GND	39	SCDPH	62	SCD-
17	GND	40	SCD0	63	SREQ-
18	GND	41	SCD1	64	SIO-
19	NC	42	SCD2	65	SCD8
20	GND	43	SCD3	66	SCD9
21	GND	44	SCD4	67	SCD10
22	GND	45	SCD5	68	SCD11
23	GND	46	SCD6		

2-28. UNIVERSAL SERIAL BUS CONNECTOR (CN14)

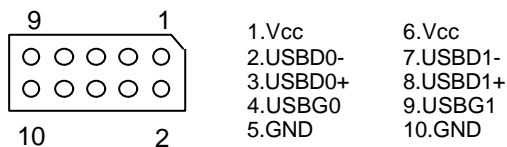

2-29. CPU FAN POWER CONNECTOR(CN26)

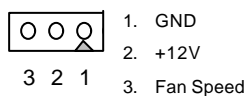

2-30. CLEAR CMOS FUNCTION(J4)

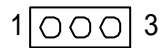

1-2:NORMAL 23:CLEAR CMOS

2-31. DOC SOCKET(U21)

DOC : 32pin Disk-on-chip Socket

The pin assignments are as follows:

PIN	ASSIGNMENT	PIN	ASSIGNMENT
1	NC	17	SD3
2	NC	18	SD4
3	NC	19	SD5
4	SA12	20	SD6
5	SA7	21	SD7
6	SA6	22	CE
7	SA5	23	SA10
8	SA4	24	OE
9	SA3	25	SA11
10	SA2	26	SA9
11	SA1	27	SA8
12	SA0	28	NC
13	SD0	29	NC
14	SD1	30	VCC
15	SD2	31	WR
16	GND	32	VCC

2-32. Touch Screen CONNECTOR(CN10)

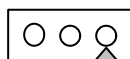

3 2 1

1. NTX2
NRX2
2. TXD
3. GND

2-33. MEMORY INSTALLING

AR-B1682 Card will support 3 SDRAM banks.

Note: DIMM 1,2,3 for double Bank SDRAM module (168pin x 32bit x 4)

DRAM BANK CONFIGURATION

DIMM 1	DIMM 2	DIMM 3	TOTAL MEMORY
32M			32M
32M	32M		64M
32M	32M	32M	96M
32M	64M		96M
32M	64M	32M	128M
32M	64M	64M	160M
32M	64M	128M	224M
32M	64M	256M	352M
32M	128M	128M	288M
32M	128M	256M	416M
32M	256M	256M	544M
64M			64M
64M	64M		128M
64M	64M	64M	192M
64M	32M	32M	128M
64M	32M	64M	160M
64M	128M		192M
64M	128M	64M	256M
64M	128M	128M	320M
64M	128M	256M	448M
64M	256M	256M	576M
128M			128M
128M	128M		256M
128M	128M	128M	384M
128M	32M	64M	224M
128M	64M	128M	320M
128M	128M	256M	512M
128M	256M	256M	640M
256M			256M
256M	256M		512M
256M	32M	64M	352M
256M	64M	128M	448M
256M	128M	128M	512M
256M	128M	256M	640M
256M	256M	256M	768M

3. SOFTWARE UTILITIES

Sections includes:

- Utility Disk File List
- Setup
- Watchdog Timer Configuration

3-1. Utility Disk File

1682_DRV#1	1682_DRV	1682_DRV#3	1682_DRV#4	1682_DRV#5	1682_DRV#6
FREEBSD	WFW311	DMI	INTEL/95	SCSIDRV	MANUAL.PDF
LINUX	NT351	WINDIAG/WIN4	INTEL/NT	W95VGA	
NDIS2DOS	MSLANMAN.DOS	BROM		WINNTVGA	
NDIS2OS2	MSLANMAN.OS2	MACOS		WD	
NWCLIENT	NWSERVER/311	RTOS			
NWSERVER/4X	NWSERVER/312	W98600.EXE			
NWSERVER/500	NWSERVER/40				
RTSPKT	CLIENT32				
SCO	UW7				
TXT	WIN95A				
WIN2000	WINDIAG/WIN2000				
W95OSR2	WINDIAG/WIN9X				
WIN98					
WINNT4					
FILEPATH.LST					
MAINNENU.TXT					
RSET8139.EXE					
VERSION.TXT					
HELP8139.EXE					
NETRTS.INF					
OEMSETUP.INF					
README.TXT					
RELEASE.DOC					

Remark:

- 1.W98600.EXE (In disk 1682_DRV#3) is a WIN98 DRIVER for VGA.
- 2.DRV#1~DRV#2 is ETHERNET DRIVER disk.
- 3.DRV#4 DISK is INTEL CHIPSET 440BX PIIX4 SETUP DRIVER
- 4.DRV#5 DISK is SCSI DRIVER FOR WIN95, NT AND WIN98, NT DRIVERS

3-2. SETUP

WIN95 VGA SETUP

To update display driver by choosing display interface card, put disk#5 in driver A, the driver of 65548 will be found, and reboot your system after setup will be ok.

WIN 95 SCSI DRIVER SETUP

The first step is to execute the file WIN9598.EXE included in folder SCSIDRV in disk#5, and then chose ' Add the new hardware ' in the console, chose the option ' Chose the hardware from the list ' , then chose the ' SCSI control card ' and ' Install from diskette, the WIN95 SCSI DRIVER of SYS53C895 will be installed.

WIN NT SCSI DRIVER SETUP

The first step is to execute A:\SCSIDRV\WINNT.EXE, a folder named ' Test ' will be built up in driver C, and the next step is to reboot the system, press F3 when you chose the display mode, enter the Load driver program display, chose the direction C:\TEST\WINNT\MINPORT, and then the SCSI DRIVER will be installed.

PIIX4 DRIVER SETUP

WIN95: The first step is to execute the INTEL\95\SETUP.EXE in DISK#4, the system will update the driver automatically, the next step is to reboot the system, and then the driver of PIIX4 CHIPSET will be installed to the system correctly.

WINNT: The first step is to execute the INTEL\NT\SETUP.EXE in DISK#4, the system will update the driver automatically, the next step is to reboot the system, and then the driver of PIIX4 CHIPSET will be installed to the system correctly.

3-3. WATCHDOG TIMER CONFIGURATION

This section describes how to use the Watchdog Timer, including disabled, enabled, and trigger functions. The AR-B1682 is equipped with a programmable time-out period watchdog timer. You can use your own program to enable the watchdog timer. Once you have enabled the watchdog timer, the program should trigger the I/O every time before the timer times out. If your program fails to trigger or disable this timer before it times out, e.g. because of a system hang-up, it will generate a reset signal to reset the system. The time-out period can be programmed to be set from 1 to 255 minutes.

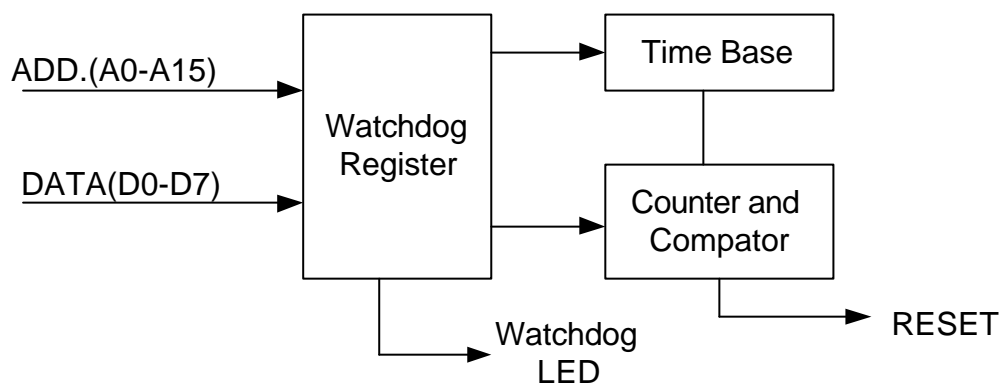

Watchdog Block Diagram

The diskette includes a Watch Dog Zip file. In the file, there are several execution programs written in different forms.

The sub-directories of the file are:

- (1) Library and Test Program written in Assembly Language
- (2) Library and Test Program written in Turbo C++

3-3-1. Watchdog Timer Setting

The watchdog timer is a circuit that may be used from your program software to detect system crashes or hang-ups. LED1 on this CPU board is the watchdog timer indicator, which is located at the upper-right corner above the 5-pin multi-function connector. Whenever the watchdog timer is enabled, the LED will blink to indicate that the timer is counting. The watchdog timer is automatically disabled after reset.

Once you have enabled the watchdog timer, your program must trigger the watchdog timer every time before it times out. After you trigger the watchdog timer, it will be set to non-zero value to watchdog counter and start to count down again. If your program fails to trigger the watchdog timer before time-out, it will generate a reset pulse to reset the system.

The factor of the watchdog timer time-out constant is approximately 1 MINUTES. The period for the watchdog timer time-out is between 1 to FF timer factors.

If you want to reset your system when watchdog times out, the following table listed the relation of timer factors between time-out period. The formula of Time-Out Period is $30+60 \times (\text{Time Factor} - 1)$. For example, if the time factor is 10. The Time-out period is calculated as $30+60 \times (10-1) = 570$.

Time Factor	Time-out Period (Seconds)
1	30
2	90
3	150
4	210
5	270
"	"
"	"
"	"
FF	"

Time out setting

3-3-2. Watchdog Timer Enabled

To enable the watchdog timer, you have to output a byte of timer factor to the watchdog. The following is a Turbo C++ program, which demonstrates how to enable the watchdog timer and set the time-out period at 24 seconds.

```
#include "stdio.H"
#include "WATCHDOG.H"
main( )
{
char WD_TIME=0x01;
printf(" Enable watchdog" );
//Set watchdog Timer Output is 30 seconds
_enable_wd (WD_TIME);
}
```

3-3-3. Watchdog Timer Trigger

After you enable the watchdog timer, your program must write the same factor as enabling to the watchdog register at least once every time-out period to its previous setting. You can change the time-out period by writing another timer factor to the watchdog register at any time, and you must trigger the watchdog before the new time-out period in the next trigger. Below is a Turbo C++ program which demonstrates how to trigger the watchdog timer:

```
#include "stdio.H"
#include "WATCHDOG.H"
main( )
{
char WD_TIME=0x01;
printf(" Trigger watchdog" );
//Set watchdog Timer Output is 30 seconds
_enable_wd(WD_TIME);
}
```

3-4-4. Watchdog Timer Disabled

To disable the watchdog timer, simply write a 00H to the watchdog register.

```
#include "stdio.H"
#include "WATCHDOG.H"
main ( )
{
printf (" Disable Watch Dog");
_disable_WD( );
}
```

4. AMI BIOS SETUP

The following topics are covered:

- BIOS Setup Overview
- Standard CMOS Setup
- Advanced CMOS Setup
- Advanced Chipset Setup
- Power Management
- PCI/Plug and Play
- Peripheral Setup
- Hardware Monitor Setup
- Auto-Detect Hard Disks
- Password Setting
- Load Default Setting
- BIOS Exit
- BIOS Update

4-1. BIOS SETUP OVERVIEW

The BIOS is a program used to initialize and set up the I/O system of the computer, which includes the PCI bus and connected devices such as the video display, diskette drive, and the keyboard.

The BIOS provides a menu-based interface to the console subsystem. The console subsystem contains special software, called firmware that interacts directly with the hardware components and facilitates interaction between the system hardware and the operating system.

The BIOS default values ensure that the system will function at its normal capability. In the worst situation the user may have corrupted the original settings set by the manufacturer.

After the computer is turned on, the BIOS will perform diagnostics on the system and display the size of the memory that is being tested. Press the [Del] key to enter the BIOS Setup program, and then the main menu will show on the screen.

The BIOS Setup main menu includes some options. Use the [Up/Down] arrow key to highlight the option that you wish to modify, and then press the [Enter] key to select the option and configure the functions.

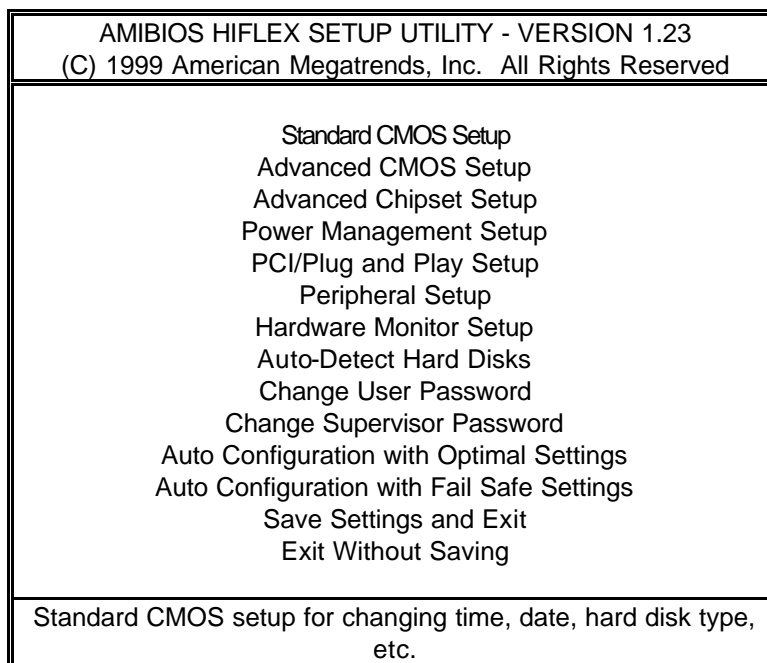

BIOS: Setup Main Menu

CAUTION:

1. In the AR-B1682 BIOS the factory-default setting is the <Auto Configuration with Optimal Settings>. Acrosser recommends using the BIOS default settings, unless you are very familiar with the settings function, or you can contact the technical support engineers (FAE).

2. If the BIOS loses the settings, the CMOS will detect the <Auto Configuration with Fail Safe Settings> to boot the operating system. This option will reduce the performance of the system. Acrosser recommends choosing the <Auto Configuration with Optimal Settings> in the main menu. This option gives best-case values that should optimize system performance.

3. The BIOS settings are described in detail in this section.

4-2. STANDARD CMOS SETUP

The <Standard CMOS Setup> option allows you to record some basic system hardware configurations and set the system clock and error handling. If the CPU board is already installed in a working system, you will not need to select this option anymore.

AMIBIOS SETUP - STANDARD CMOS SETUP	
(C) 1999 American Megatrends, Inc. All Rights Reserved	
Date (mm/dd/yyyy): Tue Jun 02, 1998	640KB
Time (hh/mm/ss): 13:39:30	63MB
Floppy Drive A: 1.44MB 3 1/2	
Floppy Drive B: Not Installed	
	LBA Blk PIO 32Bit
Type Size Cyln Head Wpcom Sec Mode Mode Mode Mode	
Pri Master : Auto	Off Off Auto Off
Pri Slave : Auto	Off Off Auto Off
Sec Master Auto	Off Off Auto Off
Sec Slave Auto	Off Off Auto Off
Boot Sector Virus Protection	Disabled
Month: Jan - Dec	ESC:Exit :Sel
Day: 01 - 31	PgUp/PgDn:Modify
Year: 1901 - 2099	F2/F3:Color

BIOS: Standard CMOS Setup

Date & Time Setup

Highlight the <Date> field and then press the [Page Up] /[Page Down] or [+]/[-] keys to set the current date. Follow the month, day and year format.

Highlight the <Time> field and then press the [Page Up] /[Page Down] or [+]/[-] keys to set the current date. Follow the hour, minute and second format.

The user can bypass the date and time prompts by creating an AUTOEXEC.BAT file. For information on how to create this file, please refer to the MS-DOS manual.

Floppy Setup

The <Standard CMOS Setup> option records the types of floppy disk drives installed in the system.

To enter the configuration value for a particular drive, highlight its corresponding field and then select the drive type using the left-or right-arrow key.

Hard Disk Setup

The BIOS supports various types for user settings, The BIOS supports <Pri Master> and <Pri Slave> so the user can install up to two hard disks. For the master and slave jumpers, please refer to the hard disk's installation descriptions and the hard disk jumper settings.

You can select <AUTO> under the <TYPE> and <MODE> fields. This will enable auto detection of your IDE drives during bootup. This will allow you to change your hard drives (with the power off) and then power on without having to reconfigure your hard drive type. If you use older hard disk drives which do not support this feature, then you must configure the hard disk drive in the standard method as described above by the <USER> option.

Boot Sector Virus Protection

This option protects the boot sector and partition table of your hard disk against accidental modifications. Any attempt to write to them will cause the system to halt and display a warning message. If this occurs, you can either allow the operation to continue or use a bootable virus-free floppy disk to reboot and investigate your system. The default setting is <Disabled>. This setting is recommended because it conflicts with new operating systems. Installation of a new operating systems requires that you disable this to prevent write

errors.

4-3. ADVANCED CMOS SETUP

The <Advanced CMOS Setup> option consists of configuration entries that allow you to improve your system performance, or let you set up some system features according to your preference. Some entries here are required by the CPU board's design to remain in their default settings.

AMIBIOS SETUP - ADVANCED CMOS SETUP (C) 1999 American Megatrends, Inc. All Rights Reserved		
Quick Boot	Enabled	Available Options : Disabled Enabled
1st Boot Device	Floppy	
2nd Boot Device	IDE-0	
3rd Boot Device	CDROM	
4th Boot Device	Disabled	
Try Other Boot Devices	Yes	
Floppy Access Control	Read-Write	
Hard Disk Access Control	Read-Write	
S.M.A.R.T. for Hard Disks	Enabled	
BootUp Num-Lock	On	
Floppy Drive Swap	Disabled	
Floppy Drive Seek	Disabled	
PS/2 Mouse Support	Enabled	
TypeMance Rate	Fast	
System Keyboard	Absent	
Primary Display	VGA/EGA	
Password Check	Setup	
Boot to OS/2 > 64MB	No	
Wait For 'F1' If Error	Disabled	
Hit 'DEL' Message Display	Enabled	
Internal Cache	WriteBack	
External Cache	WriteBack	
Cache Bus Ecc	Enabled	
System BIOS Cacheable	Enabled	
C000, 16k Shadow	Enabled	
C400, 16k Shadow	Enabled	
C800, 16k Shadow	Enabled	
CC00, 16k Shadow	Disabled	ESC:Exit :Sel
D000, 16k Shadow	Disabled	PgUp/PgDn:Modify
D400, 16k Shadow	Disabled	F2/F3:Color
D800, 16k Shadow	Disabled	
DC00, 16k Shadow	Disabled	

Advanced CMOS Setup

Quick Boot

This category speeds up the <Power On Self Test> (POST) after you power on the computer. If it is set to *Enabled*, the BIOS will shorten or skip some check items during POST.

1st Boot Device

2nd Boot Device

3rd Boot Device

4th Boot Device

These options determine where the system looks first for an operating system.

Try Other Boot Devices

If you have other bootup device other than the above mentioned devices, such as IDE-0, IDE-1, IDE-3, IDE-4, Floppy.

Floppy Access Control

This option determines the floppy access method, which can be either read only or normal (read/write). When set to read only, the data in the floppy is allowed to be read instead of being written." Normal" allows the floppy to be read or written.

HDD Access Control

This option determines the hard disk access method, which can be either read only or normal (read/write). When set to read only, the data in the hard disk is allowed to be read instead of being written." Normal" allows the floppy to be read or written.

Available options: *Disabled, Enabled*

S.M.A.R.T for hard Disks

S.M.A.R.T is abbreviation of Self-Monitoring Analysis and Reporting Technology .It is reliable and precautions technology. When Hard Disk disorder, It prevents Hard Disk from the loss of data.

BootUp Num-Lock

This item is used to activate the Num-Lock function upon system boot. If the setting is on, after a boot, the Num-Lock light is lit, and the user can automatically use the number keys.

Floppy Drive Swap

The option reverses the drive letter assignments of your floppy disk drives in the Swap A, B setting, otherwise leave on the setting to *Disabled* (No Swap).This works separately from the BIOS Features floppy disk swap feature. It is functionally the same as physically interchanging the connectors of the floppy disk drives. When *<Enabled>*, the BIOS swaps the floppy drive assignments so that Drive A becomes Drive B, and Drive B becomes Drive A under DOS.

Floppy Drive Seek

If the *<Floppy Drive Seek>* item is set to *Enabled*, the BIOS will seek the floppy *<A>* drive one time upon bootup.

PS/2 Mouse Support

The setting of *Enabled* allows the system to detect a PS/2 mouse on bootup. If detected, IRQ12 will be used for the PS/2 mouse. IRQ 12 will be reserved for expansion cards if a PS/2 mouse is not detected. *Disabled* will reserve IRQ12 for expansion cards and therefore the PS/2 mouse will not function.

Typematic Rate

This item specifies the speed at which a keyboard keystroke is repeated.

System Keyboard

The setting of *<Absent>* allows the system to boot without a keyboard attached to the computer, the setting of *<Present>* is in the contrary.

Primary Display

The setting of *<Absent>* allows the system to boot without a Primary Display attached to the computer, the setting of *<Present>* is in the contrary.

Password Check

This option enables password checking every time the computer is powered on or every time the BIOS Setup is executed. If *Always* is chosen, a user password prompt appears every time the computer is turned on. If *Setup* is chosen, the password prompt appears if the BIOS is executed.

Boot to OS/2 >64MB

When using the OS/2 operating system with DRAM of greater than 64MB installed, you need to *Enabled* this option; otherwise leave this on the setup default of *Disabled*.

Wait for ' F1' If Error

AMIBIOS POST error messages are followed by:

Press *<F1>* to continue

If this option is set to *Disabled*, the AMIBIOS does not wait for you to press the *<F1>* key after an error message.

Hit 'DEL' Message Display

Set this option to **Disabled** to prevent the following message:

Hit 'DEL' if you want to run setup

It will prevent the message from appearing on the first BIOS screen when the computer boots.

Internal Cache

This option specifies the caching algorithm used for the L1 internal cache memory. The settings are:

Setting	Description
Disabled	Neither L1 internal cache memory on the CPU or L2 secondary cache memory is enabled.
WriteBack	Use the write-back caching algorithm.
WriteThru	Use the write-through caching algorithm.

Internal Cache Setting

External Cache

This option specifies the caching algorithm used for the L2 secondary cache memory. The settings are:

Setting	Description
Disabled	Neither L1 internal cache memory on the CPU or L2 secondary cache memory is enabled.
WriteBack	Use the write-back caching algorithm.
WriteThru	Use the write-through caching algorithm.

External Cache Setting

Cache Bus ECC

This item is to set up the function of Cache Bus Error Correction Code, choose **<Enabled>** or **<Disabled>** to determine if the function is available.

System BIOS Cacheable

This item is used to activate the function of re-buffering the contents of shadow RAM from system BIOS. The default setting is **<Enable>**, which will improve the speed of system.

Shadow

These options control the location of the contents of the 16KB of ROM beginning at the specified memory location. If no adapter ROM is using the named ROM area, this area is made available to the local bus. The settings are:

SETTING	DESCRIPTION
Disabled	The video ROM is not mapped to RAM. The contents of the video ROM cannot be read from or written to cache memory.
Enabled	The contents of C000h - C7FFFh are written to the same address in system memory (RAM) for faster execution.
Cached	This option specifies the size of the memory area reserved for legacy ISA adapter cards.

Shadow Setting

4-4. ADVANCED CHIPSET SETUP

This option controls the configuration of the board's chipset. Control keys for this screen are the same as for the previous screen.

AMIBIOS SETUP - ADVANCED CHIPSET SETUP (C) 1999 American Megatrends, Inc. All Rights Reserved		
Configure SDRAM Timing by SPD	Enabled	Available Options : Disabled Enabled
SDRAM RAS# to CAS# delay	2 SCLKs	
RAS# Precharge	2 SCLKs	
CAS# Latency	3 SCLKs	
Loadoff Cmd Timing	Auto	
DRAM Integrity Mode	Non-ECC	
Memory Hole	Disabled	
Graphics Aperture Size	64MB	
8bit I/O Recovery Time	1 Sysclk	
16bit I/O Recovery Time	1 Sysclk	
USB Function	Enabled	
USB Keyboard / Mouse Legacy Support	Enabled	
ATX Power Supply Controller	Disabled	ESC:Exit :Sel
LCD CRT Selection	Both	PgUp/PgDn:Modify
LCD Type	#5 640x480 TFT	F2/F3:Color

BIOS: Advanced Chipset Setup

Configure SDRAM Timing by SPD:

SPD is the abbreviation Serial Presence Detect. SPD takes accord the chip types, capacity, timing, voltage data. The system can auto adjust memory according to the data to reach the best situation.

SDRAM RAS# to CAS# delay:

When CPU save data from memory, it has to deliver RAS single first, and then CAS single. The item is to set up the interval between two singles.

RAS# Precharge:

This item is the time when RAS has to re-located.

CAS# Latency:

This item is to set up the time when memory receives one CAS single, after how much clock, the memory starts to write and read data.

Loadoff Cmd Timing:

It is the first read-write action under burst pattern

Memory Hole:

This reserves the 15MB to 16MB memory address space for use of ISA expansion cards.

Graphics Aperture Size:

The item is to set up AGP display to use how much memory to save Texture Data.

8 bit I/O Recovery Time:

The item is to set up CPU to demand ISA Bus 8 bit how much it takes to recovery.

16 bit I/O Recovery Time:

The item is to set up CPU to demand ISA Bus 16 bit how much it takes to recovery.

Memory Hole at 15-16 MB

This option specifies the range 15MB to 16MB in memory that cannot be addressed on the ISA bus.

USB Function

This option can enable or disable USB function

USB Keyboard/Mouse Legacy Support

These options are used to *<Enabled>* the USB function and it's only useful in the DOS mode.

ATX Power Supply Controller

If the ATX Power Supply Controller function is *<Enabled>*, the system will get more functions such as shutting down the power by using software .

LCD CRT Selection

This item determines whether to use LCD Monitor or CRT Monitor in the system.

LCD Type

This option specifies the resolution of LCD.

4-5. POWER MANAGEMENT

This section is used to configure the power management features. This <Power management Setup> option allows you to reduce power consumption. This feature turns off the video display and shuts down the hard disk after a period of inactivity.

MIBIOS SETUP - Power Management Setup (C) 1998 American Megatrends, Inc. All Rights Reserved		
Power Management /APM	Disab led	Available Options : Disabled Enabled
Green PC Monitor Power State	Off	
Video Power Down Mode	Disabled	
Hard Disk Power Down Mode	Disabled	
Hard Disk Time Out (Minute)	Disabled	
Standby Time Out (Minute)	Disabled	
Suspend Time Out (Minute)	Disabled	
Throttle slow Clock Ratio	25-37.5%	
Modem Use IO Port	3F8h/COM1	
Modem Use IRQ	3	
Display Activity	Ignore	
Device 6 (Serial Port 1)	Monitor	
Device 7 (Serial Prot 2)	Monitor	
Device 8 (Parallel Port)	Ignore	
Device 5 (Floppy disk)	Monitor	
Device 0 (Primary master IDE)	Monitor	
Device 1 (Primaryslave IDE)	Ignore	
Device 2 (Secondary master IDE)	Monitor	
Device 3 (Secondary slave IDE)	Ignore	
System Thermal	Ignore	
Thermal Slow Clock Ratio	50-62.5%	
CPU Critical Tempera ture	65 /149	
Power Button Function	On/Off	ESC:Exit :Sel
Restore on AC/Power Loss	Last State	PgUp/PgDn:Modify
Ring Resume From Soft Off	Disabled	F2/F3:Color
Lan Resume From Soft Off	Disabled	

BIOS: Power Management Setup

Power Management /APM

Enabled this option is to enable the power management and APM (Advanced Power Management) features.

Green PC Monitor Power State

This option specifies the suspend mode of shutting down the cathode ray gun, if only the system is fixed a green function monitor, the power saving function is available.

Video Power Down Mode

This option specifies the power management state that the video subsystem enters after specified period of display inactivity has expired.

Hard Disk Power Down Mode

This option specifies the power management states that the hard disk drive enters after the specified period of display inactivity has expired.

Hard Disk time out(minute)

This item is used to set up the initial value of the waiting timer .the Hard Disk will turn into the suspend mode when the time is out if no operation applied to Hard Disk .

Standby Time Out (minute)

This item is used to set up the initial value of the waiting timer, the System will turn into the suspend mode when the time is out if no operation applied to system.

Suspend Time Out(minute)

These options specify the length of the period of system inactivity when the computer is already in Standby mode before the computer is placed on Suspend mode. In Suspend mode, nearly all power use is curtailed.

Throttle Slow Clock Ratio

This item is to set up the Operating Frequency of system clock in power saving mode, to set a suitable clock frequency ratio which between standard CPU clock and CPU clock in power saving mode when the system is in suspend mode.

Modem Use IO Port

To chose a suitable IO Port in this option.

Modem use IRQ

To chose the IRQ Signal.

Device

These options enable event monitoring. When the computer is in a power saving mode, activity on the named interrupt request line is monitored by BIOS. When any activity occurs, the computer enters Full On mode.

System Thermal

If the choice <monitor>is chose, the system will alarm when the system temperature is beyond the critical temperature.

Thermal Slow Clock Ratio

This item is to set up the Operating Frequency of system clock in power saving mode, to set a suitable clock frequency ratio which between standard CPU clock and CPU clock in power saving mode when the temperature is beyond the critical temperature.

Restore on AC/Power Loss

This item is to set up the system will restore with the last setting after the AC\Power Loss.

Ring Resume From Soft Off

This item is set up to awake the system from suspend mode and a ring bell while any access coming from modem.

Lan Resume From Soft Off

This item is set up to awake the system from suspend mode when encounter a network access, the function will be available if system is fixed with an Ethernet card.

4-6. PCI/PLUG AND PLAY

This section is used to configure PCI / Plug and Play features. The <PCI & PNP Setup> option configures the PCI bus slots. All PCI bus slots on the system use INTA#, thus all installed PCI cards must be set to this value.

AMIBIOS SETUP - PCI/PLUG AND PLAY SETUP (C) 1998 American Megatrends, Inc. All Rights Reserved		
Plug and Play Aware O/S	Yes	Available Options : Yes No
Clear NVRAM	No	
On board PCI LAN Controller	Enabled	ESC:Exit :Sel PgUp/PgDn:Modify F2/F3:Color
PCI Latency Timer (PCI Clocks)	64	
Primary Graphic Adapter	PCI	
PCI VGA Palette Snoop	Disabled	
PCI IDE BusMaster	Disabled	
PCI Slot1 IRQ Priority	Auto	
PCI Slot2 IRQ Priority	Auto	
PCI Slot3 IRQ Priority	Auto	
PCI Slot4 IRQ Priority	Auto	
DMA Channel 0	PnP	
DMA Channel 1	PnP	
DMA Channel 3	PnP	
DMA Channel 5	PnP	
DMA Channel 6	PnP	
DMA Channel 7	PnP	
IRQ 3	ISA/EISA	
IRQ 4	ISA/EISA	
IRQ 5	PCI /PnP	
IRQ 7	ISA/EISA	
IRQ 9	PCI /PnP	
IRQ 10	PCI /PnP	
IRQ 11	PCI /PnP	
IRQ 12	PCI /PnP	
IRQ 14	PCI /PnP	
IRQ 15	PCI /PnP	
Reserved Memory Size	32K	
Reserved Memory Address	CC000	

BIOS: PCI / Plug and Play Setup

Plug and Play Aware O/S

Set this option to <No> if the operating system installed in the computer is Plug and Play-aware. The BIOS only detects and enables PnP ISA adapter cards that are required for system boot. The Windows 95 (and above) operating system detects and enables all other PnP-aware adapter cards. Windows 95 (and above) is PnP-aware. Set this option to <yes> if the operating system (such as DOS, OS/2, Windows 3.x) does not use PnP. You must set this option correctly or PnP-aware adapter cards installed in your computer will not be configured properly.

Clear NVRAM

This sets the operating mode of the boot block area of the BIOS FLASH ROM to allow programming in the Yes setting.

On board PCI LAN Controller

This option is to activate the PNP(Plug & Play) function of LAN.

PCI Latency Timer (PCI Clocks)

This option sets latency of all PCI devices on the PCI bus. The settings are in units equal to PCI clocks.

Primary Graphic Adapter

This option is set to use PCI bus or AGP. The AGP mode will get system a faster processing speed.

PCI VGA Palette Snoop

This item is for BIOS to snoop the appearance of VGA palette, and modify it when necessary.

PCI IDE BusMaster

When *Enabled* this option specifies that the IDE controller on the PCI local bus has bus mastering capability.

PCI Slot1/2/3/4 IRQ Priority

The parameters of this item will set a interrupt signal to the PCI device fixed in the 1-4 PCI slot by priority.

DMA & IRQ

These options specify the bus that the named IRQs/DMA lines are used on. These options allow you to specify IRQs/DMA for use by legacy ISA adapter cards. These options determine if the BIOS should remove an IRQ/DMA from the pool of availability of IRQs/DMA passed to the BIOS configurable devices. If more IRQs/DMA must be removed from the pool, the end user can use these PCI/PnP Setup options to remove the IRQ/DMA by assigning the option to the ISA/EISA setting. The onboard I/O is configurable with BIOS.

Reserved Memory Size

This option specifies the size of the memory area reserved for legacy ISA adapter cards.

Reserved Memory Address

This option specifies the beginning address (in hex) of the reserved memory area. The specified ROM memory area is reserved for use by legacy ISA adapter cards.

4-7. PERIPHERAL SETUP

This section is used to configure the peripheral features.

AMIBIOS SETUP - PCI/PLUG AND PLAY SETUP (C) 1998 American Megatrends, Inc. All Rights Reserved		
Plug and Play Aware O/S	Yes	Available Options : Yes No
Clear NVRAM	No	
On board PCI LAN Controller	Enabled	ESC:Exit :Sel PgUp/PgDn:Modify F2/F3:Color
PCI Latency Timer (PCI Clocks)	64	
Primary Graphic Adapter	PCI	
PCI VGA Palette Snoop	Disabled	
PCI IDE BusMaster	Disabled	
PCI Slot1 IRQ Priority	Auto	
PCI Slot2 IRQ Priority	Auto	
PCI Slot3 IRQ Priority	Auto	
PCI Slot4 IRQ Priority	Auto	
DMA Channel 0	PnP	
DMA Channel 1	PnP	
DMA Channel 3	PnP	
DMA Channel 5	PnP	
DMA Channel 6	PnP	
DMA Channel 7	PnP	
IRQ 3	ISA/EISA	
IRQ 4	ISA/EISA	
IRQ 5	PCI /PnP	
IRQ 7	ISA/EISA	
IRQ 9	PCI /PnP	
IRQ 10	PCI /PnP	
IRQ 11	PCI /PnP	
IRQ 12	PCI /PnP	
IRQ 14	PCI /PnP	
IRQ 15	PCI /PnP	
Reserved Memory Size	32K	
Reserved Memory Address	CC000	

BIOS: Peripheral Setup

OnBoard FDC

This option enables the floppy drive controller on the AR-B1682.

OnBoard Serial Port

This option enables the serial port on the AR-B1682.

IR Port support

This item is to activate the function of Infra-red.

OnBoard Parallel Port

This option enables the parallel port on the AR-B1682.

Parallel Port Mode

This option specifies the parallel port mode. ECP and EPP are both bi-directional data transfer schemes that adhere to the IEEE1284 specifications.

Parallel Port DMA Channel

This option is only available if the setting for the parallel Port Mode option is ECP.

K/B Wake-Up function

This item is to set up the function of waking-up the system by Keyboard from suspend mode.

Mouse Wake-up function

This item is to set up the function of waking-up the system by Mouse from suspend mode.

OnBoard IDE

This option is to set up the operating mode of IDE controller. If the main board offer the enhanced I/O port, the choice should be *<enabled>* .

Reset, Power, Sleep Button

These options are to activate the Reset, Power, and Sleep function in the ATX Keyboard.

4-8. AUTO-DETECT HARD DISKS

This option detects the parameters of an IDE hard disk drive, and automatically enters them into the Standard CMOS Setup screen.

4-9. PASSWORD SETTING

This BIOS Setup has an optional password feature. The system can be configured so that all users must enter a password every time the system boots or when BIOS Setup is executed. The user can set either a Supervisor password or a User password.

4-10. Setting the Password

Select the appropriate password icon (Supervisor or User) from the Security section of the BIOS Setup main menu. Enter the password and press [Enter]. The screen does not display the characters entered. After the new password is entered, retype the new password as prompted and press [Enter].

If the password confirmation is incorrect, an error message appears. If the new password is entered without error, press [Esc] to return to the BIOS Main Menu. The password is stored in CMOS RAM after the BIOS is exited and saved. The next time the system boots, you are prompted for the password.

Enter new supervisor password:

4-11. Password Checking

The password check option is enabled in Advanced Setup by choosing either *Always* (the password prompt appears every time the system is powered on) or *Setup* (the password prompt appears only when BIOS is run). The password is stored in CMOS RAM. User can enter a password by typing on the keyboard. As user select Supervisor or User. The BIOS prompts for a password, user must set the Supervisor password before user can set the User password. Enter a 1 to 6 characters password. The password does not appear on the screen when typed. Make sure you write it down.

4-12. LOAD DEFAULT SETTING

This section permits users to select a group of settings for all BIOS Setup options. Not only can you use

these items to quickly set system configuration parameters, you can choose a group of settings that have a better chance of working when the system is having configuration related problems.

4-12-1. Auto Configuration with Optimal Setting

The user can load the optimal default settings for the BIOS. The Optimal default settings are best-case values that should optimize system performance. If CMOS RAM is corrupted, the optimal settings are loaded automatically.

Load high performance setting (Y/N) ?

4-12-2. Auto Configuration with Fail Safe Setting

The user can load the Fail-Safe BIOS Setup option settings by selecting the Fail-Safe item from the Default section of the BIOS Setup main menu.

The Fail-Safe settings provide far from optimal system performance, but are the most stable settings. Use this option as a diagnostic aid if the system is behaving erratically.

Load failsafe settings (Y/N) ?

4-13. BIOS EXIT

This section is used to exit the BIOS main menu. After making your changes, you can either save them or exit the BIOS menu and without saving the new values.

4-13-1. Save Settings and Exit

This item is in the <Standard CMOS Setup>, <Advanced CMOS Setup>, <Advanced Chipset Setup> and the new password (if it has been changed) will be stored in the CMOS. The CMOS checksum is calculated and written into the CMOS.

When you select this function, the following message will appear at the center of the screen to assist you to save data to CMOS and Exit the Setup.

Save current settings and exit (Y/N) ?

4-13-2. Exit Without Saving

When you select this option, the following message will appear at the center of the screen to help to abandon all the modified data and Exit Setup.

Quit without saving (Y/N) ?

4-14. BIOS UPDATE

The BIOS program instructions are contained within computer chips called FLASH ROMs that are located on your system board. The chips can be electronically reprogrammed, allowing you to upgrade your BIOS firmware without removing and installing chips.

The AR-B1682 provides the FLASH BIOS update function for you to easily to update to a newer BIOS version. Please follow these operating steps to update to a new BIOS:

Step 1: Turn on your system and don't detect the CONFIG.SYS and AUTOEXEC.BAT files.

Step 2: Insert the FLASH BIOS diskette into the floppy disk drive.

Step 3: In the MS-DOS mode, you can type the FLASH812 program.

```
A:\>FLASH812
```

Step 4: Press [ALT+F], The <File> box will show the following message, this message will be highlighted.

```
BIOS Filename Loading ... . After typing in the File name you must press<ENTER> or  
press <ESC> to exit.
```

Step 5: And then please enter the file name to the <Enter File Name> box. And the <Message> box will show the following notice.

```
Are you sure to write this BIOS into flash ROM?
```

Step 6: Press the <Enter> key to update the new BIOS.
Then the <Message> box will show the <Programming now ...>.

Step 7: When the BIOS update is successful, the message will show <Flash ROM Update Completed - Pass>.

NOTE: The BIOS Flash disk is not a standard accessory. Now that the onboard BIOS is updated to the newest version, if you need to add some functions in the future please contact the technical support (FAE) engineers. They will provide the newest known BIOS for update engineers. They will provide the newest known BIOS for update.

APPENDIX A

EXPANSION BUS

This chapter includes:

- ISA BUS Pin Assignment
- PICMG BUS Pin Assignment

A-1. ISA BUS PIN ASSIGNMENT

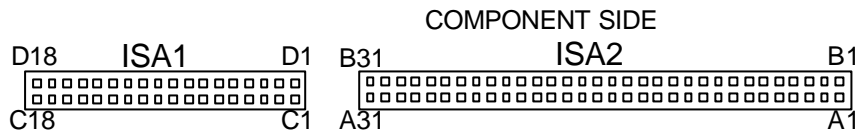

There are two edge connectors (called " gold fingers ") on this CPU Card. On the right hand is the connector of ISA Bus, beside PCI BUS connector. The ISA-bus connector is divided into two sets: one consists of 62 pins; the other consists of 36 pins.

The pin assignments are as follows:

B		A		D		C	
PIN	ASSIGNMENT	PIN	ASSIGNMENT	PIN	ASSIGNMENT	PIN	ASSIGNMENT
B1	GND	A1	-/O CH CHK	D1	-MEMCS16	C1	SBHE
B2	RESET	A2	SD07	D2	-/OCS16	C2	LA23
B3	+5V	A3	SD06	D3	IRQ10	C3	LA22
B4	IRQ9	A4	SD05	D4	IRQ11	C4	LA21
B5	-5V	A5	SD04	D5	IRQ12	C5	LA20
B6	DRQ2	A6	SD03	D6	IRQ15	C6	LA19
B7	-12V	A7	SD02	D7	IRQ14	C7	LA18
B8	OVS	A8	SD01	D8	-DACK0	C8	LA17
B9	+12V	A9	SD00	D9	DRQ0	C9	-MEMR
B10	GND	A10	-/O CH RDY	D10	-DACK5	C10	-MEMW
B11	-SMEMW	A11	AEN	D11	DRQ5	C11	SD08
B12	-SMEMR	A12	SA19	D12	-DACK6	C12	SD09
B13	-IOW	A13	SA18	D13	DRQ6	C13	SD10
B14	-IOR	A14	SA17	D14	-DACK7	C14	SD11
B15	-DACK3	A15	SA16	D15	DRQ7	C15	SD12
B16	-DRQ3	A16	SA15	D16	+5V	C16	SD13
B17	-DACK1	A17	SA14	D17	-MASTER	C17	SD14
B18	-DRQ1	A18	SA13	D18	GND	C18	SD15
B19	-REFRESH	A19	SA12				
B20	BCLK	A20	SA11				
B21	IRQ7	A21	SA10				
B22	IRQ6	A22	SA09				
B23	IRQ5	A23	SA08				
B24	IRQ4	A24	SA07				
B25	IRQ3	A25	SA06				
B26	-DACK2	A26	SA05				
B27	T/C	A27	SA04				
B28	BALE	A28	SA03				
B29	+5V	A29	SA02				
B30	OSC	A30	SA01				
B31	GND	A31	SA00				

A-2. PICMG BUS PIN ASSIGNMENT

Like ISA-BUS connector, the PICMG-BUS edge connector is divided into two sets as well: one consists of 98 pins, and the other 22 pins. The pin assignments are as follows:

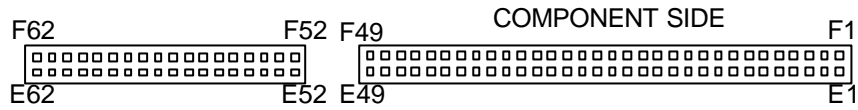

F		E		F		E	
PIN	ASSIGNMENT	PIN	ASSIGNMENT	PIN	ASSIGNMENT	PIN	ASSIGNMENT
F1	-12V	E1	TRST#	F31	+3.3V	E31	AD18
F2	TCK	E2	+12V	F32	AD17	E32	AD16
F3	GND	E3	TMS	F33	C/BE2#	E33	+3.3V
F4	TDO	E4	TDI	F34	GND	E34	FRAME#
F5	+5V	E5	+5V	F35	IRDY#	E35	GND
F6	+5V	E6	INTA#	F36	+3.3V	E36	TRDY#
F7	INTB#	E7	INTC#	F37	DEVSEL#	E37	GND
F8	INTD#	E8	+5V	F38	GND	E38	STOP#
F9	PRSENT1#	E9	NC	F39	LOCK#	E39	+3.3V
F10	NC	E10	+5V	F40	PERR#	E40	SDONE
F11	PRSENT2#	E11	NC	F41	+3.3V	E41	SB0#
F12	GND	E12	GND	F42	SERR#	E42	GND
F13	GND	E13	GND	F43	+3.3V	E43	PAR
F14	NC	E14	NC	F44	C/BE1#	E44	AD15
F15	GND	E15	RST#	F45	AD14	E45	+3.3V
F16	CLK	E16	+5V	F46	GND	E46	AD13
F17	GND	E17	GNT#	F47	AD12	E47	AD11
F18	REQ#	E18	GND	F48	AD10	E48	GND
F19	+5V	E19	NC	F49	GND	E49	AD09
F20	AD31	E20	AD30	F52	AD8	E52	C/BE0#
F21	AD29	E21	+3.3V	F53	AD7	E53	+3.3V
F22	GND	E22	AD28	F54	+3.3V	E54	AD6
F23	AD27	E23	AD26	F55	AD5	E55	AD4
F24	AD25	E24	GND	F56	AD3	E56	GND
F25	+3.3V	E25	AD24	F57	GND	E57	AD2
F26	C/BE3#	E26	IDSEL	F58	AD1	E58	AD0
F27	AD23	E27	+3.3V	F59	+5V(I/O)	E59	+5V(I/O)
F28	GND	E28	AD22	F60	ACK64#	E60	REQ64#
F29	AD21	E29	AD20	F61	+5V	E61	+5V
F30	AD19	E30	GND	F62	+5V	E62	+5V

APPENDIX B

TECHNICAL SUMMARY

This chapter focus on:

- Interrupt Map
- RTC & CMOS RAM Map
- Timer & DMA Channels Map
- I / O & Memory Map

B-1. INTERRUPT MAP

IRQ	ASSIGNMENT
0	System TIMER interrupt from TIMER-0
1	Keyboard output buffer full
2	Cascade for IRQ 8-15
3	Serial port 2
4	Serial port 1
5	Parallel port 2
6	Floppy Disk adapter
7	Parallel port 1
8	RTC clock
9	Available
10	Available
11	Available
12	Available
13	Math coprocessor
14	Hard Disk adapter
15	Available

B-2. RTC & CMOS RAM MAP

CODE	ASSIGNMENT
00	Seconds
01	Second alarm
02	Minutes
03	Minutes alarm
04	Hours
05	Hours alarm
06	Day of week
07	Day of month
08	Month
09	Year
0A	Status register A
0B	Status register B
0C	Status register C
0D	Status register D
0E	Diagnostic status byte
0F	Shutdown byte
10	Floppy Disk drive type byte
11	Reserve
12	Hard Disk type byte
13	Reserve
14	Equipment byte
15	Base memory low byte
16	Base memory high byte
17	Extension memory low byte
18	Extension memory high byte
30	Reserved for extension memory low byte
31	Reserved for extension memory high byte
32	Date Century byte
33	Information Flag
34-3F	Reserve
40-7f	Reserved for Chipset Setting Data

B-3. TIMER & DMA CHANNELS MAP

Timer Channel Map :

Timer Channel	Assignment
0	System timer interrupt
1	DRAM Refresh request
2	Speaker tone generator

DMA Channel Map :

DMA Channel	Assignment
0	Available
1	IBM SDLC
2	Floppy Disk adapter
3	Channel-3 Available
4	Cascade for DMA controller 1
5	Available
6	Available
7	Available

B-4. I/O & MEMORY MAP

Memory Map :

MEMORY MAP	ASSIGNMENT
0000000-009FFFF	System memory used by DOS and application
00A0000-00BFFFF	Display buffer memory for VGA/ EGA / CGA / MONOCHROME adapter
00C0000-00DFFFF	Reserved for I/O device BIOS ROM or RAM buffer.
00E0000-00EFFFF	Reserved for PCI device ROM
00F0000-00FFFFFF	System BIOS ROM
0100000-FFFFFFF	System extension memory

I/O Map :

I/O MAP	ASSIGNMENT
000-01F	DMA controller (Master)
020-021	Interrupt controller (Master)
022-023	Chipset controller registers I/O ports.
040-05F	Timer control registers.
060-06F	Keyboard interface controller (8042)
070-07F	RTC ports & CMOS I/O ports
080-09F	DMA register
0A0-0BF	Interrupt controller (Slave)
0C0-0DF	DMA controller (Slave)
0F0-0FF	Math coprocessor
1F0-1F8	Hard Disk controller
278-27F	Parallel port-2
2B0-2DF	Graphics adapter controller
2F8-2FF	Serial port-2
360-36F	Net work ports
378-37F	Parallel port-1
3B0-3BF	Monochrome & Printer adapter
3C0-3CF	EGA adapter
3D0-3DF	CGA adapter
3F0-3F7	Floppy disk controller
3F8-3FF	Serial port-1

APPENDIX C

TROUBLE SHOOTING

TROUBLE SHOOTING FOR ERROR MESSAGES

The following information will present the resolution of trouble encountered as well as the error messages. Adjust the system following the messages below and make sure all the components & connectors are in proper position and firmly attached. If the error still remains, contact with your distributor for maintenance.

POST BEEP :

There are two kinds of beep codes in BIOS. One code indicates that a video error has occurred and the BIOS cannot initialize the video screen to display any additional information. This beep code contains a single long beep followed by three short beeps. The other code indicates that DRAM error has incurred. This beep code appears a single long beep repeatedly.

CMOS BATTERY FAILURE :

When the CMOS battery is out of work or has run out, the user has to replace it with a new battery same as the old one.

CMOS CHECKSUM ERROR :

When the battery runs weak, CMOS will be corrupted. Check the battery and change a new one when necessary.

DISPLAY SWITCH IS SET INCORRECTLY:

Display switch on the motherboard can be set to either monochrome or colour, which indicates the switch is set to a different setting from the indicated in Setup. Determine which setting is correct, and then either turn off the system and change the jumper, or enter Setup and change the video selection.

DISK BOOT FAILURE:

When boot device isn't available, insert a system disk into Drive A and press < Enter >. Make sure both the controller and cables are all in proper positions, also make sure the disk is formatted correct device. Then reboot the system.

DISKETTE DRIVES OR TYPES MISMATCH ERROR :

If the diskette drive type is different from CMOS, run setup and correct it .

ERROR ENCOUNTERED INITIALIZING HARD DRIVE :

When hard drive can't be initialized, make sure the adapter is installed correctly and all cables are properly and firmly attached. Also be sure the correct hard drive type is selected in Setup.

ERROR INITIALIZING HARD DISK CONTROLLER:

When error occurs, be sure the cord is exactly installed in the bus and the correct hard drive type is selected in Setup. Besides that, check whether all of the jumpers in the hard drive are set correctly.

FLOPPY DISK CONTROLLER ERROR OR NO CONTROLLER PRESENT:

When fail to find or initialize the floppy drive controller, check whether the controller in proper station. If there are no floppy drive installed, Ensure the Diskette Drive selection in Setup is set to NONE.

KEYBOARD ERROR OR NO KEYBOARD PRESENT :

When it happens, make sure keyboard properly attached and no keys being pressed during booting. If you are purposely configuring the system without a keyboard, enter <ADVANCED CMOS SETUP>and choose <Absent>at the item<System Keyboard>, BIOS will ignore the missing keyboard and continue the booting.

MEMORY ADDRESS ERROR:

While the memory address error revealed, trace the error location with the memory map in system and replace the bad memory chips.

MEMORY SIZE HAS CHANGED:

Memory has been added or removed since the last boot. In EISA mode, re-configure the memory configuration by using Configuration Utility. While in ISA mode, enter Setup and enter the new memory size in the memory fields.

MEMORY VERIFYING ERROR:

It indicates an error verifying value has been written to memory. Use the location along with system's memory map to locate the bad chip.

OFFENDING ADDRESS MISSING:

This is related to the I/O CHANNEL CHECK and RAM PARITY ERROR when the segment cannot be isolated.

REBOOT ERROR:

When error occurs, press any key to reboot the system.

SYSTEM HALTED :

This message indicates the present boot has failed. Press and hold down Ctrl, Alt and Del simultaneously to reboot the system.