



Muffin XL AC - MX2A3 - 028316
 (Family) (Model) (Part Number)

Electrical Specifications

Rated Voltage:	115 VAC
AC Frequency:	60 Hz
Power Supply:	15.0 Watts
Line Current:	0.18 Amps
Locked Rotor Current	0.27 Amps
Nominal Speed:	3100 RPM

Mechanical Specifications

Dimensions:	4.72in x 1.50in
Weight	21.0 oz
Max Airflow @ 0 in H ₂ O	105.0 CFM
Max Pressure @ 0 CFM	0.223 in H ₂ O
Noise	47.6 dBA



Comair Rotron, Inc.
 Phone: 858.348.6200
sales@comairrotron.com

Comair Rotron Europe, Ltd.
 Phone: +44.1527.520525
saleseurope@comairrotron.com

Comair Rotron Fan Company Ltd.
 Phone: +86.21.52260581
salesasia@comairrotron.com

Print Date: Monday, February 18, 2008 at 00:43:14 - AC Fan Datasheet - Web Version 1.0 Rev. A



Mechanical Drawing

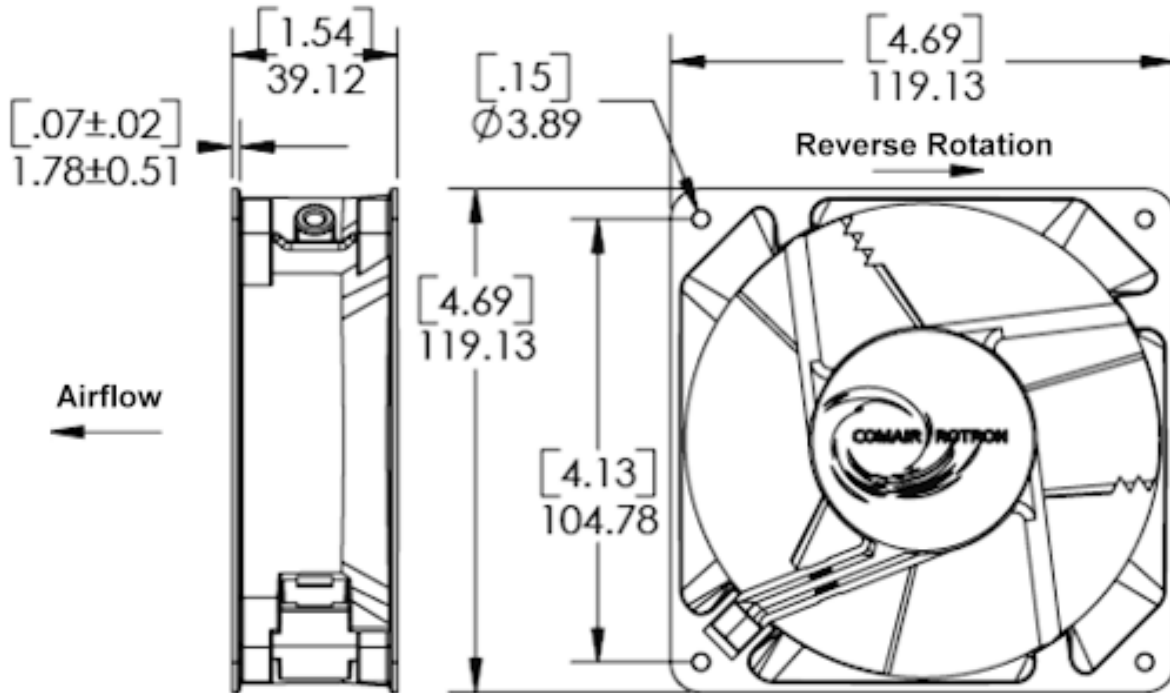

Options

Part Number	Model Number	Bearing Type	Fan Rotation	Termination	In-Stock (Click 'Yes' for current stock)
028420	MX2B1	Ball	Normal	0.120 Terminals	No
030519	MX2B2	Ball	Normal	Leads	No
028422	MX2B3	Ball	Reverse	0.120 Terminals	No
030389	MX2B4	Ball	Reverse	Leads	No
028534	MX2B7	Ball	Reverse	0.187 Terminals	No
028318	MX2A1	Sleeve	Normal	0.120 Terminals	No
030503	MX2A2	Sleeve	Normal	Leads	No
028316	MX2A3	Sleeve	Reverse	0.120 Terminals	No
028476	MX2A4	Sleeve	Reverse	Leads	No
028541	MX2A7	Sleeve	Reverse	0.187 Terminals	No

Accessories (Click on part number for detailed drawing.)

428056
Plug and Cord

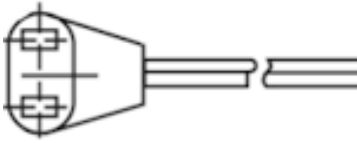

550440
Plug and Cord

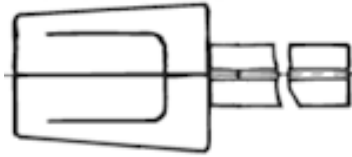

550113
Mounting Clip

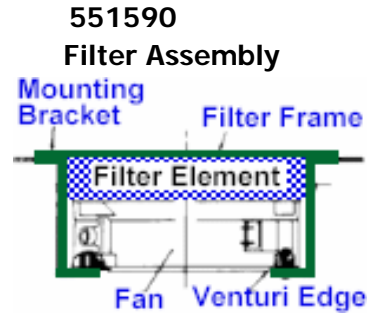
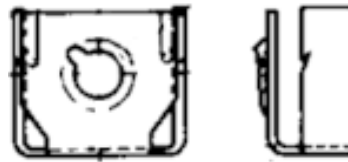

554148
Filter Guard Assembly

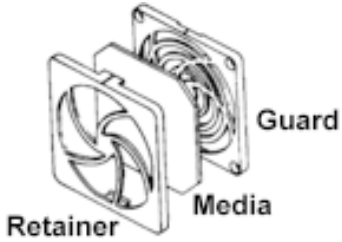

552934
Finger Guard

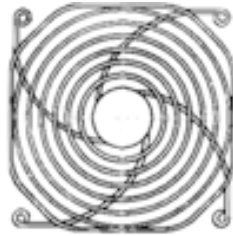

476042
Finger Guard

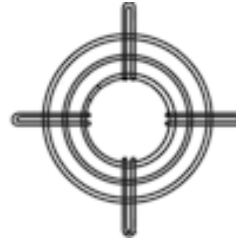

550481
Finger Guard



551147
Finger Guard



Comair Rotron, Inc.
Phone: 858.348.6200
sales@comairrotron.com

Comair Rotron Europe, Ltd.
Phone: +44.1527.520525
saleseurope@comairrotron.com

Comair Rotron Fan Company Ltd.
Phone: +86.21.52260581
salesasia@comairrotron.com