

514 F

DC axial compact fan



ebm-papst St. Georgen GmbH & Co. KG

Hermann-Papst-Straße 1

D-78112 St. Georgen

Phone +49 7724 81-0

Fax +49 7724 81-1309

info2@de.ebmpapst.com

www.ebmpapst.com

Nominal data

Type	514 F	
Nominal voltage	VDC	24
Nominal voltage range	VDC	21.6 .. 26.4
Speed	min ⁻¹	5000
Power input	W	1.0
Min. ambient temperature	°C	-20
Max. ambient temperature	°C	70
Air flow	m ³ /h	20
Sound power level	B	4.5
Sound pressure level	dB(A)	30

ml = max. load · me = max. efficiency · fa = running at free air · cs = customer specs · cu = customer unit
Subject to alterations



Technical features

General description	<p>Particular design features: Compact fan with low power consumption. Some models suitable for use at high ambient temperatures.</p> <p>General features: Material: fibreglass-reinforced plastic. Impeller PA, housing PBT. Electronic commutation completely integrated. Protected against reverse polarity and locking. Connection via single strands AWG 28, TR 64, bared and tin-plated. Air exhaust over bars. Direction of rotation counter-clockwise seen on rotor. Mass: 25 g.</p>
Mass	0.025 kg
Dimensions	50 x 50 x 15 mm
Material of impeller	Fiberglass-reinforced PA plastic
Housing material	Fiberglass-reinforced PBT plastic
Direction of air flow	Air exhaust over bars
Direction of rotation	Left, looking at rotor
Bearing	Sintec sleeve bearing
Lifetime L10 at 20 °C	50000 h
Lifetime L10 at 60 °C	20000 h
Connection line	Single strands AWG 28, TR 64, bared and tin-plated.
Motor protection	Protected against reverse polarity and locking.
Locked-rotor protection	Impedance protection
Approval	VDE, CSA, UL, CE

Product drawing

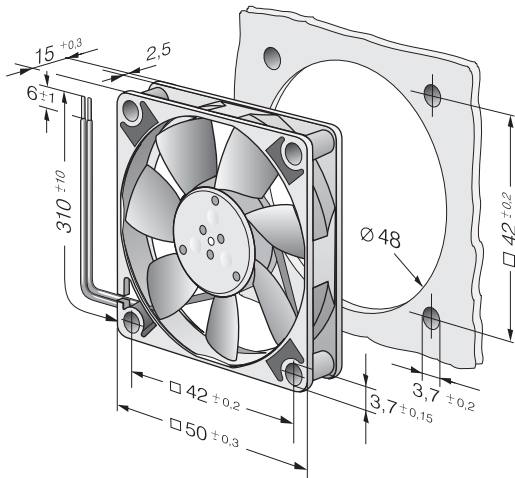

Charts: Air flow

