

# » Kontron User's Guide «

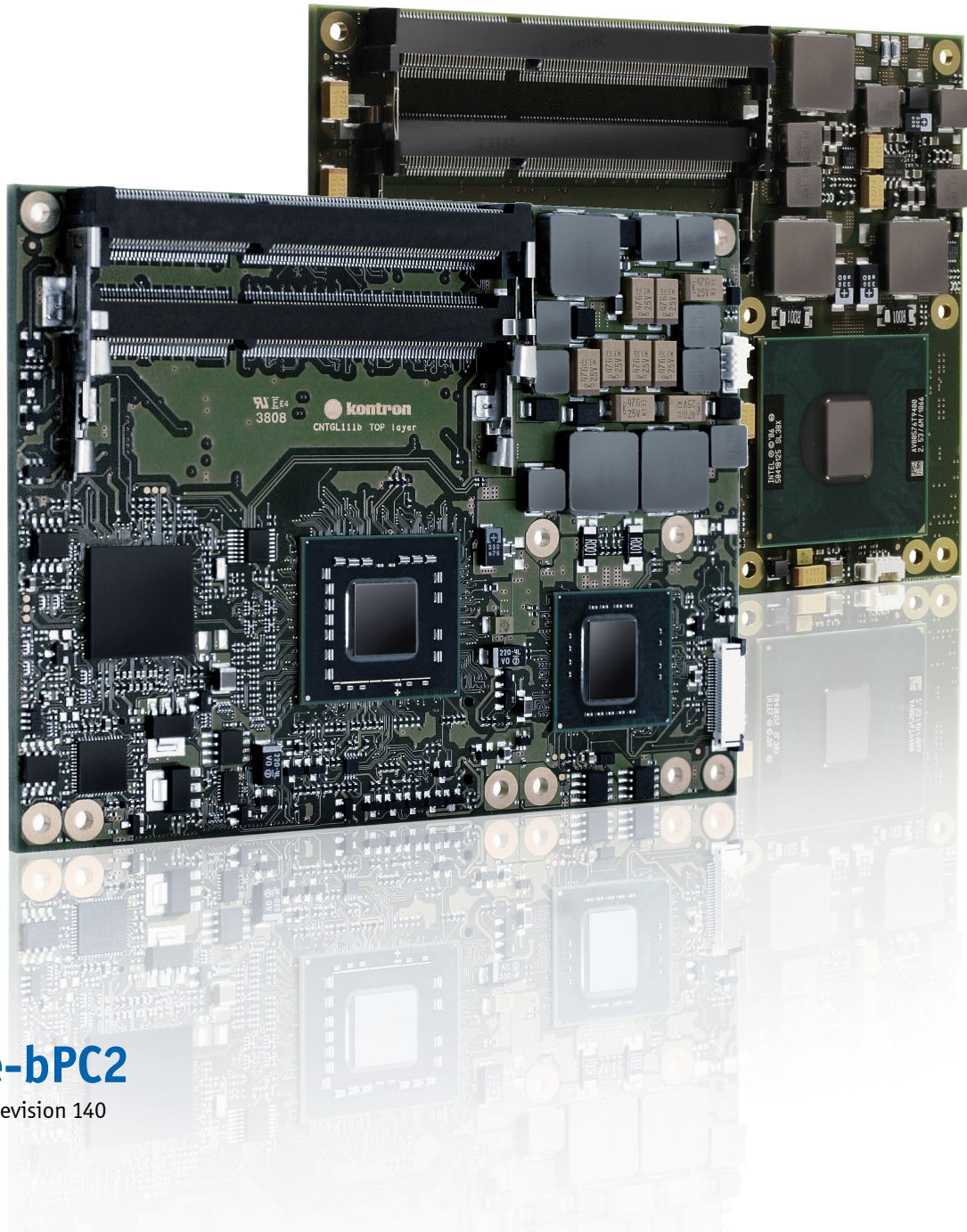

## COMe-bPC2

Document Revision 140



# » Table of Contents «

<b>1</b>	<b><u>User Information</u></b> .....	<b>6</b>
1.1	<u>About This Document</u> .....	6
1.2	<u>Copyright Notice</u> .....	6
1.3	<u>Trademarks</u> .....	6
1.4	<u>Standards</u> .....	6
1.5	<u>Warranty</u> .....	7
1.6	<u>Technical Support</u> .....	7
<b>2</b>	<b><u>Introduction</u></b> .....	<b>8</b>
2.1	<u>Product Description</u> .....	8
2.2	<u>Naming clarification</u> .....	8
2.3	<u>Understanding COM Express® Functionality</u> .....	9
2.4	<u>COM Express® Documentation</u> .....	10
2.5	<u>COM Express® Benefits</u> .....	10
<b>3</b>	<b><u>Product Specification</u></b> .....	<b>11</b>
3.1	<u>Modules &amp; Accessories</u> .....	11
3.2	<u>Functional Specification</u> .....	13
3.3	<u>Block Diagram</u> .....	18
3.4	<u>Electrical Specification</u> .....	19
3.4.1	<u>Supply Voltage</u> .....	19
3.4.2	<u>Power Supply Rise Time</u> .....	19
3.4.3	<u>Supply Voltage Ripple</u> .....	19
3.4.4	<u>Power Consumption</u> .....	19
3.4.5	<u>ATX Mode</u> .....	20
3.4.6	<u>Single Supply Mode</u> .....	20
3.5	<u>Power Control</u> .....	21
3.6	<u>Environmental Specification</u> .....	22
3.6.1	<u>Temperature Specification</u> .....	22
3.6.2	<u>Humidity</u> .....	22
3.7	<u>Standards and Certifications</u> .....	23
3.8	<u>MTBF</u> .....	25
3.9	<u>Mechanical Specification</u> .....	26
3.10	<u>Module Dimensions</u> .....	26
3.10.1	<u>38008-XXXX-XX-X</u> .....	26
3.10.2	<u>38009-XXXX-XX-X</u> .....	27
3.11	<u>Thermal Management</u> .....	28
3.12	<u>Heatspreader</u> .....	28
3.13	<u>Onboard Fan Connector</u> .....	29
3.13.1	<u>BIOS Settings for Fan Control</u> .....	30
3.13.2	<u>Electrical Characteristics</u> .....	30
<b>4</b>	<b><u>Features and Interfaces</u></b> .....	<b>31</b>

4.1	<a href="#">S5 Eco Mode</a> .....	31
4.2	<a href="#">LPC</a> .....	32
4.3	<a href="#">LPC boot</a> .....	33
4.4	<a href="#">M.A.R.S.</a> .....	34
4.5	<a href="#">Fast I2C</a> .....	35
4.6	<a href="#">JIDA16 and JIDA32</a> .....	36
4.7	<a href="#">K-Station 1</a> .....	37
4.8	<a href="#">K-Station &amp; API Resources</a> .....	38
4.8.1	<a href="#">I2C</a> .....	38
4.8.2	<a href="#">Storage</a> .....	38
4.8.3	<a href="#">GPIO</a> .....	38
4.8.4	<a href="#">Hardware Monitor</a> .....	38
4.9	<a href="#">GPIO - General Purpose Input and Output</a> .....	39
4.10	<a href="#">Watchdog Timer</a> .....	40
4.11	<a href="#">Flash Backup Feature</a> .....	41
4.12	<a href="#">Speedstep Technology</a> .....	43
4.13	<a href="#">C-States</a> .....	44
4.14	<a href="#">Dynamic FSB Frequency Switching</a> .....	45
4.15	<a href="#">VID-x</a> .....	46
4.16	<a href="#">Enhanced Intel Dynamic Acceleration Technology</a> .....	47
4.17	<a href="#">Usage of Different Graphic Interfaces</a> .....	48
4.18	<a href="#">Alternative Pin-out of HDMI</a> .....	49
4.19	<a href="#">Alternative Pin-out of Display Port</a> .....	49
4.20	<a href="#">Display Configurations</a> .....	50
4.21	<a href="#">Hybrid Graphics / Multi-monitor</a> .....	52
4.22	<a href="#">Intel® vPro™ technology</a> .....	54
4.23	<a href="#">ACPI Suspend Modes and Resume Events</a> .....	55
<b>5</b>	<b><a href="#">System Ressources</a>.....</b>	<b>56</b>
5.1	<a href="#">Interrupt Request (IRQ) Lines</a> .....	56
5.1.1	<a href="#">In 8259 PIC Mode</a> .....	56
5.1.2	<a href="#">In APIC mode</a> .....	57
5.2	<a href="#">Direct Memory Access (DMA) Channels</a> .....	58
5.3	<a href="#">Memory Area</a> .....	58
5.4	<a href="#">I/O Address Map</a> .....	58
5.5	<a href="#">External Inter-IC (I2C) Bus</a> .....	58
5.6	<a href="#">System Management (SM) Bus</a> .....	58
5.7	<a href="#">JILI I2C Bus</a> .....	58
5.8	<a href="#">SDVO I2C Bus</a> .....	58
5.9	<a href="#">CRT I2C Bus</a> .....	58
<b>6</b>	<b><a href="#">Connectors</a>.....</b>	<b>59</b>
6.1	<a href="#">Connector Location</a> .....	59
<b>7</b>	<b><a href="#">Pinout List</a>.....</b>	<b>60</b>
7.1	<a href="#">General Signal Description</a> .....	60

7.2	<a href="#">Connector X1A Row A</a> .....	61
7.3	<a href="#">Connector X1A Row B</a> .....	63
7.4	<a href="#">Connector X1B Row C</a> .....	65
7.5	<a href="#">Connector X1B Row D</a> .....	67
<b>8</b>	<b><a href="#">BIOS Operation</a>.....</b>	<b>69</b>
8.1	<a href="#">Determining the BIOS Version</a> .....	69
8.2	<a href="#">BIOS Update</a> .....	69
8.3	<a href="#">Setup Guide</a> .....	70
8.3.1	<a href="#">Start AMI® BIOS Setup Utility</a> .....	70
8.4	<a href="#">BIOS Setup</a> .....	72
8.4.1	<a href="#">Main Menu</a> .....	72
8.4.2	<a href="#">Module Info</a> .....	73
8.4.3	<a href="#">Advanced Menu</a> .....	76
8.4.4	<a href="#">PCI/PnP Menu</a> .....	104
8.4.5	<a href="#">Boot</a> .....	105
8.4.6	<a href="#">Security</a> .....	107
8.4.7	<a href="#">Chipset</a> .....	108
8.4.8	<a href="#">Exit Menu</a> .....	114

# 1 User Information

## 1.1 About This Document

This document provides information about products from Kontron Europe GmbH and/or its subsidiaries. No warranty of suitability, purpose, or fitness is implied. While every attempt has been made to ensure that the information in this document is accurate, the information contained within is supplied "as-is" and is subject to change without notice.

For the circuits, descriptions and tables indicated, Kontron assumes no responsibility as far as patents or other rights of third parties are concerned.

## 1.2 Copyright Notice

Copyright © 2003-2012 Kontron Europe GmbH

All rights reserved. No part of this document may be reproduced, transmitted, transcribed, stored in a retrieval system, or translated into any language or computer language, in any form or by any means (electronic, mechanical, photocopying, recording, or otherwise), without the express written permission of Kontron Europe GmbH.

DIMM-PC®, PISA®, ETX®, ETXexpress®, microETXexpress®, X-board®, DIMM-IO® and DIMM-BUS® are trademarks or registered trademarks of Kontron Europe GmbH. Kontron is trademark or registered trademark of Kontron AG.

## 1.3 Trademarks

The following lists the trademarks of components used in this board.

- » IBM, XT, AT, PS/2 and Personal System/2 are trademarks of International Business Machines Corp.
- » Microsoft is a registered trademark of Microsoft Corp.
- » Intel is a registered trademark of Intel Corp.
- » All other products and trademarks mentioned in this manual are trademarks of their respective owners.

## 1.4 Standards

Kontron Europe GmbH is certified to ISO 9000 standards.

## 1.5 Warranty

This Kontron Europe GmbH product is warranted against defects in material and workmanship for the warranty period from the date of shipment. During the warranty period, Kontron Europe GmbH will at its discretion decide to repair or replace defective products.

Within the warranty period, the repair of products is free of charge as long as warranty conditions are observed.

The warranty does not apply to defects resulting from improper or inadequate maintenance or handling by the buyer, unauthorized modification or misuse, operation outside of the product's environmental specifications or improper installation or maintenance.

Kontron Europe GmbH will not be responsible for any defects or damages to other products not supplied by Kontron Europe GmbH that are caused by a faulty Kontron Europe GmbH product.

## 1.6 Technical Support

Technicians and engineers from Kontron Europe GmbH and/or its subsidiaries are available for technical support. We are committed to making our product easy to use and will help you use our products in your systems.

Please consult our Web site at <http://www.kontron.com/support> for the latest product documentation, utilities, drivers and support contacts. Consult our customer section <http://emdcustomersection.kontron.com> for the latest BIOS downloads, Product Change Notifications, Board Support Packages, DemoImages, 3D drawings and additional tools and software. In any case you can always contact your board supplier for technical support.

## 2 Introduction

### 2.1 Product Description

The COMe-bPC2 module unifies the 45 nm generations of Intel® Core™ 2 Duo processors with the new SSE4 instruction set and the chipset Intel® GS45, GM45 and GL40. This combination really sets new standards in many terms: more performance than ever on COM Express® form factor, outstanding performance-power-ratio, fast DDR3 SO-DIMM memory up to 8 GB and L2 cache up to 6 MB, the module really opens up new application fields.

COMe-bPC2 is available with Intel® small form factor package: for instance, the ICH9M was shrunk from 961 mm<sup>2</sup> to 256 mm<sup>2</sup>. Thus, valuable space for further features is gained: among others two stacked SO-DIMM sockets for dual channel memory. On top of that, Intel® small form factor package processors allow operations in ultra low voltage for best energy-efficiency. The bigger Intel® Performance Package offer high performance for bargain pricing.

Especially, its 4 Serial ATA ports and the native RAID support establishes the COMe-bPC2 perfectly for heavy data sensitive applications. On top of all that, DirectX® 10 supports Windows® perfectly.

Like all KontronCOM Express® modules, it is strictly compliant to the COM Express® standard. Therefore, upgrading existing carrier boards gets so easy and minimizes redesign efforts.

### 2.2 Naming clarification

COM Express® defines a Computer-On-Module, or COM, with all components necessary for a bootable host computer, packaged as a super component.

» COMe-bXX# modules are Kontron's COM Express® modules in basic form factor (125mm x 95mm), formerly known as ETXexpress®

» COMe-cXX# modules are Kontron's COM Express® modules in compact form factor (95mm x 95mm), formerly known as microETXexpress®

» COMe-mXX# modules are Kontron's COM Express® modules in mini form factor (55mm x 84mm), formerly known as nanoETXexpress

The product names for Kontron COM Express® Computer-on-Modules consist of a short form of the industry standard (**COMe-**), the form factor (**b**=basic, **c**=compact, **m**=mini), the capital letters for the CPU and Chipset Codenames (**XX**) and the pin-out type (**#**) followed by the CPU Name.



## 2.3 Understanding COM Express® Functionality

All Kontron COM Express® basic and compact modules contain two 220pin connectors; each of it has two rows called Row A & B on primary connector and Row C & D on secondary connector. COM Express® Computer-on-modules feature the following maximum amount of interfaces according to the PICMG module Pin-out type:

Feature	Pin-Out Type 1	Pin-Out Type 10	Pin-Out Type 2	Pin-Out Type 6
HD Audio	1x	1x	1x	1x
Gbit Ethernet	1x	1x	1x	1x
Serial ATA	4x	4x	4x	4x
Parallel ATA	-	-	1x	-
PCI	-	-	1x	-
PCI Express x1	6x	6x	6x	8x
PCI Express x16 (PEG)	-	-	1x	1x
USB Client	1x	1x	-	-
USB 2.0	8x	8x	8x	8x
USB 3.0	-	2x	-	4x
VGA	1x	-	1x	1x
LVDS	Dual Channel	Single Channel	Dual Channel	Dual Channel
DP++ (SDVO/DP/HDMI/DVI)	1x optional	1x	3x shared with PEG	3x
LPC	1x	1x	1x	1x
External SMB	1x	1x	1x	1x
External I2C	1x	1x	1x	1x
GPIO	8x	8x	8x	8x
SDIO	1x optional	1x optional	-	-
UART (2-wire COM)	-	2x	-	2x
FAN PWM out	-	1x	-	1x

## 2.4 COM Express® Documentation

This product manual serves as one of three principal references for a COM Express® design. It documents the specifications and features of COMe-bPC2. Additional references are available from your Kontron Support or from PICMG®:

- » The COM Express® Specification defines the COM Express® module form factor, pin-out, and signals. This document is available from the PICMG website by filling out the order form.
- » The COM Express® Design Guide by PICMG serves as a general guide for baseboard design, with a focus on maximum flexibility to accommodate a wide range of COM Express® modules.



Some of the information contained within this product manual applies only to certain product revisions (CE: xxx). If certain information applies to specific product revisions (CE: xxx) it will be stated. Please check the product revision of your module to see if this information is applicable.

## 2.5 COM Express® Benefits

COM Express® modules are very compact, highly integrated computers. All Kontron COM Express® modules feature a standardized form factor and a standardized connector layout that carry a specified set of signals. Each COM is based on the COM Express® specification. This standardization allows designers to create a single-system baseboard that can accept present and future COM Express® modules.

The baseboard designer can optimize exactly how each of these functions implements physically. Designers can place connectors precisely where needed for the application on a baseboard designed to optimally fit a system's packaging.

A single baseboard design can use a range of COM Express® modules with different size and pin-out. This flexibility can differentiate products at various price/performance points, or to design future proof systems that have a built-in upgrade path. The modularity of a COM Express® solution also ensures against obsolescence as computer technology evolves. A properly designed COM Express® baseboard can work with several successive generations of COM Express® modules.

A COM Express® baseboard design has many advantages of a custom, computer-board design but delivers better obsolescence protection, greatly reduced engineering effort, and faster time to market.

## 3 Product Specification

### 3.1 Modules & Accessories

The COM Express® basic sized Computer-on-Module COMe-bPC2 (Internal project code CNTG / CNT2 / CNTX) follows pin-out Type 2 and is compatible to PICMG specification COM.0 Rev 1.0. The COMe-bPC2, based on Intel's Montevina platform is available in different variants to cover the demand of different performance, price and power:

#### Commercial grade modules (0°C to 60°C operating)

Product Number	Product Name	Processor	Socket	GMCH	IOH
38009-0000-25-2	COMe-bPC2 T9400	Intel® Core™2 Duo T9400	BGA479	GM45	ICH9EM
38009-0000-23-2	COMe-bPC2 P8400	Intel® Core™2 Duo P8400	BGA479	GM45	ICH9EM
38009-0000-19-0	COMe-bPC2 T3100	Intel® Core™2 Duo T3100	PGA478	GL40	ICH9M
38009-0000-20-0	COMe-bPC2 CM575	Intel® Celeron® 575	PGA478	GL40	ICH9M
38008-0000-23-2	COMe-bPC2 SP9300	Intel® Core™2 Duo SP9300	BGA956	GS45	ICH9M-SFF
38008-0000-19-2	COMe-bPC2 SL9400	Intel® Core™2 Duo SL9400	BGA956	GS45	ICH9M-SFF
38008-0000-12-2	COMe-bPC2 SU9300	Intel® Core™2 Duo SU9300	BGA956	GS45	ICH9M-SFF
38008-0000-12-3	COMe-bPC2 CM723	Intel® Celeron®M ULV 723	BGA956	GS45	ICH9M-SFF
38008-0000-12-1	COMe-bPC2 CM722	Intel® Celeron®M ULV 722	BGA956	GS45	ICH9M-SFF

#### Extended temperature modules (E1, -25°C to 75°C operating)

Product Number	Product Name	Processor	Socket	GMCH	IOH
38008-0000-19-2EXT	COMe-bPC2 SL9400 E1	Intel® Core™2 Duo SL9400	BGA956	GS45	ICH9M-SFF

#### Industrial grade modules (E2, -40°C to 85°C operating)

Product Number	Product Name	Processor	Socket	GMCH	IOH
38011-0000-19-2	COMe-bPC2 SL9400 XT	Intel® Core™2 Duo SL9400	BGA956	GS45	ICH9M-SFF
38011-0000-12-2	COMe-bPC2 SU9300 XT	Intel® Core™2 Duo SU9300	BGA956	GS45	ICH9M-SFF
38011-0000-12-1	COMe-bPC2 CM722 XT	Intel® Celeron®M ULV 722	BGA956	GS45	ICH9M-SFF

## Accessories

Product Number	Carrier Boards
38102-0000-00-1	COM Express® Reference Carrier Type 2 (8mm COMe connector)
38104-0000-00-0	COM Express® Eval Carrier Type 2 (Niles Canyon, 5mm COMe connector)
38104-0000-00-1	COM Express® Eval Carrier Type 2 (Topanga Canyon, 5mm COMe connector)
Product Number	Memory
97015-1024-10-0	DDR3-1066 SODIMM 1GB
97015-2048-10-0	DDR3-1066 SODIMM 2GB
97015-4096-10-0	DDR3-1066 SODIMM 4GB
97015-1024-10-2	DDR3-1066 SODIMM 1GB E2
97015-2048-10-2	DDR3-1066 SODIMM 2GB E2
97015-4096-10-2	DDR3-1066 SODIMM 4GB E2
Product Number	Cooling & Mounting
38009-0000-99-0	HSP COMe-bPC2 GM45 thread
38009-0000-99-1	HSP COMe-bPC2 GM45 through
38009-0000-99-2	HSP COMe-bPC2 GL40 thread
38009-0000-99-3	HSP COMe-bPC2 GL40 through
38009-0000-99-0C05	HSK COMe-bPC2 GM45 act. setscrew thread
38009-0000-99-0C06	HSK COMe-bPC2 GM45 pas. setscrew thread
38008-0000-99-0	HSP COMe-bPC2 GS45 thread
38008-0000-99-1	HSP COMe-bPC2 GS45 through
38008-0000-99-0C05	HSK COMe-bPC2 GS45 act. setscrew thread
38008-0000-99-0C06	HSK COMe-bPC2 GS45 pas. setscrew thread
36099-0000-99-0	COMe Active Uni Cooler (for CPUs up to 20W TDP)
36099-0000-99-1	COMe Passive Uni Cooler (for CPUs up to 10W TDP)
38017-0000-00-0	COMe Mount KIT 8mm 1set
38017-0000-00-5	COMe Mount KIT 5mm 1set
38017-0100-00-5	COMe Mount KIT 5mm 100sets
38017-0100-00-0	COMe Mount Kit 8mm 100sets
Product Number	Adapter & Cables
9-5000-0352	ADA-LVDS-DVI 18bit (LVDS to DVI converter)
9-5000-0353	ADA-LVDS-DVI 24bit (LVDS to DVI converter)
96006-0000-00-7	ADA-Type2-DP3 (Adapter Card Type 2 module to 3x DisplayPort)
96006-0000-00-8	ADA-DP-LVDS (DP to LVDS adapter)
96082-0000-00-0	KAB-ADAPT-DP-DVI (DP to DVI adapter cable)
96083-0000-00-0	KAB-ADAPT-DP-VGA (DP to VGA adapter cable)
96084-0000-00-0	KAB-ADAPT-DP-HDMI (DP to HDMI adapter cable)
96079-0000-00-0	KAB-HSP 200mm (Cable adapter to connect FAN to module)
96079-0000-00-2	KAB-HSP 40mm (Cable adapter to connect FAN to module)

## 3.2 Functional Specification

### Processor

The Intel® Core™2 Duo / Celeron® (Penryn) CPU family supports:

- » Intel® Dynamic Acceleration (Turbo Mode)
- » Intel® Virtualization Technology (VT-x)
- » Intel® Trusted Execution Technology (TXT)
- » Intel® 64
- » Idle States
- » Enhanced Intel SpeedStep® Technology
- » Execute Disable Bit
- » Intel® Dynamic FSB Frequency Switching (SuperLFM)
- » Thermal Monitoring Technologies

### CPU specifications

Processor	Cores	Core	CPU Clock	Turbo	L2 Cache	C-States	FSB Speed	VT-x	TXT	Intel® 64	EIST
Intel® Celeron® M722	1	45nm	1200MHz	-	1MB	C0 - C3	800 MHz	No	No	Yes	No
Intel® Celeron® M723	1	45nm	1200MHz	-	1MB	C0 - C3	800 MHz	No	No	Yes	No
Intel® Core™2 Duo SU9300	2	45nm	1200MHz	1400MHz	3MB	C0 - C6	800 MHz	Yes	Yes	Yes	Yes
Intel® Core™2 Duo SL9400	2	45nm	1866MHz	2000MHz	6MB	C0 - C6	1066 MHz	Yes	Yes	Yes	Yes
Intel® Core™2 Duo SP9300	2	45nm	2266MHz	2400MHz	6MB	C0 - C6	1066 MHz	Yes	Yes	Yes	Yes
Intel® Celeron® 575	1	65nm	2000MHz	-	1MB	C0 - C3	667 MHz	No	No	Yes	No
Intel® Celeron® T3100	2	45nm	1900MHz	-	1MB	C0 - C4	800 MHz	No	No	Yes	No
Intel® Core™2 Duo P8400	2	45nm	2266MHz	2400MHz	3MB	C0 - C6	1066 MHz	Yes	Yes	Yes	Yes
Intel® Core™2 Duo T9400	2	45nm	2400MHz	2533MHz	6MB	C0 - C6	1066 MHz	Yes	Yes	Yes	Yes

45nm: Penryn Core, 65nm: Merom Core

## Chipset

The Intel Gen4 Graphics and Memory Controller Hub Cantiga supports:

- » PCI Express Revision 1.1
- » Intel® Virtualization Technology for Directed I/O (VT-d)
- » Intel® Trusted Execution Technology
- » Intel® Active Management Technology 4.0
- » Intel® ICH9 family IO Controller

## GMCH and IOH specifications

Feature	GS45/ICH9M-SFF	GM45/ICH9EM	GL40/ICH9M
TDP	12W + 2.5W	12W + 2.5W	12W + 2.5W
Max Memory	8GB	8GB	4GB
Memory Type	DDR3-1066	DDR3-1066	DDR3-800
FSB	800/1066MHz	667/800/1066MHz	667MHz
PCIe x16 (PEG)	YES	YES	NO
VT-d	YES	YES	NO
AMT	YES	YES	NO
iTPM	YES	YES	NO
SATA RAID	0,1	0,1,Matrix	-



The Intel® Trusted Execution Technology (TXT) and Active Management Technology (AMT) are not supported by default on COMe-bPC2. Please contact your local sales or support.

## Memory

Sockets	2x DDR3 SO-DIMM
Memory Type	DDR3-667/800/1066
Maximum Size	8GB (GL40: 4GB)
Technology	Dual Channel



Only use non-ECC DDR3 memory modules. Kontron Part.No: 97015-xxxx-xx-x. If only one RAM module is used, it must be plugged into the lower socket if it is a board with GS45. On modules with GM45 or GL40 chipset a single RAM module must be plugged in the upper RAM socket. Otherwise there might be issues with the management engine, which lead to several problems.

## Graphics Core

The integrated Intel® GMA X4500MHD (Gen5.5) supports:

Graphics Core Render Clock	GS45: 533/320MHz, GM45: 533MHz GL40: 400MHz
Execution Units / Pixel Pipelines	10
Max Graphics Memory	1720MB
GFX Memory Bandwidth (GB/s)	GS45/GM45: 17, GL40: 12.8
GFX Memory Technology	DVMT 5.0
API (DirectX/OpenGL)	10 / 2.1
Shader Model	4.0
Hardware accelerated Video	MPEG2, VC-1, AVC, Blu-Ray
Independent/Simultaneous Displays	2
Display Port	YES
HDCP support	HDCP 1.2 (Keys optional)

## Monitor output

CRT max Resolution	2048x1536
TV out:	YES

## LVDS

LVDS Bits/Pixel	1x18 / 2x18
LVDS Bits/Pixel with dithering	1x24 / 2x24
LVDS max Resolution:	1600x1200
PWM Backlight Control:	YES
Supported Panel Data:	JILI2/JILI3/EDID/DID

## Display Interfaces

Discrete Graphics	1x PEG 1.0 (not with GL40)
Digital Display Interface DDI1	DP++/SDVOB
Digital Display Interface DDI2	DP++/SDVOC
Digital Display Interface DDI3	DP++
Maximum Resolution on DDI	2560x1600



The discrete PEG graphics port and the digital display interfaces are multiplexed and cannot be used simultaneously. Display Port plus plus (DP++) allows usage as DisplayPort, HDMI or DVI

## PEG Configuration

The x16 PCI Express Graphics Port (PEG) is compatible to standard PCI Express devices like Ethernet or RAID controllers. The COMe-bPC2 supports following PEG Port configuration when used as PCI Express Interface:

- » 1x16
- » 1x1

## Storage

onboard SSD	-
SD Card support	-
IDE Interface	ETXe-PC: JM20335 USB2IDE / ETEXe-PC-XT: JMD330 SATA2PATA
Serial-ATA	4x SATA 3Gb/s
SATA AHCI	NCQ, HotPlug, Staggered Spinup, eSATA, PortMultiplier
SATA RAID	0, 1, MATRIX (ICH9M: no RAID)

## Connectivity

USB	8x USB 2.0
USB Client	-
PCI	PCI Rev 2.3 (33MHz/3.3V)
PCI External Masters	4
PCI Express	5x PCIe x1 Gen1
Max PCI Express	6x PCIe x1 without LAN
PCI Express x2/x4 configuration	YES (external HW strap option)
Ethernet	10/100/1000 Mbit
Ethernet controller	Intel® 82567 (Boazman)

It is also possible to run the 1st 4 x1 lanes as 1 x4 lane. For that please pull-up the signal A33 and A29 to 3.3V on the baseboard.



Express Card hotplug functionality is only available, when in BIOS setup the PCIexpress lane is switched from [AUTO] which is default setting to [ENABLED]

## Ethernet

The Intel® 82567 (Boazman) ethernet supports:

- » Jumbo Frames
- » MACsec IEEE 802.1 AE
- » WOL (Wake On LAN)
- » PXE (Preboot eXecution Environment)

## Misc Interfaces and Features

Audio	HD Audio
Onboard Hardware Monitor	ON Semi ADT7475
Trusted Platform Module	iTPM 1.2 (int. in ICH9M-SFF/M-E)
Miscellaneous	-



Baseboards with AC'97 codec only are not supported.

## Kontron Features

External I2C Bus	Fast I2C
M.A.R.S. support	YES
Embedded API	JIDA16 / JIDA32 / PICMG EAPI
Custom BIOS Settings / Flash Backup	YES
Watchdog support	Single Staged



## Power Features

Singly Supply Support	YES
Supply Voltage	8.5V - 18V
ACPI	ACPI 3.0
S-States	S0, S3, S4, S5
S5 Eco Mode	YES
Misc Power Management	DPST 4.0

## Power Consumption and Performance

Full Load Power Consumption	13 - 50W
Kontron Performance Index	2942 - 6347
Kontron Performance/Watt	124 - 225



Detailed Power Consumption measurements in all states and benchmarks for CPU, Graphics and Memory performance are available in Application Note [KEMAP054](#) at [EMD Customer Section](#).

## Supported Operating Systems

The COMe-bPC2 supports:

- » Microsoft Windows XP x86/x64
- » Microsoft Windows Vista x86/x64
- » Microsoft Windows 7 x86/x64
- » Microsoft Windows CE 6.0
- » Microsoft Windows XP embedded
- » Linux
- » WindRiver VxWorks
- » QNX Neutrino 6.5

### 3.3 Block Diagram

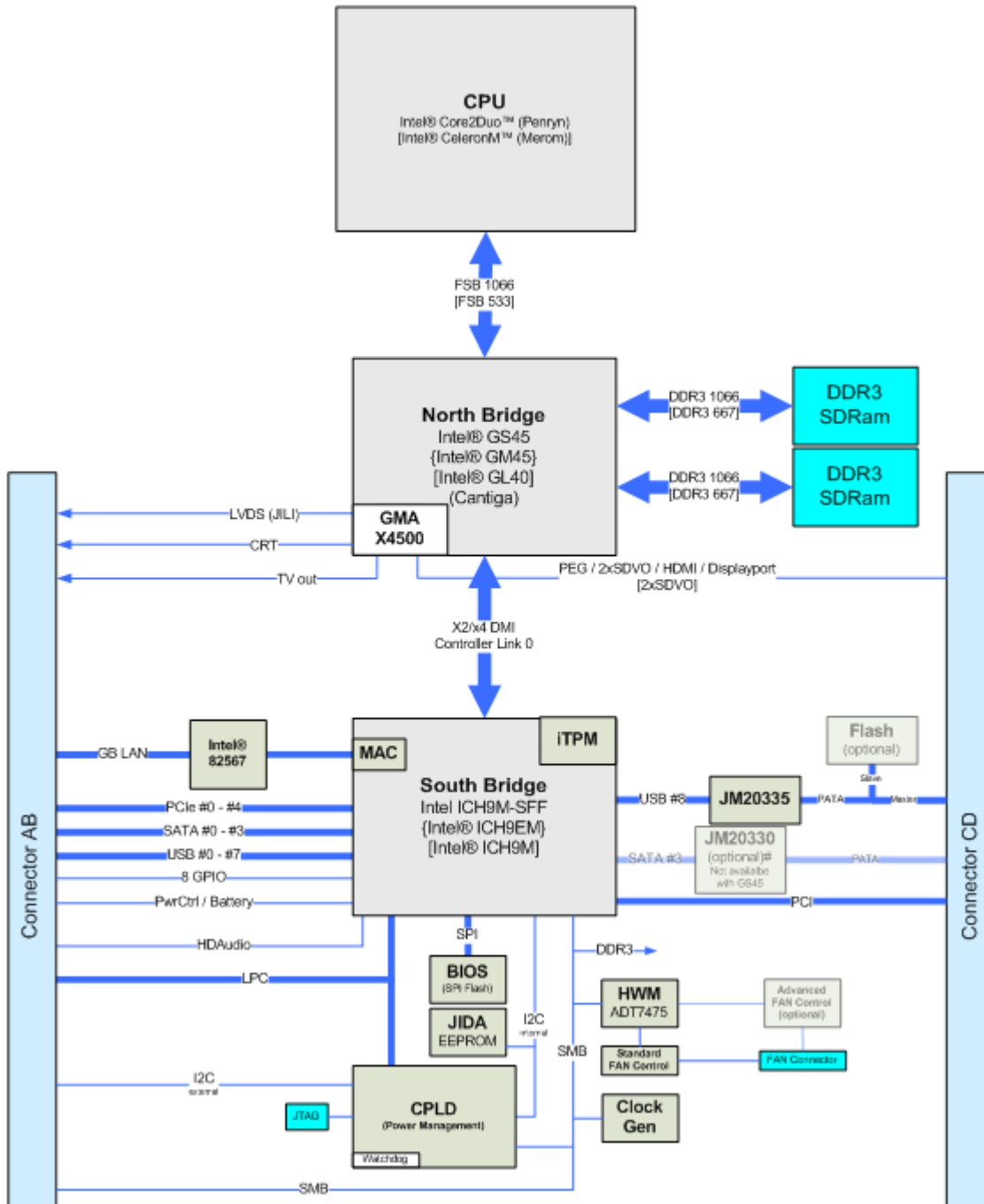

## 3.4 Electrical Specification

### 3.4.1 Supply Voltage

Following supply voltage is specified at the COM Express® connector:

VCC:	8.5V - 18V
Standby:	5V DC +/- 5%
RTC:	2.5V - 3.3V



- 5V Standby voltage is not mandatory for operation.
- Extended Temperature (E1) variants are validated for 12V supply only

### 3.4.2 Power Supply Rise Time

- » The input voltages shall rise from  $\leq 10\%$  of nominal to within the regulation ranges within 0.1ms to 20ms.
- » There must be a smooth and continuous ramp of each DC input voltage from 10% to 90% of its final set-point following the ATX specification

### 3.4.3 Supply Voltage Ripple

- » Maximum 100 mV peak to peak 0 – 20 MHz

### 3.4.4 Power Consumption

The maximum Power Consumption of the different COMe-bPC2 variants is 13 - 50W (100% CPU load on all cores; 90°C CPU temperature). Further information with detailed measurements are available in Application Note KEMAP054 available on [EMD Customer Section](#). Information there is available after registration.

### 3.4.5 ATX Mode

By connecting an ATX power supply with VCC and 5VSB, PWR\_OK is set to low level and VCC is off. Press the Power Button to enable the ATX PSU setting PWR\_OK to high level and powering on VCC. The ATX PSU is controlled by the PS\_ON# signal which is generated by SUS\_S3# via inversion. VCC can be 8.5V - 18V in ATX Mode. On Computer-on-Modules supporting a wide range input down to 4.75V the input voltage shall always be higher than 5V Standby (VCC > 5VSB).

State	PWRBTN#	PWR_OK	V5_StdBy	PS_ON#	VCC
G3	x	x	0V	x	0V
S5	high	low	5V	high	0V
S5 → S0	PWRBTN Event	low → high	5V	high → low	0 V → VCC
S0	high	high	5V	low	VCC

### 3.4.6 Single Supply Mode

In single supply mode (or automatic power on after power loss) without 5V Standby the module will start automatically when VCC power is connected and Power Good input is open or at high level (internal PU to 3.3V). PS\_ON# is not used in this mode and VCC can be 8.5V - 18V.

To power on the module from S5 state press the power button or reconnect VCC. Suspend/Standby States are not supported in Single Supply Mode.

State	PWRBTN#	PWR_OK	V5_StdBy	VCC
G3	x	x	x	0
G3 → S0	high	open / high	x	connecting VCC
S5	high	open / high	x	VCC
S5 → S0	PWRBTN Event	open / high	x	reconnecting VCC



Signals marked with “x” are not important for the specific power state. There is no difference if connected or open.

All ground pins have to be tied to the ground plane of the carrier board.

## 3.5 Power Control

### Power Supply

The COMe-bPC2 supports a power input from 8.5V - 18V. The supply voltage is applied through the VCC pins (VCC) of the module connector.

### Power Button (PWRBTN#)

The power button (Pin B12) is available through the module connector described in the pinout list. To start the module via Power Button the PWRBTN# signal must be at least 50ms ( $50\text{ms} \leq t < 4\text{s}$ , typical 400ms) at low level (Power Button Event).

Pressing the power button for at least 4seconds will turn off power to the module (Power Button Override).

### Power Good (PWR\_OK)

The COMe-bPC2 provides an external input for a power-good signal (Pin B24). The implementation of this subsystem complies with the COM Express® Specification. PWR\_OK is internally pulled up to 3.3V and must be high level to power on the module.

### Reset Button (SYS\_RESET#)

The reset button (Pin B49) is available through the module connector described in the pinout list. The module will stay in reset as long as SYS\_RESET# is grounded. If available, the BIOS setting for "Reset Behavior" must be set to "Power Cycle".



Modules with Intel® Chipset and active Management Engine does not allow to hold the module in Reset out of S0 for a long time. At about 10s holding the reset button the ME will reboot the module automatically

### SM-Bus Alert (SMB\_ALERT#)

With an external battery manager present and SMB\_ALERT# (Pin B15) connected the module always powers on even if BIOS switch "After Power Fail" is set to "Stay Off".

## 3.6 Environmental Specification

### 3.6.1 Temperature Specification

General Specification	Operating	Non-operating
Commercial grade	0°C to +60°C	-30°C to +85°C
Extended (E1)	-25°C to +75°C	-30°C to +85°C
Industrial grade (E2)	-40°C to +85°C	-40°C to +85°C



Standard modules are available for commercial grade temperature range. Please see chapter Product Specification for available variants for extended or industrial temperate grade

#### With Kontron heatspreader plate assembly

The operating temperature defines two requirements:

- » the maximum ambient temperature with ambient being the air surrounding the module.
- » the maximum measurable temperature on any spot on the heatspreader's surface

#### Without Kontron heatspreader plate assembly

The operating temperature is the maximum measurable temperature on any spot on the module's surface.

### 3.6.2 Humidity

- » Operating: 10% to 90% (non condensing)
- » Non operating: 5% to 95% (non condensing)

## 3.7 Standards and Certifications

### RoHS

The **COMe-bPC2** is compliant to the directive 2002/95/EC on the restriction of the use of certain hazardous substances (RoHS) in electrical and electronic equipment.



### CE marking

The **COMe-bPC2** is CE marked according to Low Voltage Directive 2006/95/EC – Test standard EN60950



### Component Recognition UL 60950-1

The **COM Express® basic** form factor Computer-on-Modules are Recognized by Underwriters Laboratories Inc. Representative samples of this component have been evaluated by UL and meet applicable UL requirements.

UL Listings:

» [NWGQ2.E304278](#)

» [NWGQ8.E304278](#)



### WEEE Directive

WEEE Directive 2002/96/EC is not applicable for Computer-on-Modules.

### Conformal Coating

Conformal Coating is available for Kontron Computer-on-Modules and for validated SO-DIMM memory modules. Please contact your local sales or support for further details.

## Shock & Vibration

The **COM Express® basic** form factor Computer-on-Modules successfully passed shock and vibration tests according to

- » IEC/EN 60068-2-6 (Non operating Vibration, sinusoidal, 10Hz-4000Hz, +/-0.15mm, 2g)
- » IEC/EN 60068-2-27 (Non operating Shock Test, half-sinusoidal, 11ms, 15g)

## EMC

Validated in Kontron reference housing for EMC the **COMe-bPC2** follows the requirements for electromagnetic compatibility standards

- » EN55022
- » EN55011
- » EN55024
- » FCC15



### 3.8 MTBF

The following MTBF (Mean Time Before Failure) values were calculated using a combination of manufacturer's test data, if the data was available, and the Telcordia (Bellcore) issue 2 calculation for the remaining parts.

The calculation method used is "Telcordia Method 1 Case 3" in a ground benign, controlled environment (GB,GC). This particular method takes into account varying temperature and stress data and the system is assumed to have not been burned in.

Other environmental stresses (extreme altitude, vibration, salt water exposure, etc) lower MTBF values.

System MTBF (hours):      GS45 variant: 166409 @ 40°C  
   GM45 variant: 166443 @ 40°C  
   XT variant: 184428 @ 40°C



Fans usually shipped with Kontron Europe GmbH products have 50,000-hour typical operating life. The above estimates assume no fan, but a passive heat sinking arrangement. Estimated RTC battery life (as opposed to battery failures) is not accounted for in the above figures and need to be considered for separately. Battery life depends on both temperature and operating conditions. When the Kontron unit has external power; the only battery drain is from leakage paths.

## 3.9 Mechanical Specification

### Dimension

- » 95.0 mm x 125.0 mm
- » Hight approx. 12mm (0.4")



CAD drawings are available at [EMD CustomerSection](#)

## 3.10 Module Dimensions

### 3.10.1 38008-XXXX-XX-X

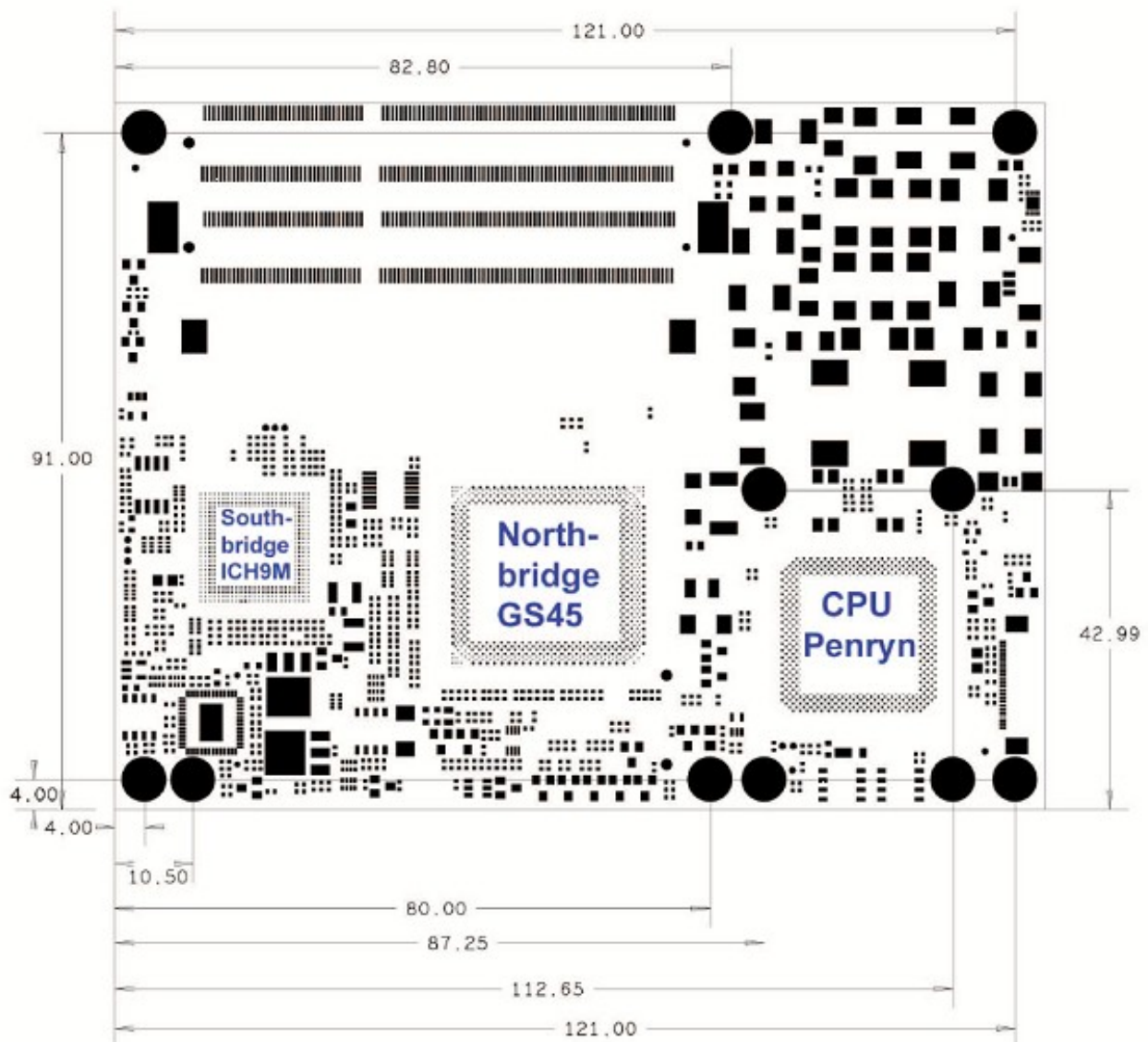

## 3.10.2 38009-XXXX-XX-X

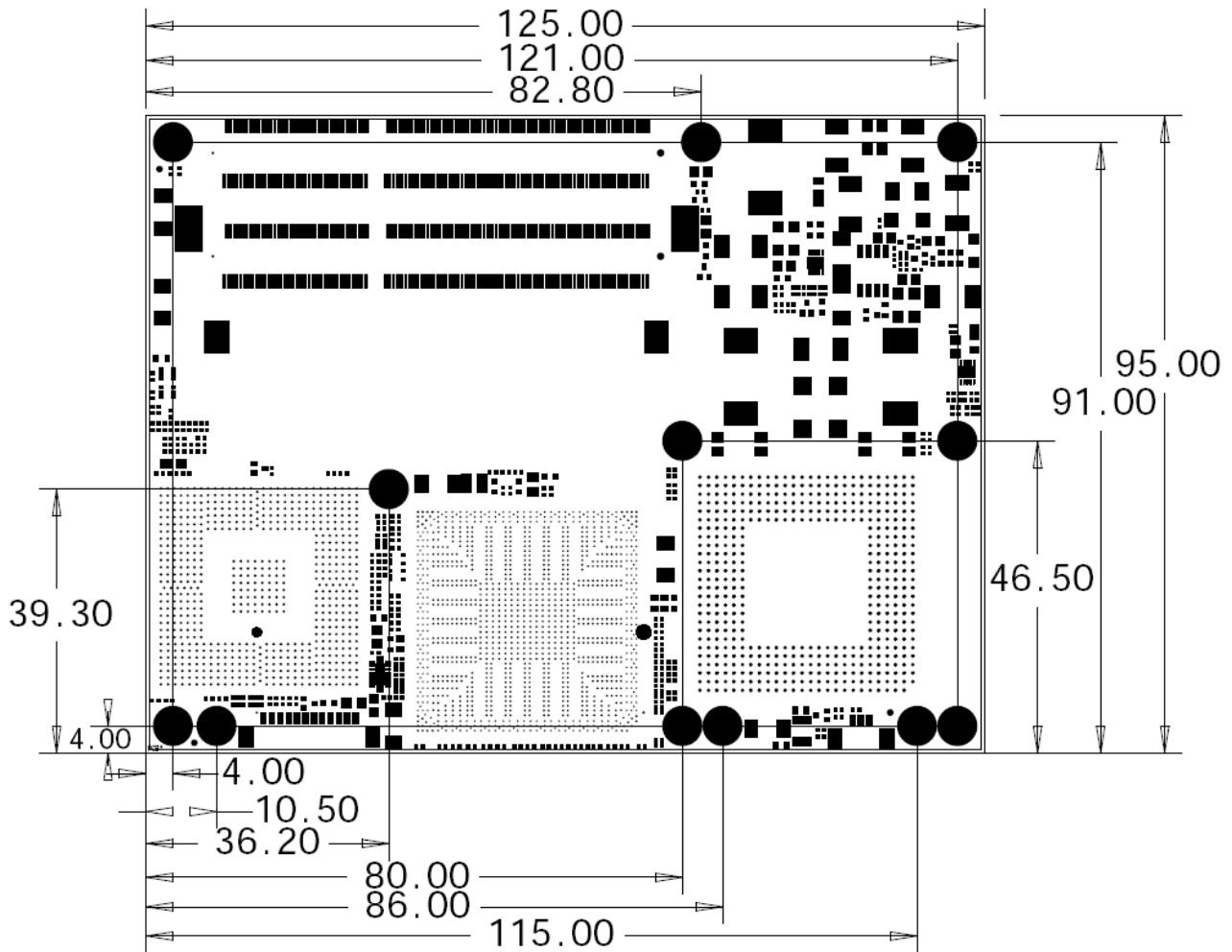

### 3.11 Thermal Management

A heatspreader plate assembly is available from Kontron Europe GmbH for the COMe-bPC2. The heatspreader plate on top of this assembly is NOT a heat sink. It works as a COM Express®-standard thermal interface to use with a heat sink or other cooling device.

External cooling must be provided to maintain the heatspreader plate at proper operating temperatures. Under worst-case conditions, the cooling mechanism must maintain an ambient air and heatspreader plate temperature of 60° C or less.

The aluminum slugs and thermal pads on the underside of the heatspreader assembly implement thermal interfaces between the heatspreader plate and the major heat-generating components on the COMe-bPC2. About 80 percent of the power dissipated within the module is conducted to the heatspreader plate and can be removed by the cooling solution.

You can use many thermal-management solutions with the heatspreader plates, including active and passive approaches. The optimum cooling solution varies, depending on the COM Express® application and environmental conditions. Please see the COM Express® Design Guide for further information on thermal management.

### 3.12 Heatspreader

Documentation and CAD drawings of COMe-bPC2 heatspreader and cooling solutions is provided at <http://emdcustomersection.kontron.com>.

## 3.13 Onboard Fan Connector

### Location and Pinout of Fan Connector

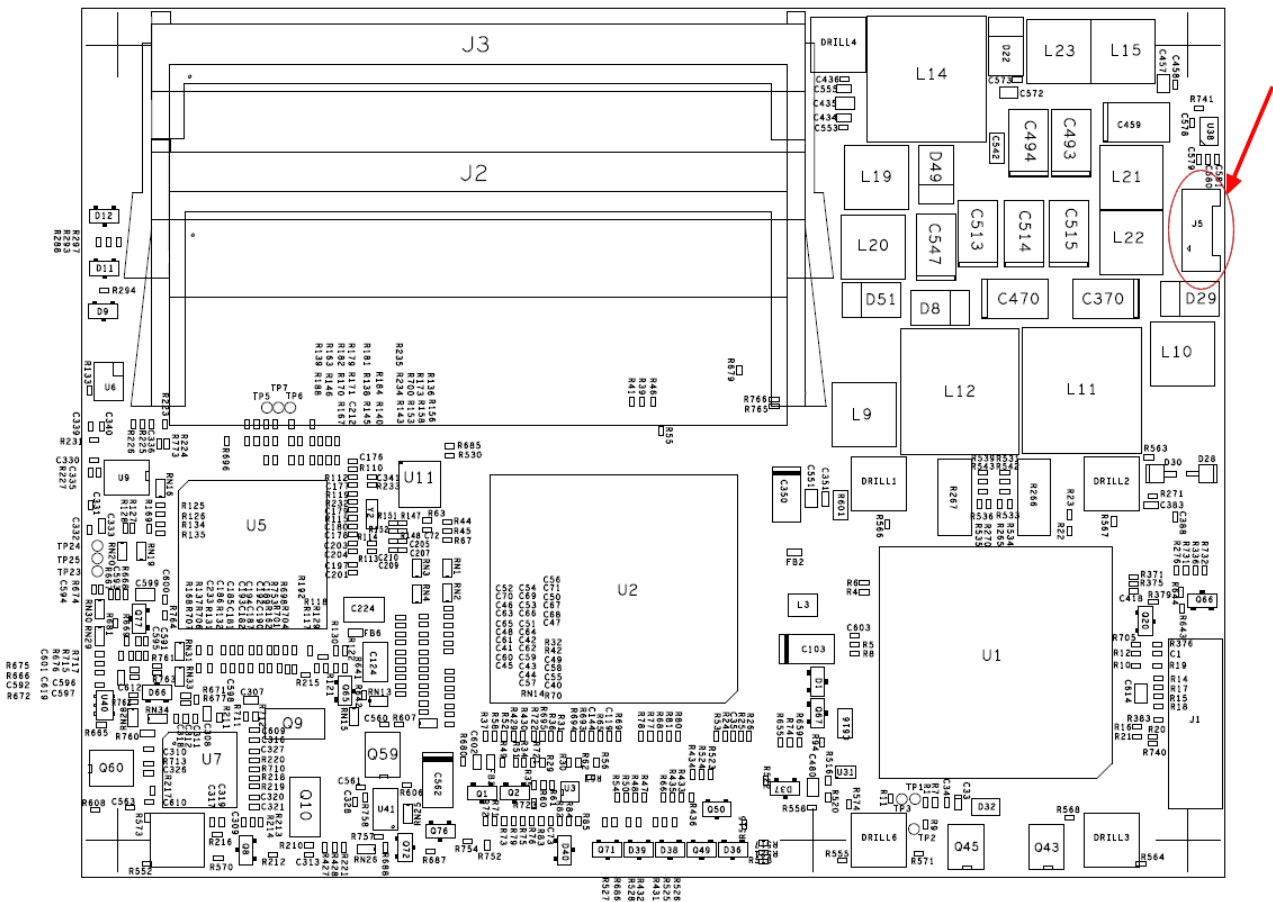

The onboard fan connector (J1) can be found near the CPU at the shorter edge of the module. Use adaptor KAB-HSP (96079-0000-00-0) to connect a standard FAN.

Connector J1 has following specification:

- » Part number (Molex) J8: 53261-0390
- » Mates with: 51021-0300
- » Crimp terminals: 50079-8100

The Pin assignment is:

- » Pin1: Tacho
- » Pin2: VCC
- » Pin3: GND

### 3.13.1 BIOS Settings for Fan Control

The fan can be controlled via the BIOS Settings “Advanced → Hardware Health → Module Hardware Health”

Advanced		BIOS SETUP UTILITY	
<b>Module Hardware Health Configuration</b>		<b>PWM Configuration Mode Setting</b>	
H/W Health Function	[Enabled]		
PWM 1 Mode Setting	[Auto Fan Mode]		
PWM 1 Ramp Rate	[Time Slot 1]		
Min PWM 1 Duty Cycle	[130]		
Absolute Temperature 1 Set	[075]		
Low Temperature 1 Limit	[065]		
Temperature 1 Range	[10 °C]		
Pulses/Rev	[2]		
Fan Voltage	[5V]		
CPU Temperature	:56 °C/132 °F	←	Select Screen
Internal Temperature	:42 °C/107 °F	↑↓	Select Item
Northbridge Temperature	:39 °C/102 °F	+−	Change Option
Fan1 Speed	: N/A	F1	General Help
3.3 V supply voltage	: 3.29 V	F10	Save and Exit
		ESC	Exit
v02.61 (C)Copyright 1985-2006, American Megatrends, Inc.			

In general 4 modes are possible

- » Auto Fan Mode: Temperature Values can be selected to control the Fan
- » Fan Always On Full: Fan is always full on
- » Fan Disable Mode: Fan is disabled
- » Fan Manually Mode: A fixed PWM value (0...255) can be entered to run the fan at a selected speed

The used hardware monitor onboard is an ADT7475. For additional information please refer to the regarding [datasheet](#).

### 3.13.2 Electrical Characteristics

Starting with revision 2.0 there are 2 version of onboard fan control possible. Our standard modules have the simple version populated. For custom projects it is possible to populate a more sophisticated one. The differences are:

Features	Premium Fan	Base Fan
Input Voltage Range	8.5V - 18V	8.5V - 18V
Output Voltage	5V / 12V	Only 12V (switch in BIOS without function)
Max. output current	1A	0.3A

The premium fan option is only available on modules with GS45 MCH.

The fan voltage is in both versions VCC of the board and limited to 12V max.



The Fan out voltage output is not short circuit proof. If necessary the user has to ensure that the circuit is protected externally, for example by a fuse on the backplane.

With premium fan solution it is recommended to select the correct fan voltage first in BIOS setup and then connect the fan.



To connect a standard FAN with 3pin connector to the module please use adaptor cable KAB-HSP 200mm (96079-0000-00-0) or KAB-HSP 40mm (96079-0000-00-2)

## 4 Features and Interfaces

### 4.1 S5 Eco Mode

Kontron's new high-efficient power-off state S5 Eco enables lowest power-consumption in soft-off state – less than 1 mA compared to the regular S5 state this means a reduction by at least factor 200!

In the "normal" S5 mode the board is supplied by 5V\_Stb and needs usually up to 300mA just to stay off. This mode allows to be switched on by power button, RTC event and WakeOnLan, even when it is not necessary. The new S5 Eco mode reduces the current tremendously.

The S5 Eco Mode can be enabled in BIOS Setup, when the BIOS supports this feature.

Following prerequisites and consequences occur when S5 Eco Mode is enabled

- » The power button must be pressed at least for 200ms to switch on.
- » Wake via Powerbutton only.
- » "Power On After Power Fail"/"State after G3": only "stay off" is possible

## 4.2 LPC

The Low Pin Count (LPC) Interface signals are connected to the LPC Bus bridge located in the CPU or chipset. The LPC low speed interface can be used for peripheral circuits such as an external Super I/O Controller, which typically combines legacy-device support into a single IC. The implementation of this subsystem complies with the COM Express® Specification. Implementation information is provided in the COM Express® Design Guide maintained by PICMG. Please refer to the official PICMG documentation for additional information.

The LPC bus does not support DMA (Direct Memory Access) and a clock buffer is required when more than one device is used on LPC. This leads to limitations for ISA bus and SIO (standard I/O 's like Floppy or LPT interfaces) implementations.

All Kontron COM Express® Computer-on-Modules imply BIOS support for following external baseboard LPC Super I/O controller features for the **Winbond/Nuvoton 5V 83627HF/G and 3.3V 83627DHG-P**:

83627HF/G	Phoenix BIOS	AMI CORE8	AMI Aptio
PS/2	YES	YES	YES
COM1/COM2	YES	YES	YES
LPT	YES	YES	YES
HWM	YES	YES	NO
Floppy	NO	NO	NO
GPIO	NO	NO	NO
83627DHG-P	Phoenix BIOS	AMI CORE8	AMI Aptio
PS/2	YES	YES	YES
COM1/COM2	YES	YES	YES
LPT	YES	YES	YES
HWM	NO	NO	NO
Floppy	NO	NO	NO
GPIO	NO	NO	NO

Features marked as not supported do not exclude OS support (e.g. HWM can be accessed via SMB). For any other LPC Super I/O additional BIOS implementations are necessary. Please contact your local sales or support for further details.



## 4.3 LPC boot

The COMe-bPC2 supports boot from an external Firmwarehub on LPC bus (LPC FWH). The external LPC FWH can be activated with signal A34 "BIOS\_DISABLE#" or according newer specifications "BIOS\_DISO#" in following configuration:

BIOS_DISO#	BIOS_DIS1#	Function
open	open	Boot on-module BIOS
GND	open	Boot baseboard LPC FWH
open	GND	Baseboard SPI = Boot Device 1, on-module SPI = Boot Device 2
GND	GND	Baseboard SPI = Boot Device 2, on-module SPI = Boot Device 1

### Using an external LPC Firmware Hub

To program an external LPC FWH follow these steps:

- » Connect a 1MB LPC FWH to the module's LPC interface
- » Open pin A34 to boot from the module BIOS
- » Boot the module to DOS with access to the BIOS image and Firmware Update Utility `afudos.exe` / batch file provided on EMD Customer Section
- » Connect pin A43 (BIOS\_DISO#) to ground to enable the external LPC FWH
- » Execute `Flash.bat` to flash the BIOS image to the external LPC FWH
- » reboot

Your module will now boot from the external LPC FWH when BIOS\_DISO# is grounded.

### To create a BIOS with custom defaults:

- » Change your BIOS settings
- » Save as custom defaults to RTC/Flash and Exit (module will now always start with these settings)
- » Extract the BIOS including custom defaults with `afudos.exe biosname.rom /O` in DOS or `kflash.exe backup biosname.rom` in Windows



Flash Backup should show "Enter new Password" first time saving custom defaults. If it is not possible to set a new password or entering a password shows an error message, please clean up CMOS data with DOS command: `jidacmos rtc /clean` (jidacmos utility is available at Kontron's Customer Section)



You can download all AMI CORE8 update utilities at AMI.com:  
<http://www.ami.com/support/downloads/amiflash.zip>

## 4.4 M.A.R.S.

The Smart Battery implementation for Kontron Computer-on-Modules called **M**obile **A**pplication for **R**echargeable **S**ystems is a BIOS extension for external Smart Battery Manager or Charger. It includes support for SMBus charger/selector (e.g. Linear Technology LTC1760 Dual Smart Battery System Manager) and provides ACPI compatibility to report battery information to the Operating System.

Reserved SM-Bus addresses for Smart Battery Solutions on the carrier:

8-bit Address	7-bit Address	Device
12h	0x09	SMART_CHARGER
14h	0x0A	SMART_SELECTOR
16h	0x0B	SMART_BATTERY

## 4.5 Fast I2C

The COMe-bPC2 supports a CPLD implemented LPC to I2C bridge using the WISHBONE I2C Master Core provided from [opencores.org](http://opencores.org). The I2C Interface supports transfer rates up to 40kB/s and can be configured in Setup

Specification for external I2C:

- » Speed up to 400kHz
- » Compatible to Philips I2C bus standard
- » Multi-Master capable
- » Clock stretching support and wait state generation
- » Interrupt or bit-polling driven byte-by-byte data-transfers
- » Arbitration lost interrupt with automatic transfer cancellation
- » Start/Stop signal generation/detection
- » Bus busy detection
- » 7bit and 10bit addressing

## 4.6 JIDA16 and JIDA32

JIDA16 (JUMPttec® Intelligent Device Architecture) is a BIOS interface which allows programs running in Real Mode operating systems (i.e. MS DOS) to call certain functions implemented in the BIOS. These functions can be used to get module information, make settings and access the I2C Bus and the Watchdog unit. JIDA16 functions are INT 15h BIOS calls which are only available in 16 Bit Real Mode operating systems.

For 32bit operating systems (i.e. WindowsXP, Windows 7, Windows CE, VxWorks, Linux) a different JIDA implementation called JIDA32 is implemented. The same common driver for all JIDA32 capable modules talks to the JIDA32 part in the BIOS, which is hardware dependent to interact with the hardware.

Please refer to [EMD Customer Section](#) for detailed documentation, JIDA utilities and Libraries for DOS, Windows, Linux, VxWorks or QNX.

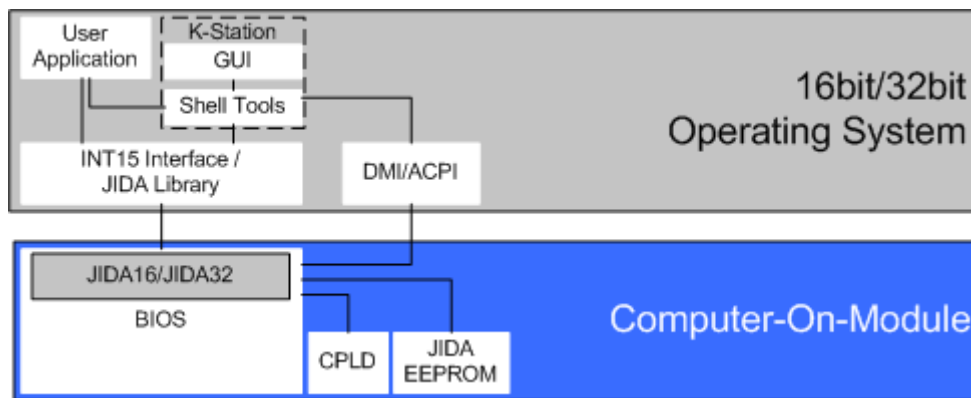

Usage of JIDA16 and JIDA32

## 4.7 K-Station 1

Based on the JIDA32 interface users can implement advanced board functionality in their application. As an example utility Kontron provides K-Station for most 32bit Windows Operating Systems. K-Station 1 is a summary of command line utilities (Shell Tools) for easy access to JIDA32 BIOS implementations. Second part of K-Station is a JAVA based example GUI which gives a view an all available features using the Shell Tools.

Following K-Station Shell Tools are available:

- » KSystemSummary.exe (System Information)
- » KGenInfo.exe (Module Information)
- » KCPUPerf.exe (CPU Throttling control)
- » KHWMon.exe (Hardware Monitoring)
- » KI2CBus.exe (I2C and SMBus access)
- » KIOPort.exe (GPIO control)
- » KStorage.exe (JIDA EEPROM access to user bytes)
- » KVGATool.exe (LVDS Backlight control)
- » KWDog.exe (Watchdog control)
- » KAMIMod.exe (AMICore8 BIOS Modification with Bootlogo or Usercode ...)
- » KFlash.exe (AMICore8 BIOS Update)

The full K-Station package, the stand-alone Shell Tools with drivers, example batch files and documentation is available on [EMD Customer Section](#) for free.

## 4.8 K-Station & API Resources

### 4.8.1 I2C

BUS	Function
I2C 0	Internal / JIDA I2C
I2C 1	SM-Bus
I2C 2	external I2C
I2C 3	internal watchdog
I2C 4	SDVO DDC
I2C 5	CRT DDC
I2C 6	JILI DDC

### 4.8.2 Storage

Device	Function
EEPROM 0	JIDA EEPROM Area1 with 32 Bytes (free to use)

### 4.8.3 GPIO

Port	Function
IO-Port 0	GPI 0
IO-Port 1	GPI 1
IO-Port 2	GPI 2
IO-Port 3	GPI 3
IO-Port 4	GPO 0
IO-Port 5	GPO 1
IO-Port 6	GPO 2
IO-Port 7	GPO 3

### 4.8.4 Hardware Monitor

Sensor	Function
Temp 0	CPU ACPI Temperature
Temp 1	Internal HWM Temperature (inside ADT7476)
Temp 2	Chipset Temperature (Intel®; 4 series chipset)
Temp 3	External SIO Winbond 83627 Temp Sensor 0
Temp 3	External SIO Winbond 83627 Temp Sensor 1
Temp 5	External SIO Winbond 83627 Temp Sensor 2
FAN 0	CPU fan controlled by ADT7476
FAN 1	External SIO Winbond 83627 FAN Sensor 0
FAN 2	External SIO Winbond 83627 FAN Sensor 1
FAN 3	External SIO Winbond 83627 FAN Sensor 2
Voltage 0	Internal ADT7476 Battery Voltage: VBAT
Voltage 1	Internal ADT7476 Supply Voltage: VCC
Voltage 2	External SIO Winbond 83627 CPU Core Voltage Sensor: VCoreA
Voltage 3	External SIO Winbond 83627 CPU Core Voltage Sensor: VCoreB
Voltage 4	External SIO Winbond 83627 Battery Voltage Sensor: VBAT
Voltage 5	External SIO Winbond 83627 Voltage Sensor 3: +3.3V
Voltage 6	External SIO Winbond 83627 Voltage Sensor 4: +5V
Voltage 7	External SIO Winbond 83627 Voltage Sensor 5: +5VSB
Voltage 8	External SIO Winbond 83627 Voltage Sensor 6: +12V
Voltage 9	External SIO Winbond 83627 Voltage Sensor 7: -5V
Voltage 10	External SIO Winbond 83627 Voltage Sensor 8: -12V



Resources based on BIOS revision CNTGR415

## 4.9 GPIO - General Purpose Input and Output

The COMe-bPC2 offers 4 General Purpose Input (GPI) pins and 4 General Purpose Output (GPO) pins. On a 3.3V level digital in- and outputs are available.

Signal	Pin	Description
GPI0	A54	General Purpose Input 0
GPI1	A63	General Purpose Input 1
GPI2	A67	General Purpose Input 2
GPI3	A85	General Purpose Input 3
GPO0	A93	General Purpose Output 0
GPO1	B54	General Purpose Output 1
GPO2	B57	General Purpose Output 2
GPO3	B63	General Purpose Output 3

### Configuration



The GPI and GPO pins can be configured via JIDA32/K-Station. Please refer to the JIDA32/K-Station manual in the driver download packet on our [customer section](#).

## 4.10 Watchdog Timer

You can configure the Watchdog Timer (WDT) in BIOS setup to start after a set amount of time after power-on boot. The WDT can also be controlled by the JIDA32 Library API. The application software should strobe the WDT to prevent its timeout. Upon timeout, the WDT resets and restarts the system. This provides a way to recover from program crashes or lockups.

### Configuration

You can program the timeout period for the watchdog timer in two ranges:

- » 1-second increments from 1 to 255 seconds
- » 1-minute increments from 1 to 255 minutes

Contact Kontron Embedded Modules technical support for information on programming and operating the WDT.



## 4.11 Flash Backup Feature

The COMe-bPC2 supports a new functionality called “Flash Backup”. This new feature allows saving custom defaults directly into the Flash. With invalid EEPROM data or without a CMOS EEPROM, the module will start up with these custom defaults. It’s possible to save this BIOS with changed defaults to an image and flash it on other modules.

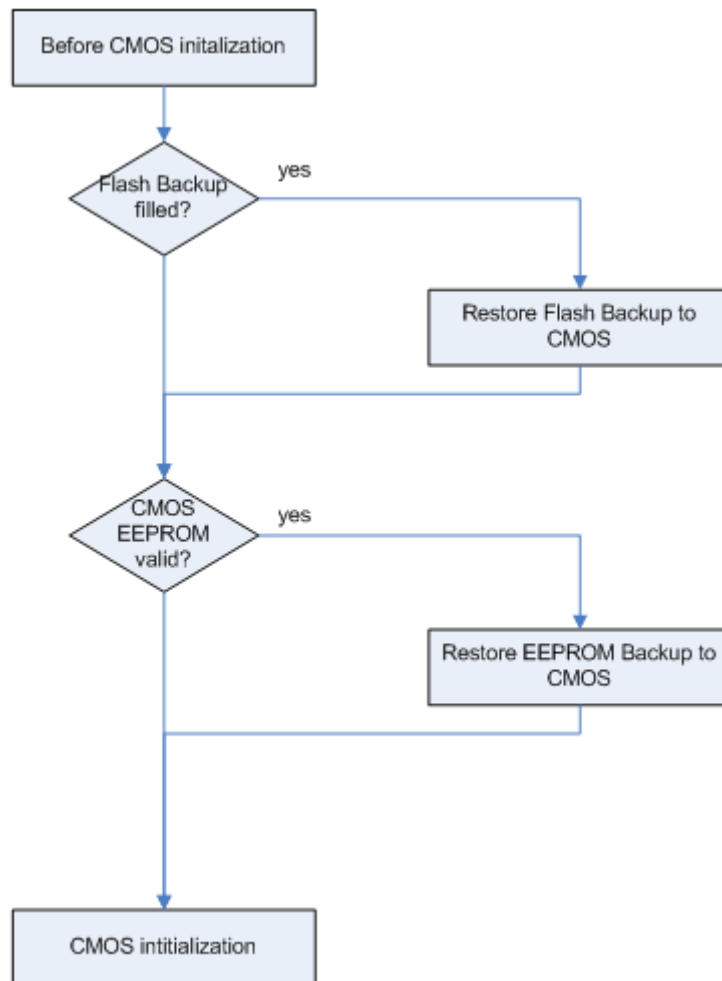

### To create a BIOS with custom defaults:

- » Change your BIOS settings
- » Save as custom defaults to RTC/Flash and Exit (module will now always start with these settings)



Flash Backup should show “Enter new Password” first time saving custom defaults. If it is not possible to set a new password or entering a password shows an error message, please clean up CMOS data with DOS command: **jidacmos rtc /clean** (jidacmos utility is available at Kontron’s Customer Section)

- » Extract the BIOS including custom defaults with afudos or kflash utility for windows

Tool	Command
AFUDOS	c:\>afudos.exe biosname.rom /0
KFLASH	c:\>kflash.exe backup biosname.rom

## Flash your BIOS with custom defaults:

To flash a BIOS with customized defaults extracted like described above, use following options

Operating System	Command
Windows OS	<code>c:\&gt;kflash.exe flash biosname.rom /bncr</code>
DOS	<code>c:\&gt;afudos.exe biosname.rom /p /b /n /c</code> <code>c:\&gt;jidacmos.exe eep /clean</code>



kflash.exe is a shell tool included in Kontron K-Station System Utility Package.  
jidacmos utility is included in the BIOS download packages at Kontron's customer section.

## 4.12 Speedstep Technology

The Intel® processors offers the Intel® Enhanced SpeedStep™ technology that automatically switches between maximum performance mode and battery-optimized mode, depending on the needs of the application being run. It let you customize high performance computing on your applications. When powered by a battery or running in idle mode, the processor drops to lower frequencies (by changing the CPU ratios) and voltage, conserving battery life while maintaining a high level of performance. The frequency is set back automatically to the high frequency, allowing you to customize performance.

In order to use the Intel® Enhanced SpeedStep™ technology the operating system must support SpeedStep™ technology.

By disabling the SpeedStep feature in the BIOS, manual control/modification of CPU performance is possible. Setup the CPU Performance State in the BIOS Setup or use 3rd party software to control CPU Performance States.

## 4.13 C-States

New generation platforms include power saving features like SuperLFM, EIST (P-States) or C-States in O/S idle mode.

Activated C-States are able to dramatically decrease power consumption in idle mode by reducing the Core Voltage or switching of parts of the CPU Core, the Core Clocks or the CPU Cache.

Following C-States are defined:

C-State	Description	Function
C0	Operating	CPU fully turned on
C1	Halt State	Stops CPU main internal clocks via software
C1E	Enhanced Halt	Similar to C1, additionally reduces CPU voltage
C2	Stop Grant	Stops CPU internal and external clocks via hardware
C2E	Extended Stop Grant	Similar to C2, additionally reduces CPU voltage
C3	Deep Sleep	Stops all CPU internal and external clocks
C3E	Extended Stop Grant	Similar to C3, additionally reduces CPU voltage
C4	Deeper Sleep	Reduces CPU voltage
C4E	Enhanced Deeper Sleep	Reduces CPU voltage even more and turns off the memory cache
C6	Deep Power Down	Reduces the CPU internal voltage to any value, including 0V
C7	Deep Power Down	Similar to C6, additionally LLC (LastLevelCache) is switched off

C-States are usually enabled by default for low power consumption, but active C-States may influence performance sensitive applications or real-time systems.

» Active C6-State may influence data transfer on external Serial Ports

» Active C7-State may cause lower CPU and Graphics performance

It's recommended to disable C-States / Enhanced C-States in BIOS Setup if any problems occur.

## 4.14 Dynamic FSB Frequency Switching

Dynamic FSB frequency switching effectively reduces the internal bus clock frequency in half to further decrease the minimum processor operating frequency from the Enhanced Intel SpeedStep Technology performance states and achieve the Super Low Frequency Mode (Super LFM). This feature is supported at FSB frequencies of 1066 MHz, 800 MHz and 667 MHz and does not entail a change in the external bus signal (BCLK) frequency. Instead, both the processor and GMCH internally lower their BCLK reference frequency to 50% of the externally visible frequency. Both the processor and GMCH maintain a virtual BCLK signal (VBCLK) that is aligned to the external BCLK but at half the frequency.

After a downward shift, it would appear externally as if the bus is running with a 133-MHz base clock in all aspects, except that the actual external BCLK remains at 266 MHz. See Figure 3 for details. The transition into Super LFM, a “down-shift,” is done following a handshake between the processor and GMCH. A similar handshake is used to indicate an “up-shift,” a change back to normal operating mode. Please ensure this feature is enabled and supported in the BIOS.

## 4.15 VID-x

The processor implements the VID-x feature for improved control of core voltage levels when the processor enters a reduced power consumption state. VID-x applies only when the processor is in the Intel Dynamic Acceleration Technology performance state and one or more cores are in low-power state (i.e., CC3/CC4/CC6). VID-x provides the ability for the processor to request core voltage level reductions greater than one VID tick. The amount of VID tick reduction is fixed and only occurs while the processor is in Intel Dynamic Acceleration Technology mode. This improved voltage regulator efficiency during periods of reduced power consumption allows for leakage current reduction which results in platform power savings and extended battery life.

When in Intel Dynamic Acceleration Technology mode, it is possible for both cores to be active under certain internal conditions. In such a scenario the processor may draw a Instantaneous current (ICC\_CORE\_INST) for a short duration of tINST; however, the average ICC current will be lesser than or equal to ICCDES current specification.

## 4.16 Enhanced Intel Dynamic Acceleration Technology

The processor supports Intel Dynamic Acceleration Technology mode. The Intel Dynamic Acceleration Technology feature allows one core of the processor to operate at a higher frequency point when the other core is inactive and the operating system requests increased performance. This higher frequency is called the opportunistic frequency and the maximum rated operating frequency is the ensured frequency. The processor includes a hysteresis mechanism that improves overall Intel Dynamic Acceleration Technology performance by decreasing unnecessary transitions of the cores in and out of Intel Dynamic Acceleration Technology mode. Normally, the processor would exit Intel Dynamic Acceleration Technology as soon as two cores are active. This can become an issue if the idle core is frequently awakened for a short periods (i.e., high timer tick rates). The hysteresis mechanism allows two cores to be active for a limited time before it transitions out of Intel Dynamic Acceleration Technology mode.

Intel Dynamic Acceleration Technology mode enabling requires:

- » Exposure, via BIOS, of the opportunistic frequency as the highest ACPI P state
- » Enhanced Multi-Threaded Thermal Management (EMTTM)
- » Intel Dynamic Acceleration Technology mode and EMTTM MSR configuration via BIOS

## 4.17 Usage of Different Graphic Interfaces

The COMe-bPC2 offers VGA, PCIexpress Graphics, LVDS, HDMI, SDVO and Displayport interfaces to connect graphical user interfaces. The usage of VGA, PCIexpress and SDVO complies with the current COM Express® Specification.

The principle of using them is shown in the next drawing.

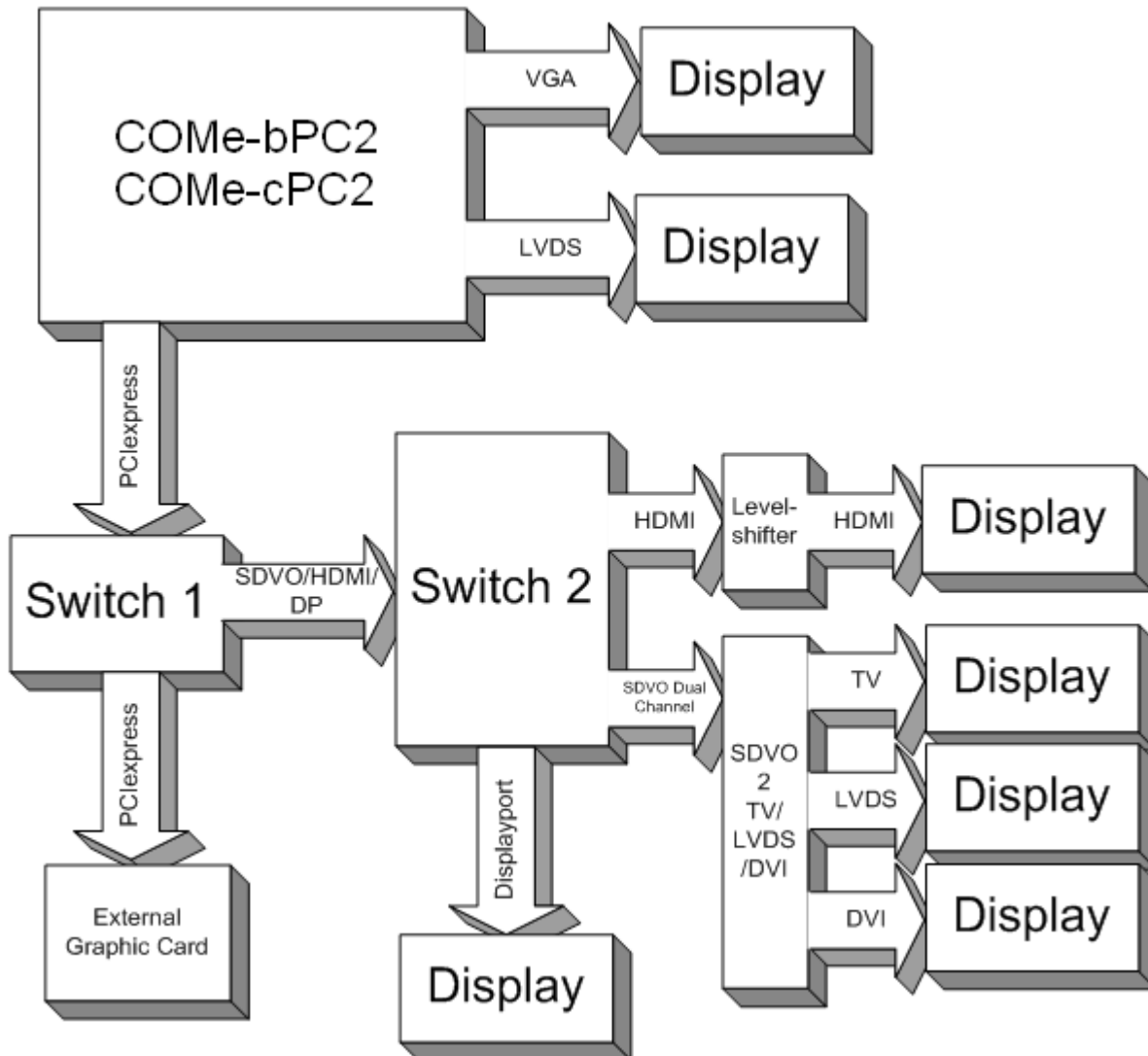

VGA and LVDS interface is always available and can be used. The pins of PCIexpress Graphics either are used as PCIexpress Graphics or as HDMI/SDVO/DP, which is controlled by switch1.

Switch1 is the SDVO\_SDA# line (C73). When this signal is high (2.5V) the SDVO/HDMI/DP output is enabled. Otherwise the lines can be used as PCIexpressGraphic.

The switch 2 to select HDMI, SDVO or Displayport consists of the devices detected on the regarding sense circuits. When there is an SDVO 2 TV/LVDS/DVI converter found on the SDVO\_DATA and \_CLK lines (C73; D73) then the output is switched to SDVO. When there is Displayport device found on the Displayport AUX lines (C71; C72) then it is Display port and in any other case the output is switched to HDMI.



## 4.18 Alternative Pin-out of HDMI

Pin Nr.	Pin Name PCIeexpress	Pin Name HDMI	HDMI Pin Description
D61	PCIexpress Graphics Transmit + 3	TMDS_B_CLK	HDMI Port B Clock
D62	PCIexpress Graphics Transmit - 3	TMDS_B_CLK#	HDMI port B Clock complement
D58	PCIexpress Graphics Transmit + 2	TMDS_B_DATA0	HDMI port B Data0
D59	PCIexpress Graphics Transmit - 2	TMDS_B_DATA0#	HDMI port B Data0 complement
D55	PCIexpress Graphics Transmit + 1	TMDS_B_DATA1	HDMI port B Data1
D56	PCIexpress Graphics Transmit - 1	TMDS_B_DATA1#	HDMI port B Data1 complement
D52	PCIexpress Graphics Transmit + 0	TMDS_B_DATA2	HDMI port B Data2
D53	PCIexpress Graphics Transmit - 0	TMDS_B_DATA2#	HDMI port B Data2 complement
C61	PCIexpress Graphics Receive + 3	TMDS_B_HPD#	HDMI port B Hot-plug detect
D74	PCIexpress Graphics Transmit + 7	TMDS_C_CLK	HDMI port C Clock
D75	PCIexpress Graphics Transmit - 7	TMDS_C_CLK#	HDMI port C Clock complement
D71	PCIexpress Graphics Transmit + 6	TMDS_C_DATA0	HDMI port C Data0
D72	PCIexpress Graphics Transmit - 6	TMDS_C_DATA0#	HDMI port C Data0 complement
D68	PCIexpress Graphics Transmit + 5	TMDS_C_DATA1	HDMI port C Data1
D69	PCIexpress Graphics Transmit - 5	TMDS_C_DATA1#	HDMI port C Data1 complement
D65	PCIexpress Graphics Transmit + 4	TMDS_C_DATA2	HDMI port C Data2
D66	PCIexpress Graphics Transmit - 4	TMDS_C_DATA2#	HDMI port C Data2 complement
C74	PCIexpress Graphics Receive + 7	TMDS_C_HDP#	HDMI port C Hot-plug detect

## 4.19 Alternative Pin-out of Display Port

Pin Nr.	Pin Name PCIeexpress	Pin Name HDMI	HDMI Pin Description
D61	PCIexpress Graphics Transmit + 3	DPB_LANE3	Displayport B Lane3
D62	PCIexpress Graphics Transmit - 3	DPB_LANE3#	Displayport B Lane3 complement
D58	PCIexpress Graphics Transmit + 2	DPB_LANE2	Displayport B Lane2
D59	PCIexpress Graphics Transmit - 2	DPB_LANE2#	Displayport B Lane2 complement
D55	PCIexpress Graphics Transmit + 1	DPB_LANE1	Displayport B Lane1
D56	PCIexpress Graphics Transmit - 1	DPB_LANE1#	Displayport B Lane1 complement
D52	PCIexpress Graphics Transmit + 0	DPB_LANE0	Displayport B Lane0
D53	PCIexpress Graphics Transmit - 0	DPB_LANE0#	Displayport B Lane0 complement
C61	PCIexpress Graphics Receive + 3	DPB_HPD#	Displayport B Hot-plug detect
C58	PCIexpress Graphics Receive + 2	DPB_AUX	Displayport B Aux
C59	PCIexpress Graphics Receive - 2	DPB_AUX#	Displayport B Aux complement
D74	PCIexpress Graphics Transmit + 7	DPC_LANE3	Displayport C Lane3
D75	PCIexpress Graphics Transmit - 7	DPC_LANE3#	Displayport C Lane3 complement
D71	PCIexpress Graphics Transmit + 6	DPC_LANE2	Displayport C Lane2
D72	PCIexpress Graphics Transmit - 6	DPC_LANE2#	Displayport C Lane2 complement
D68	PCIexpress Graphics Transmit + 5	DPC_LANE1	Displayport C Lane1
D69	PCIexpress Graphics Transmit - 5	DPC_LANE1#	Displayport C Lane1 complement
D65	PCIexpress Graphics Transmit + 4	DPC_LANE0	Displayport C Lane0
D66	PCIexpress Graphics Transmit - 4	DPC_LANE0#	Displayport C Lane0 complement
C74	PCIexpress Graphics Receive + 7	DPC_HPD#	Displayport C Hot-plug detect
C71	PCIexpress Graphics Receive + 6	DPC_AUX	Displayport C Aux
C72	PCIexpress Graphics Receive - 6	DPC_AUX#	Displayport C Aus complement
D88	PCIexpress Graphics Transmit + 11	DPD_LANE3	Displayport D Lane3
D89	PCIexpress Graphics Transmit - 11	DPD_LANE3#	Displayport D Lane3 complement
D85	PCIexpress Graphics Transmit + 10	DPD_LANE2	Displayport D Lane2
D86	PCIexpress Graphics Transmit - 10	DPD_LANE2#	Displayport D Lane2 complement
D81	PCIexpress Graphics Transmit + 9	DPD_LANE1	Displayport D Lane1
D82	PCIexpress Graphics Transmit - 9	DPD_LANE1#	Displayport D Lane1 complement
D78	PCIexpress Graphics Transmit + 8	DPD_LANE0	Displayport D Lane0
D77	PCIexpress Graphics Transmit - 8	DPD_LANE0#	Displayport D Lane0 complement
C88	PCIexpress Graphics Receive + 11	DPD_HPD#	Displayport D Hot-plug detect
C85	PCIexpress Graphics Receive + 10	DPD_AUX	Displayport D Aux
C86	PCIexpress Graphics Receive - 10	DPD_AUX#	Displayport D Aus complement

## 4.20 Display Configurations

The chapter describes possible display configurations and supported features for the integrated Intel® GMA X4500MHD (Gen5.5) graphics.

Display	N/A	CRT	LVDS fixed	LVDS DID	LVDS2DVI	DP	DP2DVI	DP2HDMI	DP2CRT
N/A	-	S	S	S	S	S	S	S	S
CRT	S	-	A	A	A	A	A	A	A
LVDS fixed	S	A	-	-	-	A	A	A	A
LVDS DID	S	A	-	-	-	A	A	A	A
LVDS2DVI	S	A	-	-	-	A	A	A	A
DP	S	A	A	A	A	A	A	A	A
DP2DVI	S	A	A	A	A	A	A	A	A
DP2HDMI	S	A	A	A	A	A	A	A	A
DP2CRT	S	A	A	A	A	A	A	A	tbd

» S = Single Display

» A = All Modes (Single Display, Clone Mode, Extended Desktop)

» - = Not supported

» N/A = Display not attached



Tested in Windows 7 with Intel GMA HD 15.15.6.1892, BIOS CNTGR414

## Digital Display Interface Features

The integrated Intel® GMA X4500MHD (Gen5.5) graphics supports:

- » One stream high-bandwidth Digital Content Protection (HDCP) on HDMI or DisplayPort (requires optional available HDCP Key)
- » One active Protected Audio and Video Path (PAVP) session on HDMI or DisplayPort
- » HDMI Audio if activated in BIOS and O/S
- » DP/HDMI/DVI Hot-plug (low-active)

## DDI Design Consideration

- » For sufficient signal quality baseboard designs with long signal lanes or impedance leaps may require an Equalizer or Redriver for the digital display interfaces
- » Monitor Hot-plug detection is usually high-active. On COMe-bPC2 the hot-plug is low active and requires conversion on the baseboard

## Supported Audio Formats on HDMI

- » AC-3 Dolby Digital
- » Dolby Digital Plus
- » DTS-HD
- » LPCM, 192kHz/24bit, 8 channel
- » Dolby True HD, DTS HD Master Audio

## 4.21 Hybrid Graphics / Multi-monitor

The COMe-bPC2 supports Hybrid Multi-monitor function which is one form of Intel's Hybrid Graphics where integrated graphics (in Chipset or CPU) is available to operate simultaneously with external PEG; PCIe or PCI graphics. This feature enables concurrent function of Intel's integrated Graphics Processing Unit (GPU/iGFX) along with a discrete GPU solution, allowing for operability of greater than two independently-driven displays. The O/S will handle control of the multiple GPU display adapters appropriately. For example, WindowsXP supports The Microsoft Windows XP Display Driver Model (XPDM) which allows loading and support of multiple graphics drivers. Windows 7 continues that legacy XPDM support but also adds WDDM v1.1 which, like XPDM, allows for simultaneous multiple graphics drivers (Windows Vista WDDM v1.0 did not allow this capability). Operating system applications will be adapter-unaware through use of the O/S GUI APIs and will utilize the adapter associated with the primary display, regardless of which display the image is located on.



Some applications may be adapter-aware, e.g., full-screen applications and system applications like the compositor. A number of software tools designed to assist multi-monitor use are available from third parties. One example is the UltraMon\* utility for multi-monitor systems, which helps with the position of applications, assists desktop wallpapers and screen savers in multi-monitor configurations.

Hybrid Multi-monitor mode is recommended to be accomplished using a discrete third-party PCI Express graphics card either into the PEG slot of the platform or into an available PCI Express slot routed off of the I/O subsection of the chipset.

### Requirements

- » Baseboard supporting PEG (alternatively PCIe or PCI)
- » Module BIOS which allows switching between iGFX and discrete GPU (iGFX must be set to primary boot display)
- » O/S supporting heterogeneous display adapters (Linux / WindowsXP / Windows 7)

### Setup a Multi-monitor system

- » Start without the discrete GPU seated in the system
- » Select IGD as Primary Boot Display in BIOS Setup
- » Boot into O/S and install drivers requested for the integrated GPU
- » Shut down the system and insert the discrete GPU
- » Boot into O/S and install drivers requested for the discrete GPU (if necessary in Safe mode)
- » Set the Windows Display properties as referenced below (example: WindowsXP)



In most cases the graphical user interfaces (e.g. ATI Catalyst Control Center) for both GPUs may not run properly. It's recommended to use O/S implemented Display Properties like in screenshot above



Detailed documentation is available in Intel Paper [323214](#)

## 4.22 Intel® vPro™ technology

Kontron and Intel® are addressing the security and manageability challenges facing embedded systems today with the implementation of Intel® vPro™ technology to enable: » System integrity » Secure isolation » Remote systems management

First, system integrity is the ability to identify whether the system hardware or system software has been modified without authorization. When a system's integrity is known, the system can be thought of as a trusted system. Second, secure isolation is the ability to use platform hardware to separate processes, resources, and data on the system such that they cannot interact with each other in unintended ways. By providing hardware-assisted isolation, there are limitless security, privacy, and cost savings that can be realized through consolidation and workload isolation. Finally, remote systems management is the ability to troubleshoot, perform power management or system verification through secure channels. Significant cost savings and efficiencies can be realized through remote management allowing for increased system up time and the ability to manage or diagnose a system, even when powered down.

Intel® vPro™ technology itself is special functionality designed into the both the processor and the chipset. The three technologies that comprise Intel® vPro™ technology are: Intel Virtualization Technology (Intel® VT), Intel Trusted Execution Technology (Intel® TXT) and Intel Active Management Technology (Intel® AMT).

Intel® VT provides hardware-based assists making secure isolation more efficient and decreases the virtualization footprint, lowering the effective attack surface of a solution. This hardware-based technology can help to protect applications and information by running multiple operating systems (OSs) in isolation on the same physical system. A virtual guest OS can be created in an entirely separate space on the physical system to run specialized or critical applications. Virtual environments leverage Intel® VT for memory, CPU, and Directed I/O virtualization. Intel® TXT provides the ability to use hardware-based mechanisms to verify system integrity during the boot process. It also provides system memory scrubbing that protects against soft reset attacks. Virtualized environments take advantage of Intel® TXT launch environment verification to establish a dynamic root of trust providing added security to hypervisor or virtual machine monitor (VMM).

Mechanisms employed by Intel® AMT include domain authentication, session keys, persistent data storage in the Intel® AMT hardware, and access control lists. Only firmware images that are digitally signed by Intel are permitted to load and execute. This set of hardware-based features is targeted for businesses and allows remote access to the system, whether wired or wireless, for management and security tasks. Because of the special hardware capabilities provided by Intel® AMT, out of band access is available even when the OS is not functional or system power is off.



Intel® TXT and Intel® AMT are disabled by default. Please contact your local sales or support for BIOS versions with full vPro™ support

## 4.23 ACPI Suspend Modes and Resume Events

The COMe-bPC2 supports the S3 state (=Save to Ram). S4 (=Save to Disk) is not supported by the BIOS (S4\_BIOS) but S4\_OS is supported by the following operating systems:

- » Windows XP
- » Windows Vista
- » Windows 7

**The following events resume the system from S3:**

- » USB Keyboard (1)
- » USB Mouse (1)
- » Power Button
- » WakeOnLan (2)

**The following events resume the system from S4:**

- » Power Button
- » WakeOnLan (2)

**The following events resume the system from S5:**

- » Power Button
- » WakeOnLan (2)



(1) OS must support wake up via USB devices and baseboard must power the USB Port with StBy-Voltage

(2) WakeOnLan must be enabled in BIOS setup and driver options

## 5 System Resources

### 5.1 Interrupt Request (IRQ) Lines

Please be aware that an ACPI OS decides itself on resource usage. The tables below show only an example distribution.

#### 5.1.1 In 8259 PIC Mode

IRQ#	Used For	Available	Comment
0	Timer 0	No	-
1	Keyboard	No	Note (4)
2	Slave 8259	No	-
3	-	Yes	-
4	-	Yes	-
5	-	Yes	-
6	-	Yes	-
7	-	Yes	-
8	RTC	No	-
9	SCI	No	Note (3)
10	-	Yes	-
11	-	Yes	-
12	PS/2 Mouse	No	Note (5)
13	FPU	No	-
14	IDE0	No	Note (1)(2)
15	IDE1	No	Note (1)(2)

1 If the "Used For" device is disabled in setup, the corresponding interrupt is available for other devices.

2 if sata controller is operating in legacy mode



3 Unavailable in Advanced Configuration and Power Interface (ACPI) mode. Used as System Control Interrupt (SCI) in ACPI mode. Currently not free in Non-ACPI mode.

4 used by legacy keyboard controller when available on carrier board.

5 used by legacy ps/2 mouse controller when available on carrier board.



## 5.1.2 In APIC mode

IRQ#	Used For	Available	Comment
0	Timer 0	No	-
1	Keyboard	No	-
2	Slave 8259	No	-
3	-	Yes	Note (4)
4	-	Yes	Note (4)
5	-	Yes	Note (4)
6	-	Yes	Note (4)
7	-	Yes	Note (4)
8	RTC	No	-
9	SCI	No	Note (2)
10	-	Yes	Note (4)
11	-	Yes	Note (4)
12	-	Yes	Note (4)
13	FPU	No	-
14	IDE0	No	Note (1)(3)
15	IDE1	No	Note (1)(3)
16	PIRQ[A]	For PCI	PCI IRQ line 1 + Graphics controller + HD Audio Controller + secondary IDE Note (4)
17	PIRQ[B]	For PCI	PCI IRQ line 2 + HD Audio controller Note (4)
18	PIRQ[C]	For PCI	PCI IRQ line 3 + USB UCHI controller #3 + SATA (native mode) Note (4)
19	PIRQ[D]	For PCI	PCI IRQ line 4 + USB UCHI controller #2 + IDE (native mode) Note (4)
20	PIRQ[E]	No	Lan Controller Note (4)
21	PIRQ[F]	No	Note (4)
22	PIRQ[G]	No	Note (4)
23	PIRQ[H]	No	USB EHCI controller, USB UCHI controller #1 Note (4)

1 If the "Used For" device is disabled in setup, the corresponding interrupt is available for other devices.



2 Unavailable in Advanced Configuration and Power Interface (ACPI) mode. Used as System Control Interrupt (SCI) in ACPI mode. Currently not free in Non-ACPI mode.

3 IRQs are available if IDE controller is either disabled in setup or if in Native IDE mode.

4 ACPI Operating System decides on particular IRQ usage.

## 5.2 Direct Memory Access (DMA) Channels

DMA#	Used For	Available	Comment
0	-	No	-
1	-	No	-
2	-	No	-
3	-	No	-
4	Cascade	No	-
5	-	No	-
6	-	No	-
7	-	No	-

## 5.3 Memory Area

Upper Memory	Used For	Available	Comment
C0000h-CFFFFh	VGA BIOS	No	-
D0000h-DFFFFh	-	Yes	LPC Bus or Shadow RAM
E0000h-EFFFFh	System BIOS	No	-

## 5.4 I/O Address Map

Upper Memory	Used For	Available	Comment
400h-41Fh	Chipset	No	Always used by chipset
4D0h-4D1h	Interrupt Controller	No	-
500h-53Fh	Chipset	No	Always used by chipset
800h-87Fh	Chipset	No	Always used by chipset
1000h>	PCI	No	-

## 5.5 External Inter-IC (I2C) Bus

I2C Address	Used For	Available	Comment	JIDA Bus Nr.
-	-	-	-	2

## 5.6 System Management (SM) Bus

SMB Address	Used For	Available	Comment	JIDA Bus Nr.
10h	SMB Host	No	EEPROM for CMOS Data	1
12h	SMART_Charger	No	Only be used by a SMB Charger	1
14h	SMART_Selector	No	Only be used by a SMB Selector or Manager	1
16h	SMART_Battery	No	Only be used by a SMB Battery	1
A0h	SPD	No	DDR3 channel A	1
A4h	SPD	No	DDR3 channel B	1
5Ch	HW-Monitor	No	-	1
D2h	Clockgenerator	No	-	1

## 5.7 JILI I2C Bus

I2C Address	Used For	Available	Comment	JIDA Bus Nr.
A0h	DDC	No	Display Data	6
62h	MAX6253	No	DAC for Backlight brightness	6

## 5.8 SDVO I2C Bus

I2C Address	Used For	Available	Comment	JIDA Bus Nr.
A0h	DDC	No	Display Data	4

## 5.9 CRT I2C Bus

I2C Address	Used For	Available	Comment	JIDA Bus Nr.
A0h	DDC	No	Display Data	5



JIDA Bus Nr. 0 and Bus Nr. 3 are for internal use only.

## 6 Connectors

The pinouts for Interface Connectors X1A and X1B are documented for convenient reference. Please see the COM Express® Specification and COM Express® Design Guide for detailed, design-level information.

### 6.1 Connector Location

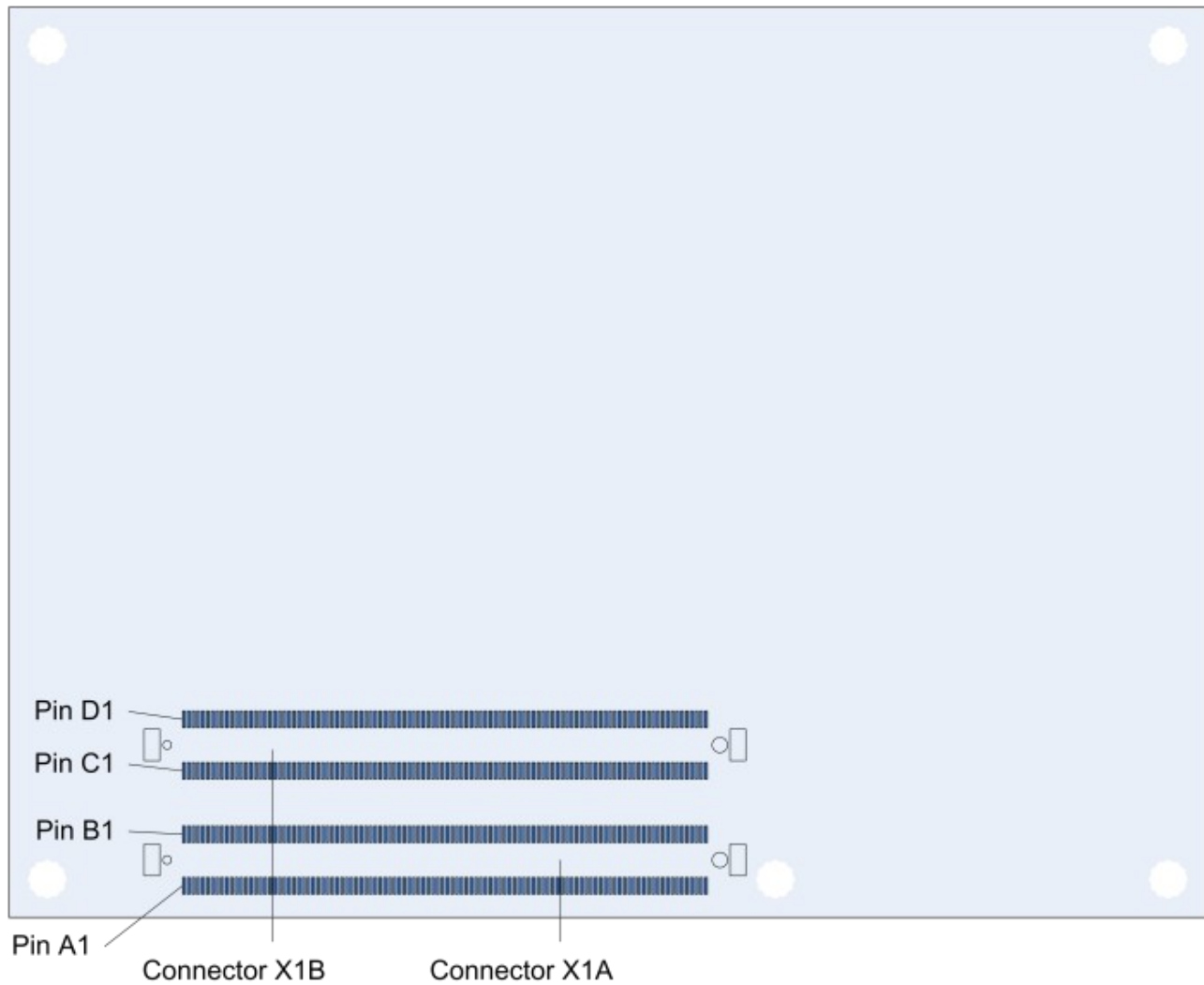

## 7 Pinout List

### 7.1 General Signal Description

Type	Description
I/O-3,3	Bi-directional 3,3 V I/O-Signal
I/O-5T	Bi-dir. 3,3V I/O (5V Tolerance)
I/O-5	Bi-directional 5V I/O-Signal
I-3,3	3,3V Input
I/OD	Bi-directional Input/Output Open Drain
I-5T	3,3V Input (5V Tolerance)
OA	Output Analog
OD	Output Open Drain
O-1,8	1,8V Output
O-3,3	3,3V Output
O-5	5V Output
DP-I/O	Differential Pair Input/Output
DP-I	Differential Pair Input
DP-O	Differential Pair Output
PU	Pull-Up Resistor
PD	Pull-Down Resistor
PWR	Power Connection



To protect external power lines of peripheral devices, make sure that: the wires have the right diameter to withstand the maximum available current the enclosure of the peripheral device fulfills the fire-protection requirements of IEC/EN60950

## 7.2 Connector X1A Row A

Pin	Signal	Description	Type	Termination	Comment
A1	GND	Power Ground	PWR	-	-
A2	GBE0_MDI3-	GBE0_MDI3_N ; Ethernet Receive Data -	DP-I	-	-
A3	GBE0_MDI3+	GBE0_MDI3_P ; Ethernet Receive Data -	DP-I	-	-
A4	GBE0_LINK100#	GBE0_LINK100# ; Ethernet Speed LED	0-3,3	-	-
A5	GBE0_LINK1000#	GBE0_LINK1000# ; Ethernet Speed LED	0-3,3	-	-
A6	GBE0_MDI2-	GBE0_MDI2_N ; Ethernet Receive Data -	DP-I	-	-
A7	GBE0_MDI2+	GBE0_MDI2_P ; Ethernet Receive Data -	DP-I	-	-
A8	GBE0_LINK#	GBE0_LINK# ; LAN Link LED	OD	-	-
A9	GBE0_MDI1-	GBE0_MDI1_N ; Ethernet Receive Data -	DP-I	-	-
A10	GBE0_MDI1+	GBE0_MDI1_P ; Ethernet Receive Data +	DP-I	-	-
A11	GND	Power Ground	PWR	-	-
A12	GBE0_MDIO-	GBE0_MDIO_N ; Ethernet Transmit Data -	DP-0	-	-
A13	GBE0_MDIO+	GBE0_MDIO_P ; Ethernet Transmit Data +	DP-0	-	-
A14	GBE0_CTREF	GBE0_CTREF	0-1,8	-	is on a power rail controlled by Intels ME
A15	SUS_S3#	PM_SLP_S3_EXT#	0-3,3	PU 10k 3,3V (S5)	-
A16	SATA0_TX+	SATA_TX0_P ; SATA 0 Transmit Data +	DP-0	-	-
A17	SATA0_TX-	SATA_TX0_N ; SATA 0 Transmit Data -	DP-0	-	-
A18	SUS_S4#	PM_SLP_S4_EXT#	0-3,3	-	-
A19	SATA0_RX+	SATA_RX0_P ; SATA 0 Receive Data +	DP-I	-	-
A20	SATA0_RX-	SATA_RX0_N ; SATA 0 Receive Data -	DP-I	-	-
A21	GND	Power Ground	PWR	-	-
A22	SATA2_TX+	SATA_TX2_P ; SATA 2 Transmit Data +	DP-0	-	-
A23	SATA2_TX-	SATA_TX2_N ; SATA 2 Transmit Data -	DP-0	-	-
A24	SUS_S5#	PM_SLP_S#5	0-3,3	-	-
A25	SATA2_RX+	SATA_RX2_P ; SATA 2 Receive Data +	DP-I	-	-
A26	SATA2_RX-	SATA_RX2_N ; SATA 2 Receive Data -	DP-I	-	-
A27	BATLOW#	PM_BATLOW# ; Battery Low	I-3,3	PU 8k25 3,3V (S5)	-
A28	ATA_ACT#	ATA_LED# ; SATA LED	0-3,3	PU 10k 3,3V (S0)	int. PU 15k in ICH9 ; only active if PLTRST#=0
A29	AC_SYNC	HDA_SYNC ; HD Audio Sync	0-3,3	-	opt. for x4: PU 1k 3,3V(S0)
A30	AC_RST#	HDA_RST# ; HD Audio Reset	0-3,3	-	int. PD 20k in ICH9
A31	GND	Power Ground	PWR	-	-
A32	AC_BITCLK	HDA_BITCLK ; HD Audio Clock	0-3,3	int. PD 20k	active only in S3
A33	AC_SDOUT	HDA_SDOUT ; HD Audio Data	0-3,3	int. PD 20k	PU 1k 3,3V(S0)for X4
A34	BIOS_DISABLE#	BIOS_DISABLE#	I-3,3	-	-
A35	THRMTRIP#	EXT_THRMTRIP#	I/0-3,3	PU 10k 3,3V (S0)	-
A36	USB6-	USB6_N ; USB Data - Port6	DP-I/0	-	int. PD 15k in ICH9 ; 5V tolerant
A37	USB6+	USB6_P ; USB Data + Port6	DP-I/0	-	int. PD 15k in ICH9 ; 5V tolerant
A38	USB_6_7_OC#	USB_67_OC# ; USB OverCurrent Port 6/7	I-3,3	PU 10k 3,3V (S5)	-
A39	USB4-	USB4_N ; USB Data - Port4	DP-I/0	-	int. PD 15k in ICH9 ; 5V tolerant
A40	USB4+	USB4_P ; USB Data + Port4	DP-I/0	-	int. PD 15k in ICH9 ; 5V tolerant
A41	GND	Power Ground	PWR	-	-
A42	USB2-	USB2_N ; USB Data - Port2	DP-I/0	-	int. PD 15k in ICH9 ; 5V tolerant
A43	USB2+	USB2_P ; USB Data + Port2	DP-I/0	-	int. PD 15k in ICH9 ; 5V tolerant
A44	USB_2_3_OC#	USB_23_OC# ; USB OverCurrent Port 2/3	I-3,3	PU 10k 3,3V (S5)	-
A45	USB0-	USB0_N ; USB Data - Port0	DP-I/0	-	int. PD 15k in ICH9 ; 5V tolerant
A46	USB0+	USB0_P ; USB Data + Port0	DP-I/0	-	int. PD 15k in ICH9 ; 5V tolerant
A47	VCC_RTC	V_BAT	PWR 3V	-	-
A48	EXCDO_PERST#	EXCDO_PERST#;Express card reset	0-3,3	-	-
A49	EXCDO_CPPE#	EXCDO_CPPE# ; capable c. request	I-3,3	PU 10k 3,3V (S5)	-
A50	LPC_SERIRQ	LPC_SERIRQ ; Serial Interrupt Request	IO-3,3	PU 10k 3,3V (S0)	-
A51	GND	Power Ground	PWR	-	-
A52	PCIE_TX5+	opt. PCI Express lane 5 + Transmit	Nc	-	just available if no GbEthernet PHY is used.
A53	PCIE_TX5-	opt. PCI Express lane 5 - Transmit	Nc	-	just available if no GbEthernet PHY is used.
A54	GPIO	EXT_GPIO ; General Purpose Input 0	I-3,3	PU 10k 3,3V (S0)	-
A55	PCIE_TX4+	PCI Express lane 4 + Transmit	DP-0	-	-
A56	PCIE_TX4-	PCI Express lane 4 - Transmit	DP-0	-	-
A57	GND	Power Ground	PWR	-	-
A58	PCIE_TX3+	PCI Express lane 3 + Transmit	DP-0	-	-
A59	PCIE_TX3-	PCI Express lane 3 - Transmit	DP-0	-	-
A60	GND	Power Ground	PWR	-	-
A61	PCIE_TX2+	PCI Express lane 2 + Transmit	DP-0	-	-
A62	PCIE_TX2-	PCI Express lane 2 - Transmit	DP-0	-	-
A63	GPI1	EXT_GPI1 ; General Purpose Input 1	I-3,3	PU 10k 3,3V (S0)	-
A64	PCIE_TX1+	PCI Express lane 1 + Transmit	DP-0	-	-

A65	PCIE_TX1-	PCI Express lane 1 - Transmit	DP-0	-	-
A66	GND	Power Ground	PWR	-	-
A67	GPI2	EXT_GPI2 ; General Purpose Input 2	I-3,3	PU 10k 3,3V (S0)	-
A68	PCIE_TX0+	PCI Express lane 0 + Transmit	DP-0	-	-
A69	PCIE_TX0-	PCI Express lane 0 - Transmit	DP-0	-	-
A70	GND	Power Ground	PWR	-	-
A71	LVDS_A0+	LVDS_A_DATA0_P ; LVDS Channel A Data0+	DP-0	-	-
A72	LVDS_A0-	LVDS_A_DATA0_N ; LVDS Channel A Data0-	DP-0	-	-
A73	LVDS_A1+	LVDS_A_DATA1_P ; LVDS Channel A Data1+	DP-0	-	-
A74	LVDS_A1-	LVDS_A_DATA1_N ; LVDS Channel A Data1-	DP-0	-	-
A75	LVDS_A2+	LVDS_A_DATA2_P ; LVDS Channel A Data2+	DP-0	-	-
A76	LVDS_A2-	LVDS_A_DATA2_N ; LVDS Channel A Data2-	DP-0	-	-
A77	LVDS_VDD_EN	LVDS_VDD_EN ; LVDS Panel Power Control	O-3,3	PD 100k	-
A78	LVDS_A3+	LVDS_A_DATA3_P ; LVDS Channel A Data3+	DP-0	-	-
A79	LVDS_A3-	LVDS_A_DATA3_N ; LVDS Channel A Data3-	DP-0	-	-
A80	GND	Power Ground	PWR	-	-
A81	LVDS_A_CLK+	LVDS_A_CLK_P ; LVDS Channel A Clock+	DP-0	-	-
A82	LVDS_A_CLK-	LVDS_A_CLK_N ; LVDS Channel A Clock-	DP-0	-	-
A83	LVDS_I2C_CLK	LVDS_DDC_CLK ; JILI I2C Clock	I/O-3,3	PU 2k21 3,3V (s0)	-
A84	LVDS_I2C_DAT	LVDS_DDC_DATA ; JILI I2C Data	I/O-3,3	PU 2k21 3,3V (s0)	-
A85	GPI3	EXT_GPI3 ; General Purpose Input 3	I-3,3	PU 10k 3,3V (S0)	-
A86	KBD_RST#	KBD_RST# ; Keyboard Reset	I-3,3	PU 10k 3,3V (S0)	-
A87	KBD_A20GATE	KBD_A20GATE	I-3,3	PU 10k 3,3V (S0)	-
A88	PCIEO_CLK_REF+	CLK_PCIE_CON_P	DP-0	-	-
A89	PCIEO_CLK_REF-	CLK_PCIE_CON_N	DP-0	-	-
A90	GND	Power Ground	PWR	-	-
A91	RSVD	n.c.	Nc	-	-
A92	RSVD	n.c.	Nc	-	-
A93	GPO0	EXT_GPO0 ; General Purpose Output 0	O-3,3	PD 10k	-
A94	RSVD	n.c.	Nc	-	-
A95	RSVD	n.c.	Nc	-	-
A96	GND	Power Ground	PWR	-	-
A97	VCC_12V	12V VCC	PWR	-	8.5-18V
A98	VCC_12V	12V VCC	PWR	-	8.5-18V
A99	VCC_12V	12V VCC	PWR	-	8.5-18V
A100	GND	Power Ground	PWR	-	-
A101	VCC_12V	12V VCC	PWR	-	8.5-18V
A102	VCC_12V	12V VCC	PWR	-	8.5-18V
A103	VCC_12V	12V VCC	PWR	-	8.5-18V
A104	VCC_12V	12V VCC	PWR	-	8.5-18V
A105	VCC_12V	12V VCC	PWR	-	8.5-18V
A106	VCC_12V	12V VCC	PWR	-	8.5-18V
A107	VCC_12V	12V VCC	PWR	-	8.5-18V
A108	VCC_12V	12V VCC	PWR	-	8.5-18V
A109	VCC_12V	12V VCC	PWR	-	8.5-18V
A110	GND	Power Ground	PWR	-	-

## 7.3 Connector X1A Row B

Pin	Signal	Description	Type	Termination	Comment
B1	GND	Power Ground	PWR	-	-
B2	GBE0_ACT	GBE0_ACT# ; Ethernet Activity LED	OD	-	-
B3	LPC_FRAME#	LPC_FRAME# ; LPC Frame Indicator	I-3,3	-	-
B4	LPC_ADO	LPC_ADO ; LPC Address & DATA Bus	I/O-3,3	-	int. PU 20k in ICH9
B5	LPC_AD1	LPC_AD1 ; LPC Address & DATA Bus	I/O-3,3	-	int. PU 20k in ICH9
B6	LPC_AD2	LPC_AD2 ; LPC Address & DATA Bus	I/O-3,3	-	int. PU 20k in ICH9
B7	LPC_AD3	LPC_AD3 ; LPC Address & DATA Bus	I/O-3,3	-	int. PU 20k in ICH9
B8	LPC_DRQ0#	LPC_DRQ0# ; LPC Request 0	I-3,3	PU 10k 3,3V (S0)	int. PU 20k in ICH9
B9	LPC_DRQ1#	LPC_DRQ1# ; LPC Request 1	I-3,3	PU 10k 3,3V (S0)	int. PU 20k in ICH9
B10	LPC_CLK	CLK_LPC_33M_EXT ; 33MHz LPC clock	O-3,3	-	-
B11	GND	Power Ground	PWR	-	-
B12	PWRBTN#	EXT_PWRBTN# ; Power Button	I-3,3	PU 20k 3,3V (S5)	-
B13	SMB_CLK	SMB_CLK_EXT ; SMBUS Clock	O-3,3	PU 2k2 3,3V (S5)	-
B14	SMB_DAT	SMB_DATA_EXT ; SMBUS Data	IO-3,3	PU 2k2 3,3V (S5)	-
B15	SMB_ALERT#	SMB_ALERT# ; SMBUS Interrupt	IO-3,3	PU 1k0 3,3V (S5)	-
B16	SATA1_TX+	SATA_TX1_P ; SATA 1 Transmit Data +	DP-0	-	-
B17	SATA1_TX-	SATA_TX1_N ; SATA 1 Transmit Data -	DP-0	-	-
B18	SUS_STAT#	PM_SUS_STAT#	O-3,3	-	-
B19	SATA1_RX+	SATA_RX1_P ; SATA 1 Receive Data +	DP-I	-	-
B20	SATA1_RX-	SATA_RX1_N ; SATA 1 Receive Data -	DP-I	-	-
B21	GND	Power Ground	PWR	-	-
B22	SATA3_TX+	SATA_TX3_P ; SATA 3 Transmit Data +	DP-0	-	-
B23	SATA3_TX-	SATA_TX3_N ; SATA 3 Transmit Data -	DP-0	-	-
B24	PWR_OK	EXT_PWR_OK ; Power OK	I-3,3	-	-
B25	SATA3_RX+	SATA_RX3_P ; SATA 3 Receive Data +	DP-I	-	-
B26	SATA3_RX-	SATA_RX3_N ; SATA 3 Receive Data -	DP-I	-	-
B27	WDT	WDT ; Watch Dog Timer	O-3,3	-	-
B28	AC_SDIN2	HDA_SDIN2_ICH ; HD Audio Serial Input Data 2	I-3,3	-	int. PD 20k in ICH9
B29	AC_SDIN1	HDA_SDIN1_ICH ; HD Audio Serial Input Data 1	I-3,3	-	int. PD 20k in ICH9
B30	AC_SDINO	HDA_SDINO_ICH ; HD Audio Serial Input Data 0	I-3,3	-	int. PD 20k in ICH9
B31	GND	Power Ground	PWR	-	-
B32	SPKR	HDA_SPKR ; Speaker	O-3,3	-	int. PD 20k in ICH9
B33	I2C_CLK	I2C_CLK_EXT ; I2C clock	O-3,3	PU 2k21 3,3V (S0)	-
B34	I2C_DAT	I2C_DATA_EXT ; I2C data	I/O-3,3	PU 2k21 3,3V (S0)	-
B35	THRM#	PM_THRM# ; Over Temperature	O-3,3	PU 8k25 3,3V (S0)	-
B36	USB7-	USB7_N ; USB Data - Port7	DP-I/O	-	int. PD 15k in ICH9 ; 5V tolerant
B37	USB7+	USB7_P ; USB Data + Port7	DP-I/O	-	int. PD 15k in ICH9 ; 5V tolerant
B38	USB_4_5_OC#	USB_45_OC# ; USB OverCurrent Port 4/5	I-3,3	PU 10k 3,3V (S5)	-
B39	USB5-	USB5_N ; USB Data - Port5	DP-I/O	-	int. PD 15k in ICH9 ; 5V tolerant
B40	USB5+	USB5_P ; USB Data + Port5	DP-I/O	-	int. PD 15k in ICH9 ; 5V tolerant
B41	GND	Power Ground	PWR	-	-
B42	USB3-	USB3_N ; USB Data - Port3	DP-I/O	-	int. PD 15k in ICH9 ; 5V tolerant
B43	USB3+	USB3_P ; USB Data + Port3	DP-I/O	-	int. PD 15k in ICH9 ; 5V tolerant
B44	USB_0_1_OC#	USB_01_OC# ; USB OverCurrent Port 0/1	I-3,3	PU 10k 3,3V (S5)	-
B45	USB1-	USB1_N ; USB Data - Port1	DP-I/O	-	int. PD 15k in ICH9 ; 5V tolerant
B46	USB1+	USB1_P ; USB Data + Port1	DP-I/O	-	int. PD 15k in ICH9 ; 5V tolerant
B47	EXCD1_PERST#	EXCD1_PERST# ; Express card reset	O-3,3	-	-
B48	EXCD1_CPPE#	EXCD1_CPPE# ; capable c. request	I-3,3	PU 10k 3,3V (S5)	-
B49	SYS_RESET#	EXT_SYS_RESET# ; Reset Input	I-3,3	PU 10k 3,3V (S5)	-
B50	CB_RESET#	CB_RESET# ; Carrier board Reset	O-3,3	-	-
B51	GND	Power Ground	PWR	-	-
B52	PCIE_RX5+	opt. PCI Express lane 5 + Recieve	Nc	-	just available if no GbEthernet PHY is used.
B53	PCIE_RX5-	opt. PCI Express lane 5 - Recieve	Nc	-	just available if no GbEthernet PHY is used.
B54	GPO1	EXT_GPO1 ; General Purpose Output 1	O-3,3	PD 10k	-
B55	PCIE_RX4+	PCI Express lane 4 + Recieve	DP-I	-	available when ICH9-MDH or -R
B56	PCIE_RX4-	PCI Express lane 4 - Recieve	DP-I	-	available when ICH9-MDH or -R
B57	GPO2	EXT_GPO2 ; General Purpose Output 2	O-3,3	PD 10k	-
B58	PCIE_RX3+	PCI Express lane 3 + Recieve	DP-I	-	available when ICH9-MDH or -R
B59	PCIE_RX3-	PCI Express lane 3 - Recieve	DP-I	-	available when ICH9-MDH or -R
B60	GND	Power Ground	PWR	-	-
B61	PCIE_RX2+	PCI Express lane 2 + Recieve	DP-I	-	-
B62	PCIE_RX2-	PCI Express lane 2 - Recieve	DP-I	-	-

B63	GPO3	EXT_GPO3 ; General Purpose Output 3	0-3,3	PD 10k	-
B64	PCIE_RX1+	PCI Express lane 1 + Recieve	DP-I	-	-
B65	PCIE_RX1-	PCI Express lane 1 - Recieve	DP-I	-	-
B66	WAKE0#	PCIE_WAKE#	IO-3,3	PU 1k0 3,3V (S5)	-
B67	WAKE1#	WAKE1#	I-3,3	PU 10k 3,3V (S5)	-
B68	PCIE_RX0+	PCI Express lane 0 + Recieve	DP-I	-	-
B69	PCIE_RX0-	PCI Express lane 0 - Recieve	DP-I	-	-
B70	GND	Power Ground	PWR	-	-
B71	LVDS_B0+	LVDS_B_DATA0_P ; LVDS Channel B Data0+	DP-0	-	-
B72	LVDS_B0-	LVDS_B_DATA0_N ; LVDS Channel B Data0-	DP-0	-	-
B73	LVDS_B1+	LVDS_B_DATA1_P ; LVDS Channel B Data1+	DP-0	-	-
B74	LVDS_B1-	LVDS_B_DATA1_N ; LVDS Channel B Data1-	DP-0	-	-
B75	LVDS_B2+	LVDS_B_DATA2_P ; LVDS Channel B Data2+	DP-0	-	-
B76	LVDS_B2-	LVDS_B_DATA2_N ; LVDS Channel B Data2-	DP-0	-	-
B77	LVDS_B3+	LVDS_B_DATA3_P ; LVDS Channel B Data3+	DP-0	-	-
B78	LVDS_B3-	LVDS_B_DATA3_N ; LVDS Channel B Data3-	DP-0	-	-
B79	LVDS_BKLT_EN	LVDS_BKLT_CTRL ; Panel Backlight ON	0-3,3	PD 100k	-
B80	GND	Power Ground	PWR	-	-
B81	LVDS_B_CLK+	LVDS_B_CLK_P ; LVDS Channel B Clock+	DP-0	-	-
B82	LVDS_B_CLK-	LVDS_B_CLK_N ; LVDS Channel B Clock-	DP-0	-	-
B83	LVDS_BKLT_CTRL	LVDS_BKLT_CTRL ; Backlight Brightness Contr.	0-3,3	-	-
B84	VCC_5V_SBY	+V_STBY_ETX ; 5V Standby	PWR 5V (S5)	-	-
B85	VCC_5V_SBY	+V_STBY_ETX ; 5V Standby	PWR 5V (S5)	-	-
B86	VCC_5V_SBY	+V_STBY_ETX ; 5V Standby	PWR 5V (S5)	-	-
B87	VCC_5V_SBY	+V_STBY_ETX ; 5V Standby	PWR 5V (S5)	-	-
B88	RSVD	n.c.	nc	-	-
B89	VGA_RED	CRT_RED ; Analog Video RGB-RED	OA	PD 150R	-
B90	GND	Power Ground	PWR	-	-
B91	VGA_GRN	CRT_GREEN ; Analog Video RGB-GREEN	OA	PD 150R	-
B92	VGA_BLU	CRT_BLUE ; Analog Video RGB-BLUE	OA	PD 150R	-
B93	VGA_HSYNC	CRT_HSYNC ; Analog Video H-Sync	0-3,3	-	-
B94	VGA_VSYNC	CRT_VSYNC ; Analog Video V-Sync	0-3,3	-	-
B95	VGA_I2C_CLK	CRT_DDC_CLK ; Display Data Channel Clock	I/O-5	PU 2k21 5V (S0)	-
B96	VGA_I2C_DAT	CRT_DDC_DATA ; Display Data Channel Data	I/O-5	PU 2k21 5V (S0)	-
B97	TV_DAC_A	TV_DACA_CVBS ; Composite CVBS	OA	PD 150R	-
B98	TV_DAC_B	TV_DADB_Y ; TV Luminance Signal	OA	PD 150R	-
B99	TV_DAC_C	TV_DADC_C ; TV Chrominance Signal	OA	PD 150R	-
B100	GND	Power Ground	PWR	-	-
B101	VCC_12V	12V VCC	PWR	-	8.5-18V
B102	VCC_12V	12V VCC	PWR	-	8.5-18V
B103	VCC_12V	12V VCC	PWR	-	8.5-18V
B104	VCC_12V	12V VCC	PWR	-	8.5-18V
B105	VCC_12V	12V VCC	PWR	-	8.5-18V
B106	VCC_12V	12V VCC	PWR	-	8.5-18V
B107	VCC_12V	12V VCC	PWR	-	8.5-18V
B108	VCC_12V	12V VCC	PWR	-	8.5-18V
B109	VCC_12V	12V VCC	PWR	-	8.5-18V
B110	GND	Power Ground	PWR	-	-



## 7.4 Connector X1B Row C

Pin	Signal	Description	Type	Termination	Comment
C1	GND	Power Ground	PWR	-	-
C2	IDE_D7	IDE Data Bus	I/O-5T	PD 10k	-
C3	IDE_D6	IDE Data Bus	I/O-5T	-	-
C4	IDE_D3	IDE Data Bus	I/O-5T	-	-
C5	IDE_D15	IDE Data Bus	I/O-5T	-	-
C6	IDE_D8	IDE Data Bus	I/O-5T	-	-
C7	IDE_D9	IDE Data Bus	I/O-5T	-	-
C8	IDE_D2	IDE Data Bus	I/O-5T	-	-
C9	IDE_D13	IDE Data Bus	I/O-5T	-	-
C10	IDE_D1	IDE Data Bus	I/O-5T	-	-
C11	GND	Power Ground	PWR	-	-
C12	IDE_D14	IDE Data Bus	I/O-5T	-	-
C13	IDE_IORDY	IDE I/O Ready	I/O-5T	PU 4k7 3,3V (S0)	-
C14	IDE_IOR#	IDE I/O Read	I/O-3,3	-	-
C15	PCI_PME#	PCI Power Management Event	I/O-3,3	-	int. PU 20k in ICH9
C16	PCI_GNT2#	PCI Bus Grant 2	0-3,3	-	int. PU 20k in ICH9 (if PCIRST#=0 AND PWROK=1)
C17	PCI_REQ2#	PCI Bus Request 2	I-5T	PU 8k2 3,3V (S0)	-
C18	PCI_GNT1#	PCI Bus Grant 1	0-3,3	-	int. PU 20k in ICH9 (if PCIRST#=0 AND PWROK=1)
C19	PCI_REQ1#	PCI Bus Request 1	I-5T	PU 8k2 3,3V (S0)	-
C20	PCI_GNT0#	PCI Bus Grant 0	0-3,3	PD 1k0	int. PU 20k in ICH9 (if PCIRST#=0 AND PWROK=1)
C21	GND	Power Ground	PWR	-	-
C22	PCI_REQ0#	PCI Bus Request 0	I-5T	PU 8k2 3,3V (S0)	-
C23	PCI_RST#	PCI Bus Reset	0-3,3	-	-
C24	PCI_ADO	PCI Address & Data Bus line	I/O-5T	-	-
C25	PCI_AD2	PCI Address & Data Bus line	I/O-5T	-	-
C26	PCI_AD4	PCI Address & Data Bus line	I/O-5T	-	-
C27	PCI_AD6	PCI Address & Data Bus line	I/O-5T	-	-
C28	PCI_AD8	PCI Address & Data Bus line	I/O-5T	-	-
C29	PCI_AD10	PCI Address & Data Bus line	I/O-5T	-	-
C30	PCI_AD12	PCI Address & Data Bus line	I/O-5T	-	-
C31	GND	Power Ground	PWR	-	-
C32	PCI_AD14	PCI Address & Data Bus line	I/O-5T	-	-
C33	PCI_C/BE1#	PCI Bus Cmd Byte enables 1	I/O-5T	-	-
C34	PCI_PERR#	PCI Bus Grant Error	I/O-5T	PU 8k2 3,3V (S0)	-
C35	PCI_LOCK#	PCI Bus Lock	I/O-5T	PU 8k2 3,3V (S0)	-
C36	PCI_DEVSEL#	PCI Bus Device Select	I/O-5T	PU 8k2 3,3V (S0)	-
C37	PCI_IRDY#	PCI Bus Initiator Ready	I/O-5T	PU 8k2 3,3V (S0)	-
C38	PCI_C/BE2#	PCI Bus Cmd Byte enables 2	I/O-5T	-	-
C39	PCI_AD17	PCI Address & Data Bus line	I/O-5T	-	-
C40	PCI_AD19	PCI Address & Data Bus line	I/O-5T	-	-
C41	GND	Power Ground	PWR	-	-
C42	PCI_AD21	PCI Address & Data Bus line	I/O-5T	-	-
C43	PCI_AD23	PCI Address & Data Bus line	I/O-5T	-	-
C44	PCI_C/BE3#	PCI Bus Cmd Byte enables 3	I/O-5T	-	-
C45	PCI_AD25	PCI Address & Data Bus line	I/O-5T	-	-
C46	PCI_AD27	PCI Address & Data Bus line	I/O-5T	-	-
C47	PCI_AD29	PCI Address & Data Bus line	I/O-5T	-	-
C48	PCI_AD31	PCI Address & Data Bus line	I/O-5T	-	-
C49	PCI_IRQA#	PCI Bus Interrupt Request A	I-5T	PU 8k2 3,3V (S0)	-
C50	PCI_IRQB#	PCI Bus Interrupt Request B	I-5T	PU 8k2 3,3V (S0)	-
C51	GND	Power Ground	PWR	-	-
C52	PEG_RX0+	PCIexpress Graphics Receive + (0)	DP-I	-	-
C53	PEG_RX0-	PCIexpress Graphics Receive - (0)	DP-I	-	-
C54	TYPE0#	n.c. for type 2 module	nc	-	-
C55	PEG_RX1+	PCIexpress Graphics Receive + (1)	DP-I	-	-
C56	PEG_RX1-	PCIexpress Graphics Receive - (1)	DP-I	-	-
C57	TYPE1#	n.c. for type 2 module	nc	-	-
C58	PEG_RX2+	PCIexpress Graphics Receive + (2)	DP-I	-	-
C59	PEG_RX2-	PCIexpress Graphics Receive - (2)	DP-I	-	-
C60	GND	Power Ground	PWR	-	-
C61	PEG_RX3+	PCIexpress Graphics Receive + (3)	DP-I	-	-
C62	PEG_RX3-	PCIexpress Graphics Receive - (3)	DP-I	-	-
C63	RSVD	n.c.	nc	-	-
C64	RSVD	n.c.	nc	-	-

C65	PEG_RX4+	PCIexpress Graphics Recieve + (4)	DP-I	-	-
C66	PEG_RX4-	PCIexpress Graphics Recieve - (4)	DP-I	-	-
C67	RSVD	n.c.	nc	-	-
C68	PEG_RX5+	PCIexpress Graphics Recieve + (5)	DP-I	-	-
C69	PEG_RX5-	PCIexpress Graphics Recieve - (5)	DP-I	-	-
C70	GND	Power Ground	PWR	-	-
C71	PEG_RX6+	PCIexpress Graphics Recieve + (6)	DP-I	-	-
C72	PEG_RX6-	PCIexpress Graphics Recieve - (6)	DP-I	-	-
C73	SDVO_DATA	SDVO_CTRLDATA	I/O-3,3	-	opt. PU 2k21 3,3V (S0) = enable SDVO/HDMI/DP interface
C74	PEG_RX7+	PCIexpress Graphics Recieve + (7)	DP-I	-	-
C75	PEG_RX7-	PCIexpress Graphics Recieve - (7)	DP-I	-	-
C76	GND	Power Ground	PWR	-	-
C77	RSVD	n.c.	nc	-	-
C78	PEG_RX8+	PCIexpress Graphics Recieve + (8)	DP-I	-	-
C79	PEG_RX8-	PCIexpress Graphics Recieve - (8)	DP-I	-	-
C80	GND	Power Ground	PWR	-	-
C81	PEG_RX9+	PCIexpress Graphics Recieve + (9)	DP-I	-	-
C82	PEG_RX9-	PCIexpress Graphics Recieve - (9)	DP-I	-	-
C83	RSVD	n.c.	nc	-	-
C84	GND	Power Ground	PWR	-	-
C85	PEG_RX10+	PCIexpress Graphics Recieve + (10)	DP-I	-	-
C86	PEG_RX10-	PCIexpress Graphics Recieve - (10)	DP-I	-	-
C87	GND	Power Ground	PWR	-	-
C88	PEG_RX11+	PCIexpress Graphics Recieve + (11)	DP-I	-	-
C89	PEG_RX11-	PCIexpress Graphics Recieve - (11)	DP-I	-	-
C90	GND	Power Ground	PWR	-	-
C91	PEG_RX12+	PCIexpress Graphics Recieve + (12)	DP-I	-	-
C92	PEG_RX12-	PCIexpress Graphics Recieve - (12)	DP-I	-	-
C93	GND	Power Ground	PWR	-	-
C94	PEG_RX13+	PCIexpress Graphics Recieve + (13)	DP-I	-	-
C95	PEG_RX13-	PCIexpress Graphics Recieve - (13)	DP-I	-	-
C96	GND	Power Ground	PWR	-	-
C97	RSVD	n.c.	nc	-	-
C98	PEG_RX14+	PCIexpress Graphics Recieve + (14)	DP-I	-	-
C99	PEG_RX14-	PCIexpress Graphics Recieve - (14)	DP-I	-	-
C100	GND	Power Ground	PWR	-	-
C101	PEG_RX15+	PCIexpress Graphics Recieve + (15)	DP-I	-	-
C102	PEG_RX15-	PCIexpress Graphics Recieve - (15)	DP-I	-	-
C103	GND	Power Ground	PWR	-	-
C104	VCC_12V	12V VCC	PWR	-	8.5-18V
C106	VCC_12V	12V VCC	PWR	-	8.5-18V
C105	VCC_12V	12V VCC	PWR	-	8.5-18V
C107	VCC_12V	12V VCC	PWR	-	8.5-18V
C108	VCC_12V	12V VCC	PWR	-	8.5-18V
C109	VCC_12V	12V VCC	PWR	-	8.5-18V
C110	GND	Power Ground	PWR	-	-

## 7.5 Connector X1B Row D

Pin	Signal	Description	Type	Termination	Comment
D1	GND	Power Ground	PWR	-	-
D2	IDE_D5	IDE Data Bus	I/O-5T	-	-
D3	IDE_D10	IDE Data Bus	I/O-5T	-	-
D4	IDE_D11	IDE Data Bus	I/O-5T	-	-
D5	IDE_D12	IDE Data Bus	I/O-5T	-	-
D6	IDE_D4	IDE Data Bus	I/O-5T	-	-
D7	IDE_D0	IDE Data Bus	I/O-5T	-	-
D8	IDE_REQ	IDE Data Bus	I/O-5T	PD 5k62	-
D9	IDE_IOW#	IDE IO Write	0-3,3	-	-
D10	IDE_ACK#	IDE DMA Acknowledge	0-3,3	-	-
D11	GND	Power Ground	PWR	-	-
D12	IDE_IRQ	IDE Interrupt Request	I-5T	PD 10k	-
D13	IDE_A0	IDE Address Bus	0-3,3	-	-
D14	IDE_A1	IDE Address Bus	0-3,3	-	-
D15	IDE_A2	IDE Address Bus	0-3,3	-	-
D16	IDE_CS1#	IDE Chip Select Channel 0	0-3,3	-	-
D17	IDE_CS3#	IDE Chip Select Channel 1	0-3,3	-	-
D18	IDE_RESET#	IDE Hard Drive Reset	0-3,3	-	int. PU 31k in PATA bridge ; not 5V tolerant
D19	PCI_GNT3#	PCI Bus Grant 3	0-3,3	-	int. PU 20k in ICH9 (if PCIRST#=0 AND PWROK=1)
D20	PCI_REQ3#	PCI Bus Request 0	I-5T	PU 8k2 3,3V (S0)	-
D21	GND	Power Ground	PWR	-	-
D22	PCI_AD1	PCI Address & Data Bus line	I/O-5T	-	-
D23	PCI_AD3	PCI Address & Data Bus line	I/O-5T	-	-
D24	PCI_AD5	PCI Address & Data Bus line	I/O-5T	-	-
D25	PCI_AD7	PCI Address & Data Bus line	I/O-5T	-	-
D26	PCI_C/BEO#	PCI Bus Command and Byte enables 0	I/O-5T	-	-
D27	PCI_AD9	PCI Address & Data Bus line	I/O-5T	-	-
D28	PCI_AD11	PCI Address & Data Bus line	I/O-5T	-	-
D29	PCI_AD13	PCI Address & Data Bus line	I/O-5T	-	-
D30	PCI_AD15	PCI Address & Data Bus line	I/O-5T	-	-
D31	GND	Power Ground	PWR	-	-
D32	PCI_PAR	PCI Bus Parity	I/O-5T	-	-
D33	PCI_SERR#	PCI Bus System Error	I/O-5T	PU 8k2 3,3V (S0)	-
D34	PCI_STOP#	PCI Bus Stop	I/O-5T	PU 8k2 3,3V (S0)	-
D35	PCI_TRDY#	PCI Bus Target Ready	I/O-5T	PU 8k2 3,3V (S0)	-
D36	PCI_FRAME#	PCI Bus Cycle Frame	I/O-5T	PU 8k2 3,3V (S0)	-
D37	PCI_AD16	PCI Address & Data Bus line	I/O-5T	-	-
D38	PCI_AD18	PCI Address & Data Bus line	I/O-5T	-	-
D39	PCI_AD20	PCI Address & Data Bus line	I/O-5T	-	-
D40	PCI_AD22	PCI Address & Data Bus line	I/O-5T	-	-
D41	GND	Power Ground	PWR	-	-
D42	PCI_AD24	PCI Address & Data Bus line	I/O-5T	-	-
D43	PCI_AD26	PCI Address & Data Bus line	I/O-5T	-	-
D44	PCI_AD28	PCI Address & Data Bus line	I/O-5T	-	-
D45	PCI_AD30	PCI Address & Data Bus line	I/O-5T	-	-
D46	PCI_IRQC#	PCI Bus Interrupt Request C	I-5T	PU 8k2 3,3V (S0)	-
D47	PCI_IRQD#	PCI Bus Interrupt Request D	I-5T	PU 8k2 3,3V (S0)	-
D48	PCI_CLKRUN#	PCI Clock Run	I-5T	PU 8k25 3,3V (S0)	-
D49	PCI_M66EN	n.c.	nc	-	-
D50	PCI_CLK	CLK_PCI_33M_EXT ; PCI Clock 33MHz	0-3,3	-	-
D51	GND	Power Ground	PWR	-	-
D52	PEG_TX0+	PCIexpress Graphics Transmit + (0)	DP-0	-	-
D53	PEG_TX0-	PCIexpress Graphics Transmit - (0)	DP-0	-	-
D54	PEG_LANE_RV#	PCIexpress Graphics Lane Reversal	I-3,3	-	-
D55	PEG_TX1+	PCIexpress Graphics Transmit + (1)	DP-0	-	-
D56	PEG_TX1-	PCIexpress Graphics Transmit - (1)	DP-0	-	-
D57	TYPE2#	n.c. for type 2 module	nc	-	-
D58	PEG_TX2+	PCIexpress Graphics Transmit + (2)	DP-0	-	-
D59	PEG_TX2-	PCIexpress Graphics Transmit - (2)	DP-0	-	-
D60	GND	Power Ground	PWR	-	-
D61	PEG_TX3+	PCIexpress Graphics Transmit + (3)	DP-0	-	-
D62	PEG_TX3-	PCIexpress Graphics Transmit - (3)	DP-0	-	-
D63	RSVD	-	nc	-	-
D64	RSVD	-	nc	-	-

D65	PEG_TX4+	PCIexpress Graphics Transmit + (4)	DP-0	-	-
D66	PEG_TX4-	PCIexpress Graphics Transmit - (4)	DP-0	-	-
D67	GND	Power Ground	PWR	-	-
D68	PEG_TX5+	PCIexpress Graphics Transmit + (5)	DP-0	-	-
D69	PEG_TX5-	PCIexpress Graphics Transmit - (5)	DP-0	-	-
D70	GND	Power Ground	PWR	-	-
D71	PEG_TX6+	PCIexpress Graphics Transmit + (6)	DP-0	-	-
D72	PEG_TX6-	PCIexpress Graphics Transmit - (6)	DP-0	-	-
D73	SDVO_CLK	SDVO_CTRLCLK I	0-3,3	-	-
D74	PEG_TX7+	PCIexpress Graphics Transmit + (7)	DP-0	-	-
D75	PEG_TX7-	PCIexpress Graphics Transmit - (7)	DP-0	-	-
D76	GND	Power Ground	PWR	-	-
D77	IDE_CBLID	IDE_CBLID# ; IDE cable type detect	I/0-3,3	-	opt. int. PU in IDE flash
D78	PEG_TX8+	PCIexpress Graphics Transmit + (8)	DP-0	-	-
D79	PEG_TX8-	PCIexpress Graphics Transmit - (8)	DP-0	-	-
D80	GND	Power Ground	PWR	-	-
D81	PEG_TX9+	PCIexpress Graphics Transmit + (9)	DP-0	-	-
D82	PEG_TX9-	PCIexpress Graphics Transmit - (9)	DP-0	-	-
D83	RSVD	n.c.	nc	-	-
D84	GND	Power Ground	PWR	-	-
D85	PEG_TX10+	PCIexpress Graphics Transmit + (10)	DP-0	-	-
D86	PEG_TX10-	PCIexpress Graphics Transmit - (10)	DP-0	-	-
D87	GND	Power Ground	PWR	-	-
D88	PEG_TX1	1+ PCIexpress Graphics Transmit + (11)	DP-0	-	-
D89	PEG_TX11-	PCIexpress Graphics Transmit - (11)	DP-0	-	-
D90	GND	Power Ground	PWR	-	-
D91	PEG_TX12+	PCIexpress Graphics Transmit + (12)	DP-0	-	-
D92	PEG_TX12-	PCIexpress Graphics Transmit - (12)	DP-0	-	-
D93	GND	Power Ground	PWR	-	-
D94	PEG_TX13+	PCIexpress Graphics Transmit + (13)	DP-0	-	-
D95	PEG_TX13-	PCIexpress Graphics Transmit - (13)	DP-0	-	-
D96	GND	Power Ground	PWR	-	-
D97	PEG_ENABLE#	PCIexpress Graphics Enable	I-3,3	PU 10k 3,3V (S0)	-
D98	PEG_TX14+	PCIexpress Graphics Transmit + (14)	DP-0	-	-
D99	PEG_TX14-	PCIexpress Graphics Transmit - (14)	DP-0	-	-
D100	GND	Power Ground	PWR	-	-
D101	PEG_TX15+	PCIexpress Graphics Transmit + (15)	DP-0	-	-
D102	PEG_TX15-	PCIexpress Graphics Transmit - (15)	DP-0	-	-
D103	GND	Power Ground	PWR	-	-
D104	VCC_12V	12V VCC	PWR	-	8.5-18V
D105	VCC_12V	12V VCC	PWR	-	8.5-18V
D106	VCC_12V	12V VCC	PWR	-	8.5-18V
D107	VCC_12V	12V VCC	PWR	-	8.5-18V
D108	VCC_12V	12V VCC	PWR	-	8.5-18V
D109	VCC_12V	12V VCC	PWR	-	8.5-18V
D110	GND	Power Ground	PWR	-	-



The termination resistors in these tables are already mounted on the ETXexpress® board. Refer to the design guide for information about additional termination resistors.

## 8 BIOS Operation

The module is equipped with AMI® CORE8 BIOS, which is located in an onboard SPI/LPC flash memory. You can update the BIOS using a Flash utility.

### 8.1 Determining the BIOS Version

To determine the AMI® BIOS version, immediately press the Pause key on your keyboard as soon as you see the following text display in the upper left corner of your screen:

- » AMIBIOS © 2006 American Megatrends, Inc.
- » BIOS Date: mm/dd/yyyy hh:mm:ss Ver: xx.xx.xx
- » Kontron® BIOS Version <CNTG / CNT2 / CNTXRXXX
- » Copyright 2002-2011 Kontron Embedded Modules GmbH

### 8.2 BIOS Update

Kontron provides continuous BIOS updates for Computer-on-Modules. The updates are provided for download on <http://emdcustomersection.kontron.com> with a detailed change description within the according Product Change Notification (PCN). Please register for EMD Customer Section to get access to BIOS downloads and PCN service.

Modules with BIOS Region/Setup only inside the flash can be updated with AFU utilities (usually 1-3MB BIOS binary file size) directly. Modules with Intel® Management Engine, Ethernet, Flash Descriptor and other options additionally to the BIOS Region (usually 4-8MB BIOS binary file size) requires a different update process with Intel Flash Utility FPT and a wrapper to backup and restore configurations and the MAC address. Therefore it is strongly recommended to use the batch file inside the BIOS download package available on EMD Customer Section.

- » Boot the module to DOS/EFI Shell with access to the BIOS image and Firmware Update Utility provided on EMD Customer Section
- » Execute Flash.bat in DOS or Flash.nsh in EFI Shell



Any modification of the update process may damage your module!

## 8.3 Setup Guide

The AMIBIOS Setup Utility changes system behavior by modifying the BIOS configuration. The setup program uses a number of menus to make changes and turn features on or off.

Functional keystrokes in POST:

Key	Function
DEL	Enter Setup
F2	Enter Setup
F11	Boot Menu
CTRL+HOME	Initiate BIOS Recovery

### 8.3.1 Start AMI® BIOS Setup Utility

To start the AMI® BIOS setup utility, press <DEL> when the following string appears during bootup.

**Press <DEL> to enter Setup**

The Info Menu then appears.

The Setup Screen is composed of several sections:

Setup Screen	Location	Function
Menu Bar	Top	Lists and selects all top level menus.
Legend Bar	Right side Bottom	Lists setup navigation keys.
Item Specific Help Window	Right side Top	Help for selected item.
Menu Window	Left Center	Selection fields for current menu.

## Menu Bar

The menu bar at the top of the window lists different menus. Use the left/right arrow keys to make a selection.

## Legend Bar

Use the keys listed in the legend bar on the bottom to make your selections or exit the current menu. The table below describes the legend keys and their alternates.

Key	Function
<F1> or <Alt-H>	General Help window.
<Esc>	Exit menu.
← or → Arrow key	Select a menu.
↑ or ↓ Arrow key	Select fields in current menu.
<Home> or <End>	Move cursor to top or bottom of current window.
<PgUp> or <PgDn>	Move cursor to next or previous page.
<F9>	Load the default configuration values for this menu.
<F10>	Save and exit.
<Enter>	Execute command or select submenu.
<Alt-R>	Refresh screen.

## Selecting an Item

Use the ↑ or ↓ key to move the cursor to the field you want. Then use the + and – keys to select a value for that field. The Save Value commands in the Exit menu save the values displayed in all the menus.

## Displaying Submenus

Use the ← or → key to move the cursor to the submenu you want. Then press <Enter>. A pointer (▶) marks all submenus.

## Item Specific Help Window

The Help window on the right side of each menu displays the Help text for the selected item. It updates as you move the cursor to each field.

## General Help Window

Pressing <F1> or <Alt-F1> on a menu brings up the General Help window that describes the legend keys and their alternates. Press <Esc> to exit the General Help window.

## 8.4 BIOS Setup

### 8.4.1 Main Menu

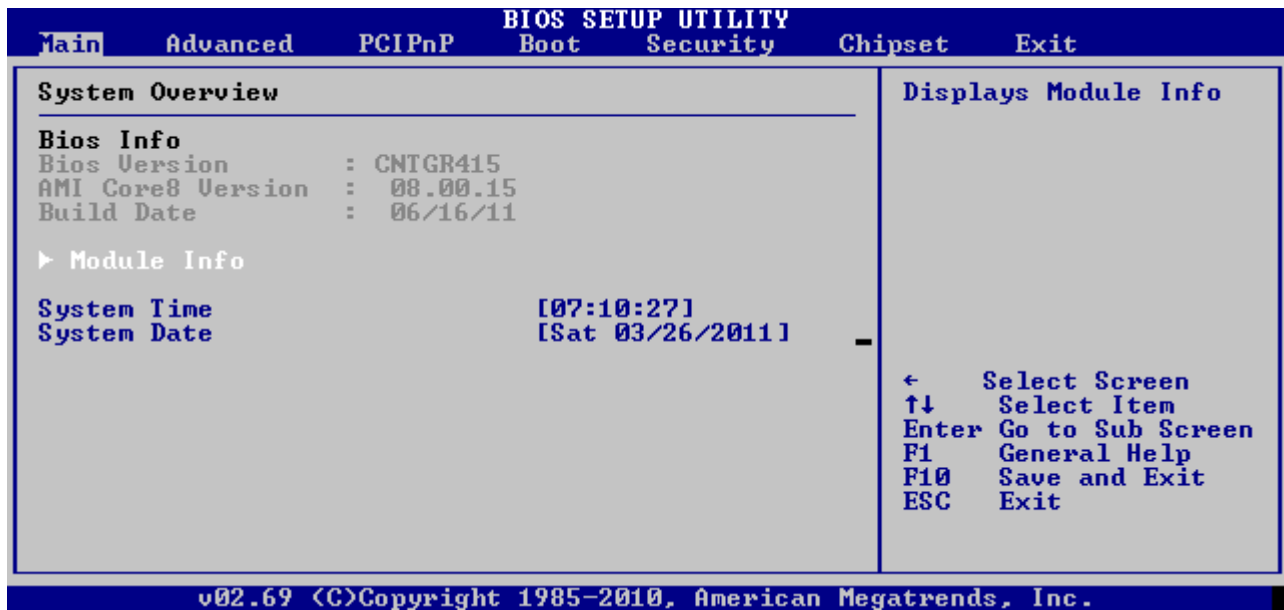

Feature	Option	Description
System Time	[hh:mm:ss]	<Tab>, <Shift-Tab>, or <Enter> selects field
System Date	[mm-dd-yyyy]	<Tab>, <Shift-Tab>, or <Enter> selects field



## 8.4.2 Module Info

Module Info	
<b>Main</b>	
<b>Module Info</b> Board Name : ETXexpress-PC Board Class : CPU Serial Number : CNTGBWD0N0331 Manufacturing Date : 5/25/2009 Hardware Revision : 0.0 Boot Counter : 116  <b>Processor</b> Intel(R) Core(TM)2 Duo CPU L9400 @ 1.86GHz Speed :1866MHz Count :1  ▶ Module Component Steppings ▶ Module Software Revisions ▶ Current LUDS Configuration ▶ Memory Module Information	<b>Displays Module Component Steppings</b>           ← Select Screen ↑↓ Select Item Enter Go to Sub Screen F1 General Help F10 Save and Exit ESC Exit
v02.61 (C)Copyright 1985-2006, American Megatrends, Inc.	

## Module Component Steppings

Module Component Steppings	
<b>Main</b>	
<b>Module Component Steppings</b> CPU Stepping : <0x9295D3> C0 NB Stepping : <0x07> B3 SB Stepping : <0x03> A3 WD PIC Revision : 1.3 KCPLD TYPE : Released Version KCPLD REV : CNTGP208.0008	← Select Screen ↑↓ Select Item F1 General Help F10 Save and Exit ESC Exit
v02.61 (C)Copyright 1985-2006, American Megatrends, Inc.	

## Module Software Revisions

Module Software Revisions	
<b>Main</b>	
<b>Module Software Revisions</b>	
Bios Version	: CNTGR415
Bios Build ID	: 0.STABLE.548
CPU Microcode Rev	: 15<0x0F>
MRC Version	: 02.92
GBE OPROM Version	: 1.3.27
Intel Raid Version	: N/A
<b>JIDA32</b>	
Handler Revision	: 1.3.90
Loader Revision	: 1.1
JDA Revision	: 1.12
UBIOS Revision	: 1744
JILI Core Revision	: 1.2.1
JRC Revision	: 132
	← Select Screen ↑↓ Select Item F1 General Help F10 Save and Exit ESC Exit
v02.69 <C>Copyright 1985-2010, American Megatrends, Inc.	

## Current LVDS Configuration

Current LVDS Configuration	
<b>Main</b>	
<b>Current LVDS Configuration</b>	
Data Source	: Fixed Mode
Resolution	: 640x480
Color Depth	: 18Bit
Channel Count	: Single Channel
Dithering	: Enabled
	← Select Screen ↑↓ Select Item F1 General Help F10 Save and Exit ESC Exit
v02.61 <C>Copyright 1985-2006, American Megatrends, Inc.	

## Memory Module Information

System Memory	
<b>Main</b>	
<b>Current Configuration</b> FSB Frequency : 1066 Dual Channel Mode : Interleaved DRAM Frequency : 1066 Mhz CAS# Latency <CL> : 7 RAS# to CAS# Delay <trCD> : 7 RAS# Precharge <trP> : 7 CycleTime <trAS> : 20 <b>System Memory</b> Size : 3997MB <b>Memory Module Information</b> ▶ SLO1 1 ▶ SLO1 2	<b>Displays Memory Module Information</b>  ← Select Screen ↑↓ Select Item Enter Go to Sub Screen F1 General Help F10 Save and Exit ESC Exit
v02.61 <C>Copyright 1985-2006, American Megatrends, Inc.	

## Slot 1

Main	
<b>SLO1 1</b> Technoligy : DDR3 SDRAM Manufacturer : Qimonda DRAM Manufacture : Qimonda Manufacture Loc : 45 Manufacture Rev : 1506 Partnum : MSH1GS14A S/N : 10AC1749 Manufacture Date : Week 35 /Year 08 Capacity : 1024MB Frequency : DDR3-1066F, PC3-8500 533Mhz SPD Revision : 0.8 CRC : VALID	← Select Screen ↑↓ Select Item F1 General Help F10 Save and Exit ESC Exit
v02.61 <C>Copyright 1985-2006, American Megatrends, Inc.	

### 8.4.3 Advanced Menu

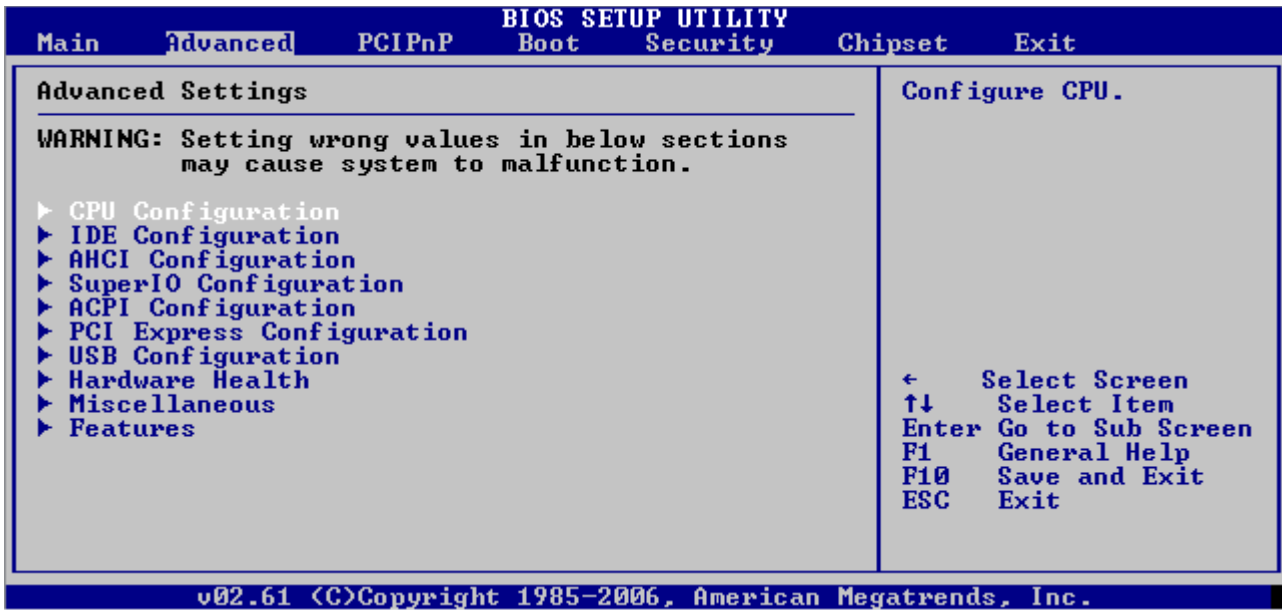

## CPU Configuration

**BIOS SETUP UTILITY**

**Advanced**

---

**Configure advanced CPU settings**  
Module Version:3F.11

```

Manufacturer: Intel
Intel(R) Core(TM)2 Duo CPU      L9400  @ 1.86GHz
Frequency      :1.86GHz
FSB Speed      :1068MHz
Cache L1       :64 KB
Cache L2       :6144 KB
Ratio Actual Value:7

Hardware Prefetcher           [Enabled]
Adjacent Cache Line Prefetch  [Enabled]
Max CPUID Value Limit         [Disabled]
Intel(R) Virtualization Tech  [Enabled]
Execute-Disable Bit Capability [Enabled]
DTS-based Thermal Management [Enabled]
DTS Calibration               [Enabled]
Intel(R) SpeedStep(tm) tech   [Enabled]
Intel(R) C-STATE tech         [Enabled]
Enhanced C-States             [Enabled]
ACPI T-STATE tech            [Enabled]
CPU Performance               [High]
    
```

For UP platforms, leave it enabled. For DP/MP servers, it may use to tune performance to the specific application.

← Select Screen  
 ↑↓ Select Item  
 +- Change Option  
 F1 General Help  
 F10 Save and Exit  
 ESC Exit

---

v02.69 (C)Copyright 1985-2010, American Megatrends, Inc.

Feature	Option	Description
Hardware Prefetcher	Enabled Disabled	For UP platforms, leave it enabled. For DP/MP servers, it may use to tune performance to the specific application.
Adjacent Cache Line Prefetch	Enabled Disabled	For UP platforms, leave it enabled. For DP/MP servers, it may use to tune performance to the specific application.
Max CPUID Value Limit	Disabled Enabled	Disabled for WindowsXP
Intel® Virtualization Tech	Enabled Disabled	When enabled, a VMM can utilize the additional HW Caps, provided by Intel® Virtualization Tech. Note: A full reset is required to change the setting.
Execute-Disable Bit Capability	Enabled Disabled	When disabled, force the XD feature flag to always return 0
DTS-based Thermal Management	Enabled Disabled	Enable/Disable Thermal Management utilizing the CPU's Digital Thermal Sensor
DTS Calibration	Enabled Disabled	Enables and Disables the Calibration function of the CPU's Digital Thermal Sensor
Intel® SpeedStep™	Enabled Disabled	Enables and Disables the SpeedStep power management feature
Intel® C-State Technology	Enabled Disabled	Enables and Disables the C - States. If enabled, the CPU is set to C2 - C4 state in idle mode
Enhanced C-State Modes	Enabled Disabled	CPU idle is set to enhanced C-states, when enabled
ACPI T-STATE tech	Enabled Disabled	Enable or Disable ACPI T-State technology
CPU Performance	High Middle Low	Select CPU Performance after POST

The CPU Performance relates to the used processor on the . The following table shows you the selected speed in the 3 performance stages.

Product Number	Processor	High	Middle	Low
38008-0000-12-1	Celeron® M722	1,2GHz	1,2GHz	1,2GHz
38008-0000-12-2	SU9300	1,2GHz	1,2GHz	1,2GHz
38008-0000-12-3	Celeron® M723	1,2GHz	1,2GHz	1,2GHz
38008-0000-19-2	SL9400	1,86GHz	1,6GHz	1,6GHz
38008-0000-23-2	SP9300	2,26GHz	1,93GHz	1,6GHz
38009-0000-20-0	Celeron® 575	2,0GHz	2,0GHz	2,0GHz
38009-0000-19-2	T3100	1,9GHz	1,9GHz	1,9GHz
38009-0000-23-2	P8400	2,26GHz	1,93GHz	1,6GHz
38009-0000-25-2	T9400	2,53GHz	2,07GHz	1,6GHz

## IDE Configuration

BIOS SETUP UTILITY		
Advanced		
IDE Configuration		Options
SATA#1 Configuration	[Enabled]	Disabled
Configure SATA#1 as	[IDE Compatible]	Enabled
SATA#2 Configuration	[Enhanced]	
▶ Primary IDE Master	: [Not Detected]	
▶ Secondary IDE Master	: [Not Detected]	
▶ Third IDE Master	: [Not Detected]	
▶ Fourth IDE Master	: [Not Detected]	
Hard Disk Write Protect	[Disabled]	← Select Screen
IDE Detect Time Out <Sec>	[ 1 ]	↑↓ Select Item
ATA<PI> 80Pin Cable Detection	[Host & Device]	+− Change Option
		F1 General Help
		F10 Save and Exit
		ESC Exit
v02.69 <C>Copyright 1985-2010, American Megatrends, Inc.		

Feature	Option	Description
SATA #1 Configuration	Disabled Enabled	Enables or disables the SATA interface.
Configure SATA#1 as	IDE Compatible RAID AHCI IDE Enhanced	Selects the mode for SATA#1 controller
SATA#2 Configuration	Disabled Enhanced	Controls the mode for the 2nd SATA controller in ICH-9
Hard Disk Write Protect	Disabled Enabled	Disables/enables device write protection. It will be effective only if device is accessed through BIOS functions.
IDE Detect Time Out (Sec.)	[0-35] 1	Selects the time out value for the detection of ATA/ATAPI devices
ATA<PI> 80Pin Cable Detection	Host & Device Host Device	Selects the mechanism for detecting 80Pin ATA<PI> cables.

## IDE Device Submenu

BIOS SETUP UTILITY		
Advanced		
<b>Secondary IDE Master</b>		Select the type of device connected to the system.
Device :Hard Disk Vendor :WDC WD1600AAJS-56WAA0 Size :160.0GB LBA Mode :Supported Block Mode:16Sectors PIO Mode :4 Async DMA :MultiWord DMA-2 Ultra DMA :Ultra DMA-6 S.M.A.R.T. :Supported		
Type	[Auto]	← Select Screen
LBA/Large Mode	[Auto]	↑↓ Select Item
Block <Multi-Sector Transfer>	[Auto]	+− Change Option
PIO Mode	[Auto]	F1 General Help
DMA Mode	[Auto]	F10 Save and Exit
S.M.A.R.T.	[Auto]	ESC Exit
32Bit Data Transfer	[Disabled]	
v02.61 <C>Copyright 1985-2006, American Megatrends, Inc.		

Feature	Option	Description
Type	Not Installed <b>Auto</b> CD/DVD ARMD	Selects the type of the IDE Devices connected to the system
LBA/Large Mode	Disabled <b>Auto</b>	Disables the LBA mode or enables it, when a device supports it
Block (Multi-Sector Transfer)	Disabled <b>Auto</b>	Disabled: The data transfer from and to the device occurs one sector at a time Auto: The data transfer from and to the device occurs multiple sectors at a time if the device supports it
PIO Mode	<b>Auto</b> 0 1 2 3 4	(Auto) Configures the PIO Mode
DMA Mode	<b>Auto</b> SWDMAn MWDMA UDMA	SWDMA: Single Word DMA MWDMA: Multi Word DMA UDMA: Ultra DMA
S.M.A.R.T.	<b>Auto</b> Enabled Disabled	Disables, Enables or automatically enables the S.M.A.R.T feature (Self-Monitoring, Analysis and Reporting Technology)
32Bit Data Transfer	<b>Enabled</b> Disabled	Disables and Enables the 32Bit Data Transfer Mode

## AHCI Configuration

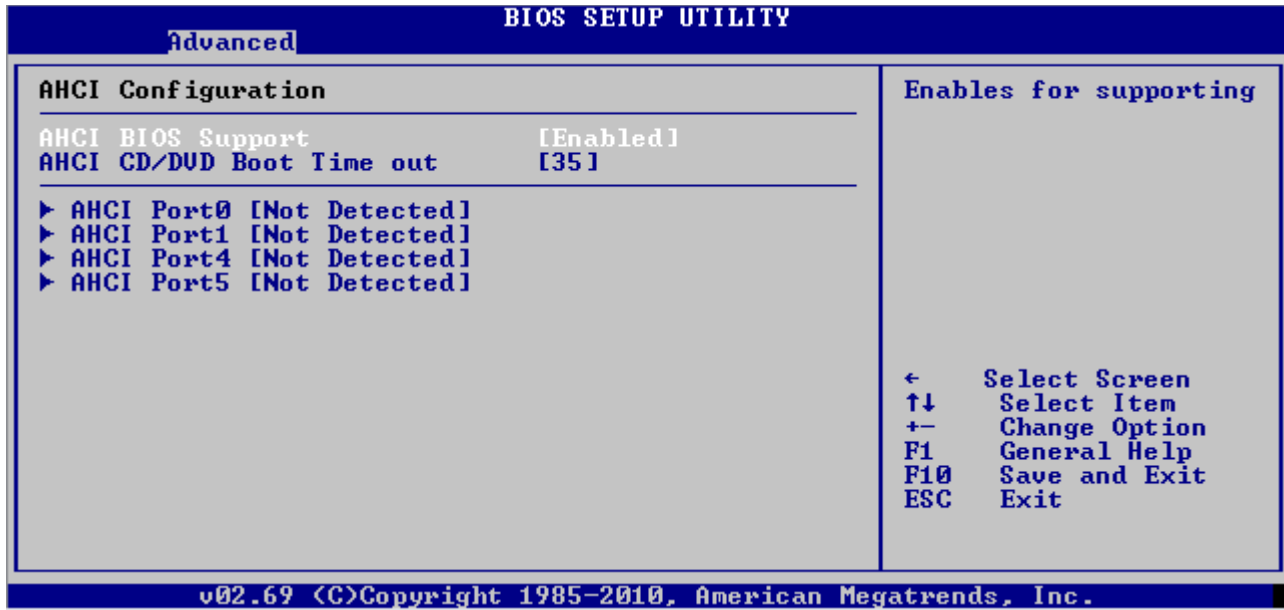

Feature	Option	Description
AHCI BIOS Support	Enabled Disabled	Enables / Disables the AHCI Support in BIOS
AHCI CD/DVD Boot Time out	0 5 10 ... 35	Selects the boot time out for AHCI CD/DVD devices



## AHCI PortN Submenu

Advanced		BIOS SETUP UTILITY
<b>AHCI Port0</b>		Select the type of device connected to the system.
Device	:Not Detected	
SATA Port0	[Auto]	← Select Screen ↑↓ Select Item +- Change Option F1 General Help F10 Save and Exit ESC Exit
S.M.A.R.T.	[Enabled]	
v02.61 (C)Copyright 1985-2006, American Megatrends, Inc.		

Feature	Option	Description
SATA Port N	<b>Auto</b> Not installed	Enables / Disables this AHCI Port
S.M.A.R.T.	Disabled <b>Enabled</b>	Enables and disables the SMART functionality.

## SuperIO Configuration

BIOS SETUP UTILITY		
Advanced		
<b>Configure Win627 Super IO Devices</b>		Allows BIOS to Enable or Disable Floppy Controller.
Floppy Controller	[Disabled]	
Floppy Drive Swap	[Disabled]	
▶ Floppy Configuration		
Serial Port1 Address	[3F8/IRQ4]	
Serial Port2 Address	[Disabled]	
Parallel Port Address	[Disabled]	
Keyboard PowerOn	[Disabled]	
Specific Key PowerOn		
Mouse PowerOn	[Disabled]	
		← Select Screen ↑↓ Select Item +- Change Option F1 General Help F10 Save and Exit ESC Exit
v02.69 <C>Copyright 1985-2010, American Megatrends, Inc.		

Feature	Option	Description
Floppy Controller	Disabled Enabled	Enables / Disables the floppy controller in BIOS
Floppy Drive Swap	Disabled Enabled	If enabled floppy drive A and B are swapped.
Serial Port1 Address	Disabled 3F8/IRQ4 2F8/IRQ3 3E8/IRQ4 2E8/IRQ3	Selects the Address of COM Port 1
Serial Port2 Address	Disabled 3F8/IRQ4 2F8/IRQ3 3E8/IRQ4 2E8/IRQ3	Selects the Address of COM Port 2
Parallel Port Address	Disabled 378 278 3BC	Selects the Address of the LPT Port
Parallel Port Mode	SPP Bi-Directional ECP EPP+SPP ECP+SPP	Allows BIOS to Select Parallel Port Mode. (Only visible when Parallel Port enabled.)
Parallel Port IRQ	IRQ5 IRQ7	Allows BIOS to Select Parallel Port IRQ. (Only visible when Parallel Port enabled.)
Keyboard Power On	Disabled Specific Key Any Key	Selects the Mode for PS/2 Keyboard Power On
Specific Key Power On	[Enter Key]	Only available when Specific Key is selected then "Enter New Password" Pop Up appears
Mouse Power On	Disables Left Button Right Button	Selects teh Mode for PS/2 Mouse Power On

## Floppy Configuration Submenu

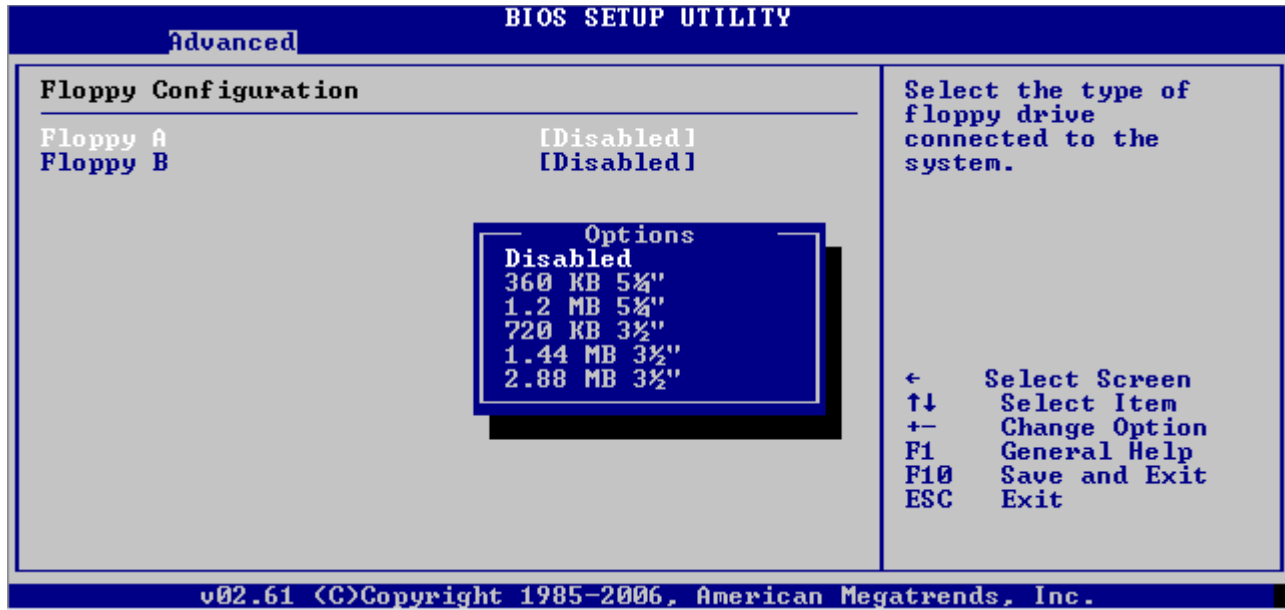

Feature	Option	Description
Floppy A	<b>Disabled</b> 360 KB 5 1/4" 1.2 MB 5 1/4" 720 KB 3 1/2" 1.44 MB 3 1/2" 2.88 MB 3 1/2"	Selects the Floppy Drive A
Floppy B	<b>Disabled</b> 360 KB 5 1/4" 1.2 MB 5 1/4" 720 KB 3 1/2" 1.44 MB 3 1/2" 2.88 MB 3 1/2"	Selects the Floppy Drive B

## ACPI Configuration

**BIOS SETUP UTILITY**

**Advanced**

<b>ACPI Settings</b>	Enable RSDP pointers to 64-bit Fixed System Description Tables. Different ACPI version has some addition.
ACPI Version Features [ACPI v4.0]	← Select Screen ↑↓ Select Item +- Change Option F1 General Help F10 Save and Exit ESC Exit
ACPI APIC support [Enabled]	
Repost Video on S3 Resume [No]	
Headless mode [Disabled]	
USB Device Wakeup From S3/S4 [Disabled]	
High Performance Event Timer [Enabled]	
HPET Memory Address [FED00000h]	
▶ ACPI Cooling Options -	

v02.69 (C)Copyright 1985-2010, American Megatrends, Inc.

Feature	Option	Description
ACPI Version	ACPI v.4.0 ACPI v.3.0 ACPI v.2.0 ACPI v.1.0	Selects the ACPI version
ACPI APIC support	Enabled Disabled	Include ACPI APIC table pointer to RSDT pointer list.
Repost Video on S3 Resume	No Yes	If yes, Videobios is reinitialized after S3 Resume
Headless Mode	Disabled Enabled	Enables / Disables headless mode through ACPI
USB Device Wakeup From S3/S4	Disabled Enabled	Enables / Disables the possibility to wake up via USB from S3 and S4
High Performance Event Timer	Disabled Enabled	Enables / Disables the High Performance Event Timer
HPET Memory Address	FED00000h FED01000h FED02000h FED03000h	Selects the Address of the High Performance Event Timer

## ACPI Cooling Options

BIOS SETUP UTILITY		
Advanced		
<b>ACPI Cooling Options</b>		This value controls the temperature of the ACPI Passive Trip Point - the point in which the OS will begin throttling the CPU.  ← Select Screen ↑↓ Select Item +- Change Option F1 General Help F10 Save and Exit ESC Exit
Passive Trip Point:	[Disabled]	
Critical Trip Point:	[ 110°C]	
v02.61 <C>Copyright 1985-2006, American Megatrends, Inc.		

Feature	Option	Description
Passive Trip Point	<b>Disabled</b> 40°C 45°C 50°C ... 110°C	This value controls the temperature of the ACPI Passive Trip Point - the point in which the OS will begin throttling the CPU.
Passive TC1 value	<b>1</b> 2 3 ... 16	This value sets the TC1 value for the ACPI Passive Cooling Formula. (Only visible when Passive Trip Point is enabled.)
Passive TC2 value	1 2 ... <b>5</b> ... 16	This value sets the TC2 value for the ACPI Passive Cooling Formula. (Only visible when Passive Trip Point is enabled.)
Passive TSP value	2 4 ... <b>10</b> ... 30	This item sets the TSP value for the ACPI Passive Cooling Formula. It represents in tenths of a second how often the OS will read the temperature when Passive Cooling is Enabled.
Critical Trip Point	Disabled 40°C 45°C 50°C ... <b>110°C</b>	This value controls the temperature of the ACPI Critical Trip Point - the point in which the OS will shut off the system.

## Passive Cooling

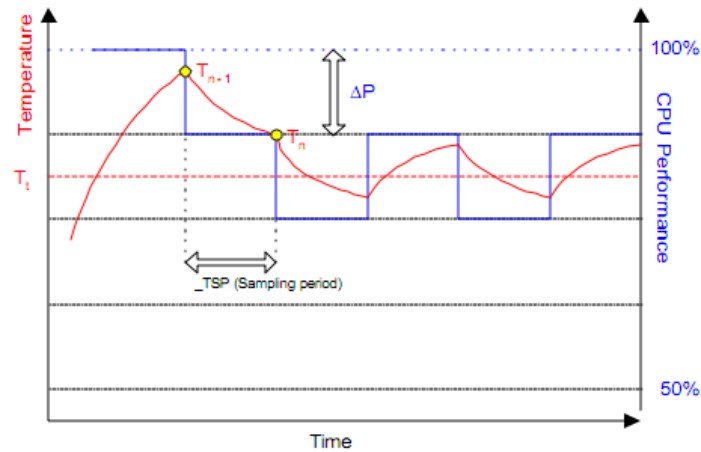

The ACPI OS assesses the optimum CPU performance change necessary to lower the temperature using the following equation

$$P[\%] = TC1(T_n - T_{n-1}) + TC2(T_n - T_t)$$

P is the performance delta,  $T_t$  is the target temperature = passive cooling trip point. The two coefficients TC1 and TC2 and the sampling period TSP are hardware dependent constants the end user must supply. It's up to the end user to set the cooling preference of the system by setting the appropriate trip points in the BIOS setup.



See chapter 12 of the ACPI specification ([www.acpi.info](http://www.acpi.info)) for more details

## PCIExpress Configuration

BIOS SETUP UTILITY		
Advanced		
<b>PCI Express Configuration</b>		Enables/Disables Pci Express Device Relaxed Ordering.
Relaxed Ordering	[Auto]	
Maximum Payload Size	[Auto]	
Extended Tag Field	[Auto]	
No Snoop	[Auto]	
Maximum Read Request Size	[Auto]	
Active State Power Management	[Disabled]	
Extended Synch	[Auto]	
PCIE Port 0		[Auto]
PCIE Port 1		[Auto]
PCIE Port 2		[Auto]
PCIE Port 3		[Auto]
PCIE Port 4		[Auto]
PCIE High Priority Port		[Disabled]
PCIE Port 0 IOxAPIC Enable	[Disabled]	
PCIE Port 1 IOxAPIC Enable	[Disabled]	
PCIE Port 2 IOxAPIC Enable	[Disabled]	
PCIE Port 3 IOxAPIC Enable	[Disabled]	
PCIE Port 4 IOxAPIC Enable	[Disabled]	
PCIE Port 5 IOxAPIC Enable	[Disabled]	
		← Select Screen
		↑↓ Select Item
		+− Change Option
		F1 General Help
		F10 Save and Exit
		ESC Exit
v02.69 (C)Copyright 1985-2010, American Megatrends, Inc.		

Feature	Option	Description
Relaxed Ordering	<b>Auto</b> Disables Enabled	Enables/Disables PCI Express Device Relaxed Ordering.
Maximum Payload Size	<b>Auto</b> 128 Bytes ... 4096 Bytes	Set Maximum Payload of PCI Express Device or allow System BIOS to select the value.
Extended Tag Field	<b>Auto</b> Disables Enabled	If Enabled, allows Device to use 8-bit TAG field as a requester.
No Snoop	<b>Auto</b> Disables Enabled	Enables/Disables PCI Express Device No Snoop option.
Maximum Read Request Size	<b>Auto</b> 128 Bytes ... 4096 Bytes	Set Maximum Read Request Size of PCI Express Device or allow System BIOS to select the value.
Active State Power Management	<b>Disabled</b> Enabled	Enables/Disables PCI Express L0 and L1 link power states.
Extended Synch	<b>Auto</b> Disables Enabled	If Enabled, allows generation of Extended Synchronisation patterns.
PCIE Port N	<b>Auto</b> Enabled Disabled	Enables/Disables or autoconfigures the PCIE Port N
PCIE High Priority Port	<b>Disabled</b> Port 0 Port 1 Port 2 ... Port 5	Select the PCIE Port that gets higher priority than the others.
PCIE Port N IOxAPIC Enable	<b>Disabled</b> Enabled	Enables/Disables the APIC Support for the PCIE Port N

## USB Configuration

BIOS SETUP UTILITY		
Advanced		
USB reset delay	[Disabled]	Enable extra delay after reset during USB initialization. This will give slow devices more time to get ready after they have been reset.
<b>USB Configuration</b>		
Module Version - 3.0.0-14.4		
USB Devices Enabled : 1 Keyboard, 1 Mouse		
Legacy USB Support	[Enabled]	← Select Screen ↑↓ Select Item +- Change Option F1 General Help F10 Save and Exit ESC Exit
Port 64/60 Emulation	[Enabled]	
USB 2.0 Controller Mode	[HiSpeed]	
BIOS EHCI Hand-Off	[Enabled]	
USB Beep Message	[Enabled]	
v02.69 (C)Copyright 1985-2010, American Megatrends, Inc.		

Feature	Option	Description
USB reset delay	Disabled Enabled	Enable extra delay after reset during USB initialization. This will give slow devices more time to get ready after they have been reset.
Legacy USB Support	Auto Disabled Enabled	Enables support for legacy USB. Auto option disables legacy support if no USB devices are connected.
Port 64/60 Emulation	Disabled Enabled	Enables I/O port 60h/64h emulation support. This should be enabled for the complete USB keyboard legacy support for non-USB aware OSes.
USB 2.0 Controller Mode	FullSpeed HiSpeed	Configures the USB 2.0 controller in HiSpeed (480Mbps) or FullSpeed (12Mbps)
BIOS EHCI Hand-Off	Disabled Enabled	This is a workaround for an OS without EHCI hand-off support. The EHCI ownership change should claim by the EHCI driver
USB Beep Message	Disabled Enabled	Enables the beep during USB device enumeration



## USB Mass Storage Device Configuration

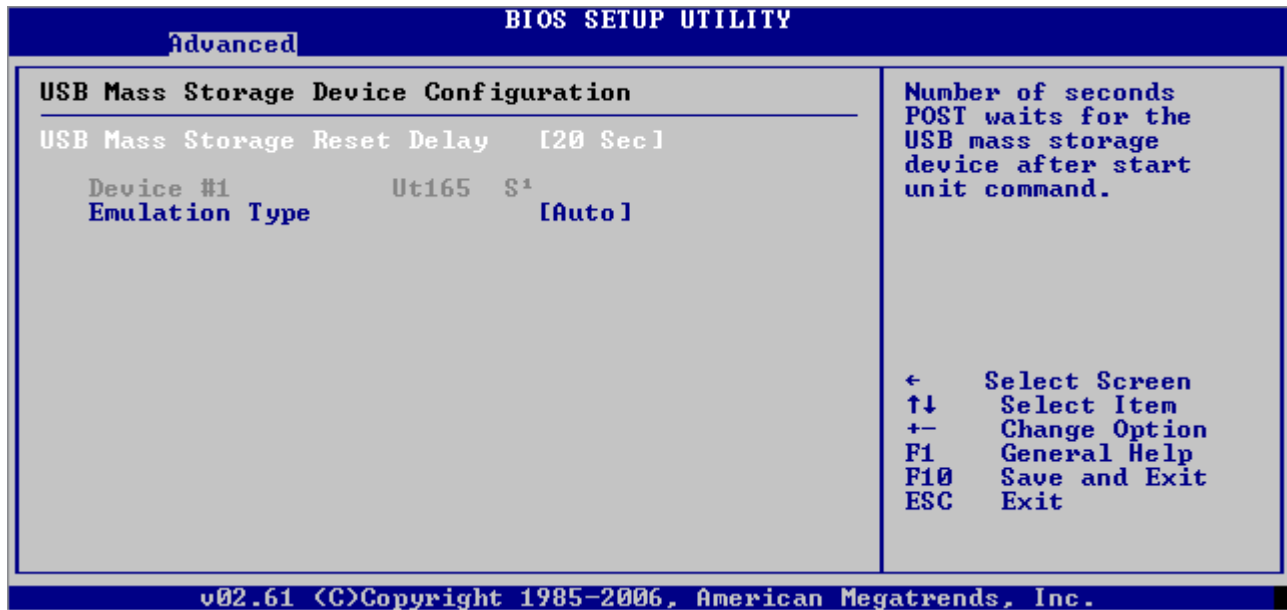

Feature	Option	Description
USB Mass Storage Reset Delay	10 Sec <b>20 Sec</b> 30 Sec 40 Sec	Number of seconds POST waits for the USB mass storage device after start unit command.
Emulation Type	<b>Auto</b> Floppy Forced FDD Hard Disk CDROM	If Auto USB devices with less than 20MB will be emulated as floppy and remaining as hard drive. Forced FDD option can be used to force a HDD formatted drive to boot as FDD (Ex. ZIP drive).

## Hardware Health



## Module Hardware Health Configuration

Advanced		BIOS SETUP UTILITY	
<b>Module Hardware Health Configuration</b>		<b>Enables Hardware Health Monitoring Device.</b>	
H/W Health Function	[Enabled]	← Select Screen ↑↓ Select Item +- Change Option F1 General Help F10 Save and Exit ESC Exit	
PWM 1 Mode Setting	[Fan Manually Mode]		
PWM 1 Ramp Rate	[Time Slot 1]		
PWM 1 Control Duty Cycle	[200]		
Pulses/Rev	[2]		
Fan Voltage	[5V]		
CPU Temperature : 43°C/109°F			
Internal Temperature : 45°C/113°F			
Northbridge Temperature : 45°C/113°F			
Fan1 Speed : N/A			
backup battery supply voltage : 2.61 V			
3.3 V supply voltage : 3.28 V			
v02.69 <C>Copyright 1985-2010, American Megatrends, Inc.			

Feature	Option	Description
H/W Health Function	Disabled <b>Enabled</b>	Enables Hardware Health Monitoring Device.
PWM 1 Mode Setting	Auto Fan Mode Fan Always On Full Fan Disable Mode <b>Fan Manually Mode</b>	PWM Configuration Mode Setting
PWM 1 Ramp Rate	<b>Time Slot 1</b> Time Slot 2 Time Slot 3 Time Slot 4 Time Slot 8 Time Slot 12 Time Slot 24 Time Slot 48	
PWM 1 Control Duty Cycle	[0...255] <b>200</b>	Controls the length of a PWM duty cycle.
Pulses/Rev	[1...4] <b>2</b>	
Fan Voltage	12V <b>5V</b>	Selects the fan voltage. (only possible with premium fan hardware solution)

## Baseboard Hardware Health

**BIOS SETUP UTILITY**

**Advanced**

---

**BaseBoard Hardware Health Configuration**

H/W Health Function [Enabled]

---

**Hardware Health Event Monitoring**

Temperature Sensor #1 : -42°C/107°F  
 Temperature Sensor #2 : -43°C/109°F  
 Temperature Sensor #3 : -43°C/109°F

Fan Speed Selector [4]  
 Fan Ticks per Rev [2]  
 Fan1 Speed : 3668 RPM  
 Fan Speed Selector [4]  
 Fan Ticks per Rev [2]  
 Fan2 Speed :No Function  
 Fan Speed Selector [4]  
 Fan Ticks per Rev [2]  
 Fan3 Speed :No Function

UcoreA : 1.838 V  
 UcoreB : 3.387 V  
 +3.3Vin : 3.467 V  
 +5U regular : 5.160 V  
 +12Vin : 12.160 V  
 -12Vin : -12.528 V  
 -5Vin : -7.714 V  
 +5U standby : 5.164 V  
 backup battery supply voltage : 3.258 V

← Select Screen  
 ↑↓ Select Item  
 +- Change Option  
 F1 General Help  
 F10 Save and Exit  
 ESC Exit

← Select Screen  
 ↑↓ Select Item  
 +- Change Option  
 F1 General Help  
 F10 Save and Exit  
 ESC Exit

---

v02.69 (C)Copyright 1985-2010, American Megatrends, Inc.

Feature	Option	Description
H/W Health Function	Disabled Enabled	Enables Hardware Health Monitoring Device.
Fan Speed Selector	1 2 4 ... 128	Select the Fan1/2/3 Speed Divisor according to nominal revolutions per minute of the used fan
Fan Ticks per Rev	1 2 4 8	Number of Ticks per Revolution

## Miscellaneous Settings

BIOS SETUP UTILITY	
Advanced	
<b>Miscellaneous Settings</b> ▶ Event Log Configuration Post User Delay [1 Sec] Restore on AC Power Loss [Power On] Power Up Delay [Disabled] On Reset [Chipset Reset] Standby Voltage [Auto] Keyboard Crisis Recovery [Enabled] S5 Eco [Disabled] Spread Spectrum [Disabled]  ▶ MARS Interface Configuration ▶ Watchdog ▶ I2C Buses ▶ Remote Access Configuration ▶ Ethernet Configuration	<b>Mark as read, Clear or View Event Log statistics.</b>          ← Select Screen ↑↓ Select Item Enter Go to Sub Screen F1 General Help F10 Save and Exit ESC Exit
v02.69 (C)Copyright 1985-2010, American Megatrends, Inc.	

Feature	Option	Description
Post User Delay	None 1 Sec 2 Sec ... 10 Min	Delay during POST
Restore on AC Power Loss	Power Off Power On	Controls the behavior after Power Loss in ATX mode
Power Up Delay	Disabled 4 to 5 seconds 3 to 4 seconds 2 to 3 seconds 1 to 2 seconds	Delay after power up, when in an G3 cycle
On Reset	Chipset Reset Power Cycle	Controls the behavior in reset case.
Standby Voltage	5V Standby Auto	Select which voltage is used for standby power. If using a standard ATX power supply, select 5V.
Keyboard Crisis Recovery	Disabled Enabled	Enables/Disables Keyboard Crisis Recovery function by USB keyboard
S5 Eco	Disabled Enabled	Enables/Disables S5 Eco Mode to reduce supply current in soft off (S5). See manual for usage of S5 Eco.
Spread Spectrum	Disabled PCI CPU Both	Enable/Disable Spread Spectrum for the selected clocks

## Event Log Configuration

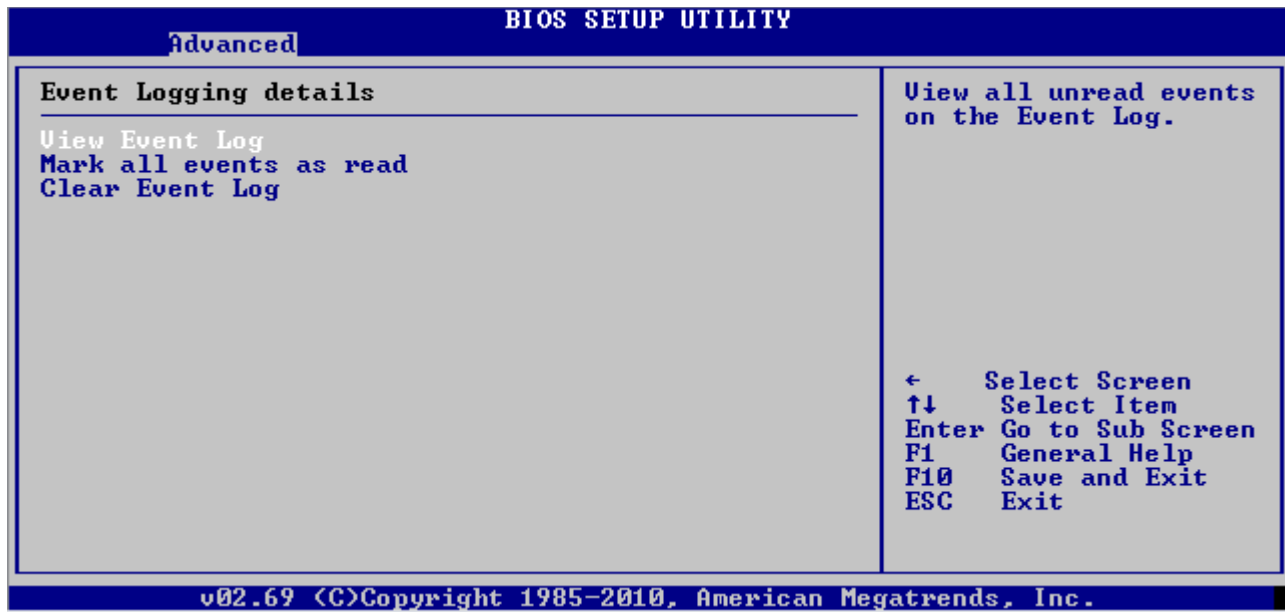

Feature	Option	Description
View Event Log		View All Unread Events in the Event Log
Mark all events as read		Mark All Unread Events as read
Clear Event Log		Discard All Unread Events in the Event Log

## MARS Interface Configuration

Advanced		MARS Feature	
<b>MARS Interface Configuration</b>		<b>MARS (Mobile Application platform for Rechargeable Systems) Configuration</b>	
MARS	[Disabled]		
System Type	: Disabled		
Power Source	: AC		
<div style="border: 1px solid black; padding: 5px; display: inline-block;">           Options            Disabled            Auto            SMB Charger            SMB Manager         </div>			
		← Select Screen ↑↓ Select Item +- Change Option F1 General Help F10 Save and Exit ESC Exit	
v02.61 (C)Copyright 1985-2006, American Megatrends, Inc.			

Feature	Option	Description
MARS	Disabled Auto SMB Charger SMB Manager	Enables the MARS function

## Watchdog

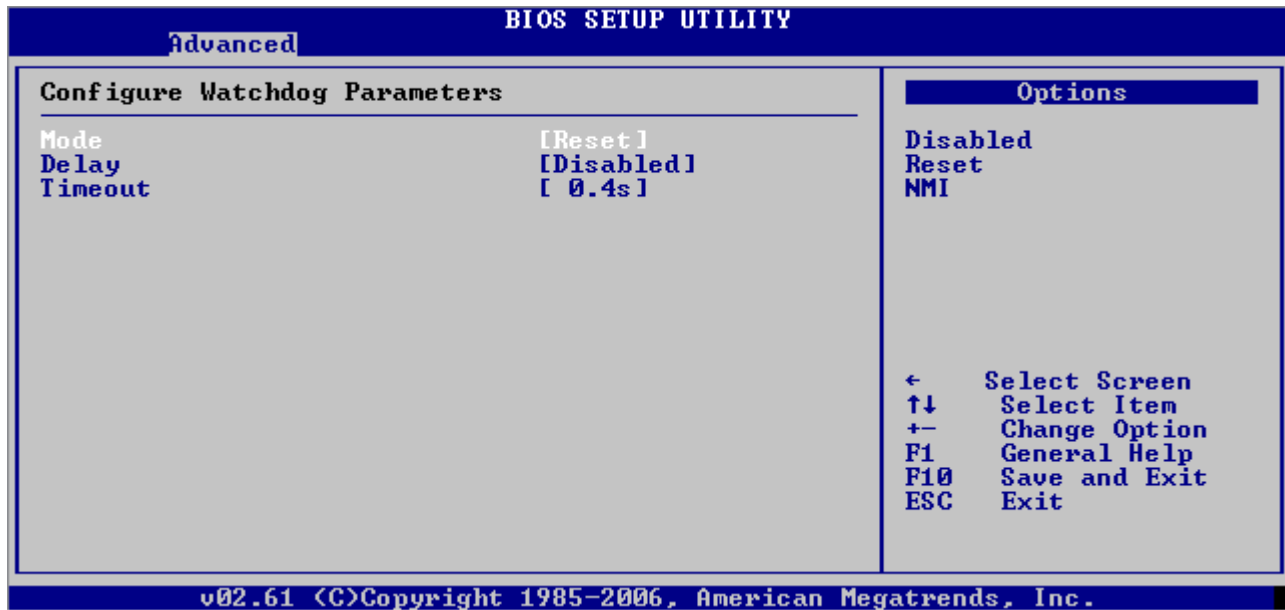

Feature	Option	Description
Mode	Reset <b>Disabled</b> NMI	Selects the mode of the watchdog
Delay	<b>Disabled</b> 1s 5s 10s 30s 1:00m 5:00m 10:00m 30:00m	Controls the delay after the watchdog is initialized
Timeout	<b>0.4s</b> 1s 5s 10s 30s 1:00m 5:00m 10:00m	Set the timeout for Watchdog



## I2C Busses



Feature	Option	Description
External I2C Bus Speed	800Khz <b>400Khz</b> 200Khz ... 3Khz	Controls the Bus Speed of the external I2C bus

## Remote Access Configuration

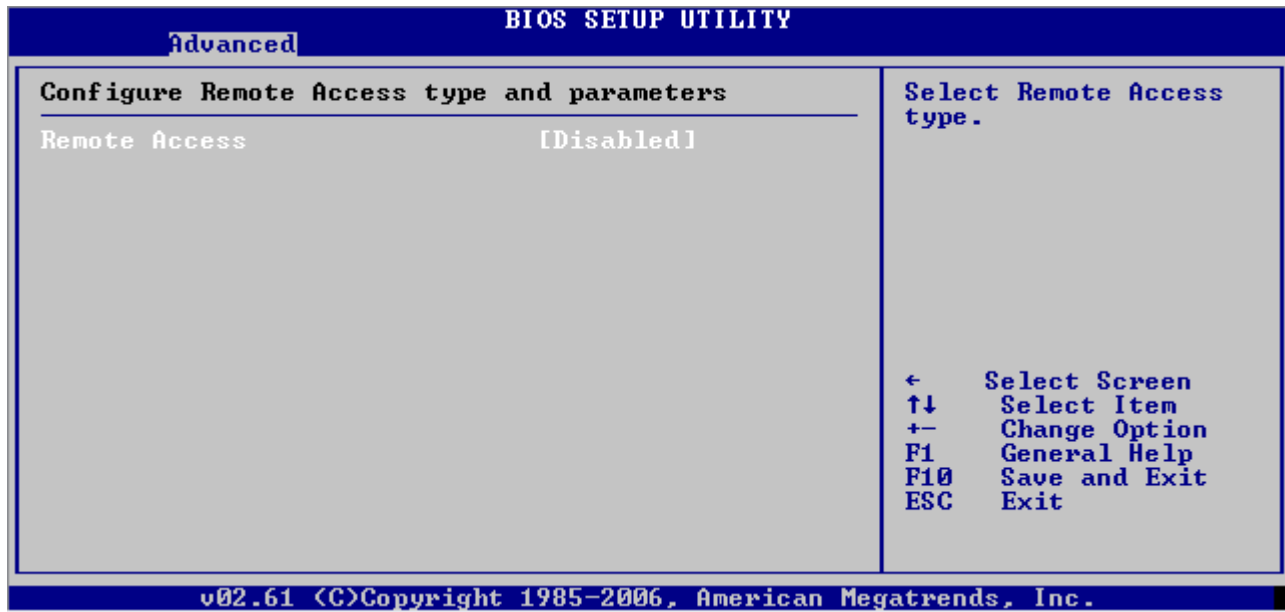

Feature	Option	Description
Remote Access	Enabled Disabled	Enables Remote Access via AMI Console Redirection

## Ethernet Configuration

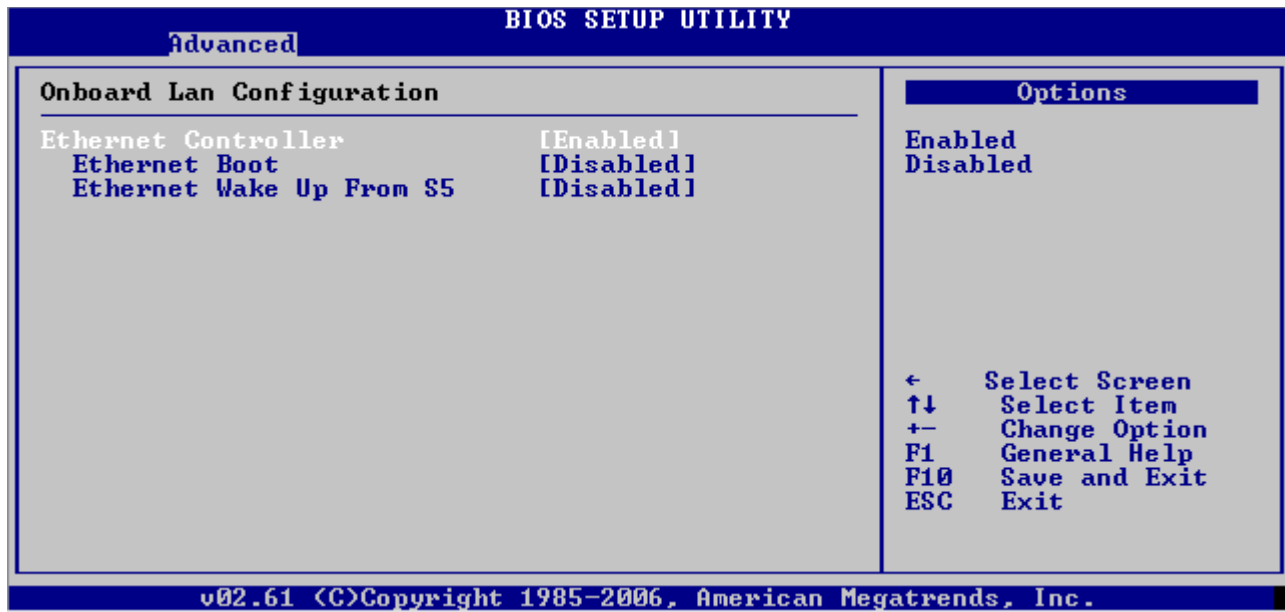

Feature	Option	Description
GbE LAN	Disabled Enabled	Disables / Enables the onboard Ethernet interface
GbE LAN Boot	Disabled Enabled	Disables / Enables the PXE Boot ROM
GbE Wake Up From S5	Disabled Enabled	Disables / Enables the WOL function from S5 ACPI state

## Features

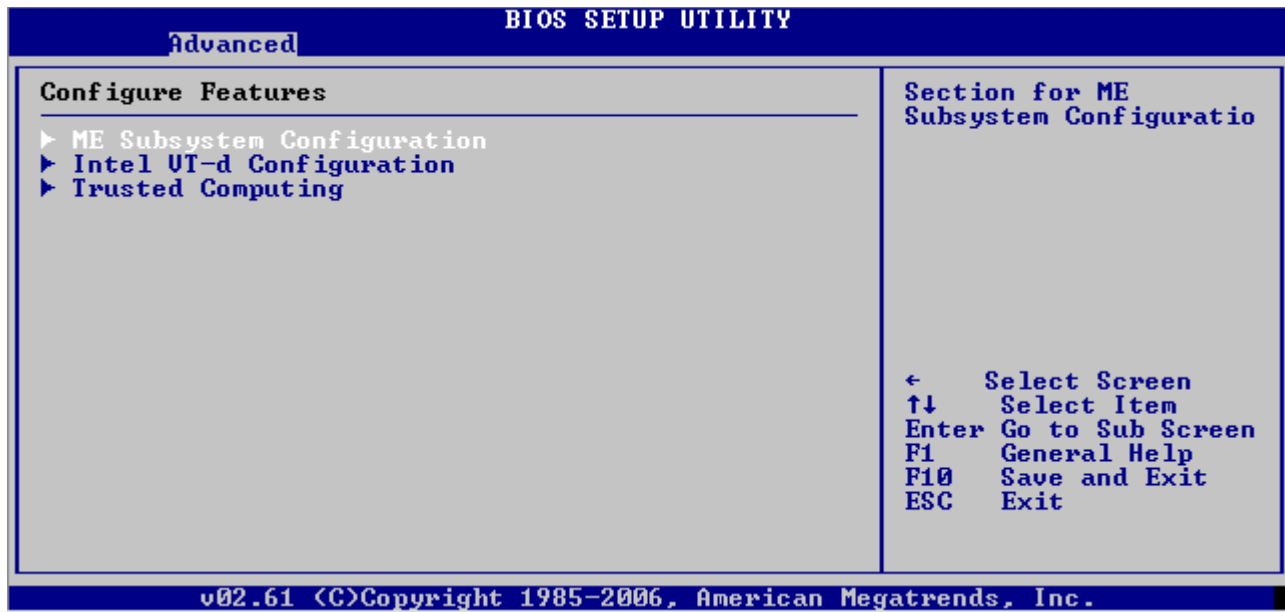

## ME Subsystem Configuration

**BIOS SETUP UTILITY**

**Advanced**

<b>ME Subsystem Configuration</b>	<b>Options</b>
BootBlock HECI Message      [Enabled] HECI Message                    [Enabled] End Of Post S5 HECI Message   [Enabled]	Disabled Enabled
<b>ME HECI Configuration</b> ME-HECI                            [Enabled]	←    Select Screen ↑↓   Select Item +-   Change Option F1   General Help F10  Save and Exit ESC  Exit

v02.61 <C>Copyright 1985-2006, American Megatrends, Inc.

Feature	Option	Description
BootBlock HECI Message	Enabled Disabled	Selects the mode of the watchdog
HECI Message	Enabled Disabled	Enables / Disables the HECI Message
End of Post S5 HECI Message	Enabled Disabled	
ME-HECI	Enabled Disabled	

## Intel VT-d Configuration

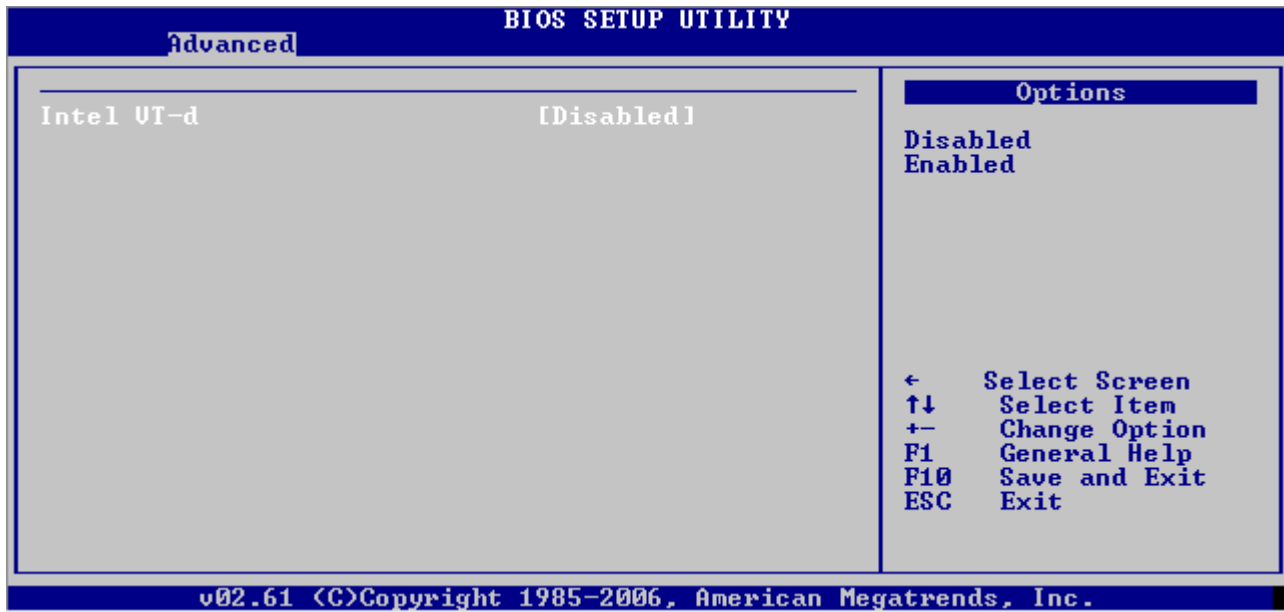

Feature	Option	Description
Intel VT-d	Enabled Disabled	Enables / Disables Intel Virtualisation Technology support

## Trusted Computing

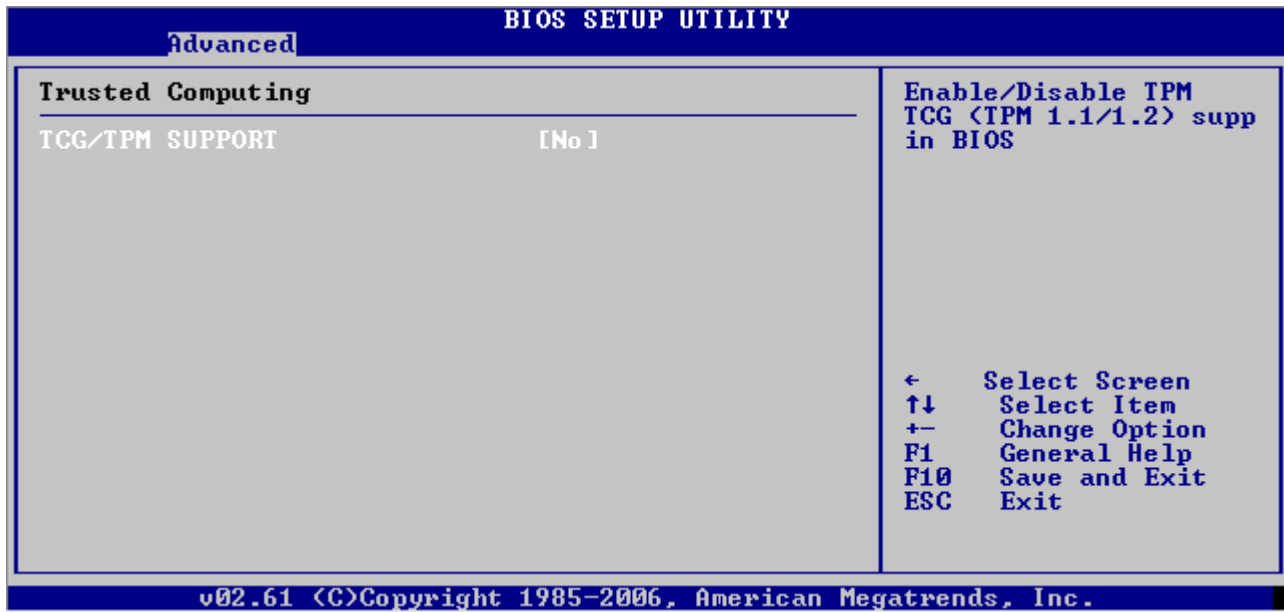

Feature	Option	Description
TCG/TPM Support	Yes No	Enables / Disables Trusted Computing and Trusted Platform Module

## 8.4.4 PCIPnP Menu

BIOS SETUP UTILITY		
Main	Advanced	PCIPnP
Boot	Security	Chipset
Exit		
<b>Advanced PCI/PnP Settings</b>		<b>Clear NURAM during System Boot.</b>
<b>WARNING: Setting wrong values in below sections may cause system to malfunction.</b>		
Clear NURAM	[No]	
Plug & Play O/S	[No]	
PCI Latency Timer	[64]	
Allocate IRQ to PCI UGA	[Yes]	
Palette Snooping	[Disabled]	
PCI IDE BusMaster	[Enabled]	
OffBoard PCI/ISA IDE Card	[Auto]	
IRQ3	[Available]	
IRQ4	[Available]	
IRQ5	[Available]	
IRQ7	[Available]	
IRQ9	[Available]	
IRQ10	[Available]	
IRQ11	[Available]	
IRQ14	[Available]	
IRQ15	[Available]	
DMA Channel 0	[Available]	
DMA Channel 1	[Available]	
DMA Channel 3	[Available]	
DMA Channel 5	[Available]	
DMA Channel 6	[Available]	
DMA Channel 7	[Available]	
		← Select Screen
		↑↓ Select Item
		+− Change Option
		F1 General Help
		F10 Save and Exit
		ESC Exit
v02.61 (C)Copyright 1985-2006, American Megatrends, Inc.		

Feature	Option	Description
Clear NVRAM	No Yes	Clear NVRAM once during next system boot.
Plug & Play O/S	No Yes	No: all devices are initialized by BIOS Yes: OS has to initialize some devices
PCI Latency Timer	32 64 ... 248	Value in units of PCI clocks for PCI device latency register
Allocate IRQ to PCI VGA	Yes No	Decided if PCI VGA card does get an IRQ assigned if requested
Palette Snooping	Disabled Enabled	Disables and enables Palette Snooping
PCI IDE BusMaster	Disabled Enabled	Disables and enables PCI IDE Busmaster
OffBoard PCI/ISA IDE Card	Auto PCISlot 1 PCISlot 2 ... PCISlot 6	Some IDE Cards needs this , with set to Auto it works with most cards
IRQ3 ... IRQ15	Available Reserved	Available: IRQ useable by PCI/PnP devices Reserved: IRQ is reserved for ISA devices
DMA Channel 0 ... DMA Channel 7	Available Reserved	Available: DMA useable by PCI/PnP devices Reserved: IRQ is reserved for ISA devices



## 8.4.5 Boot

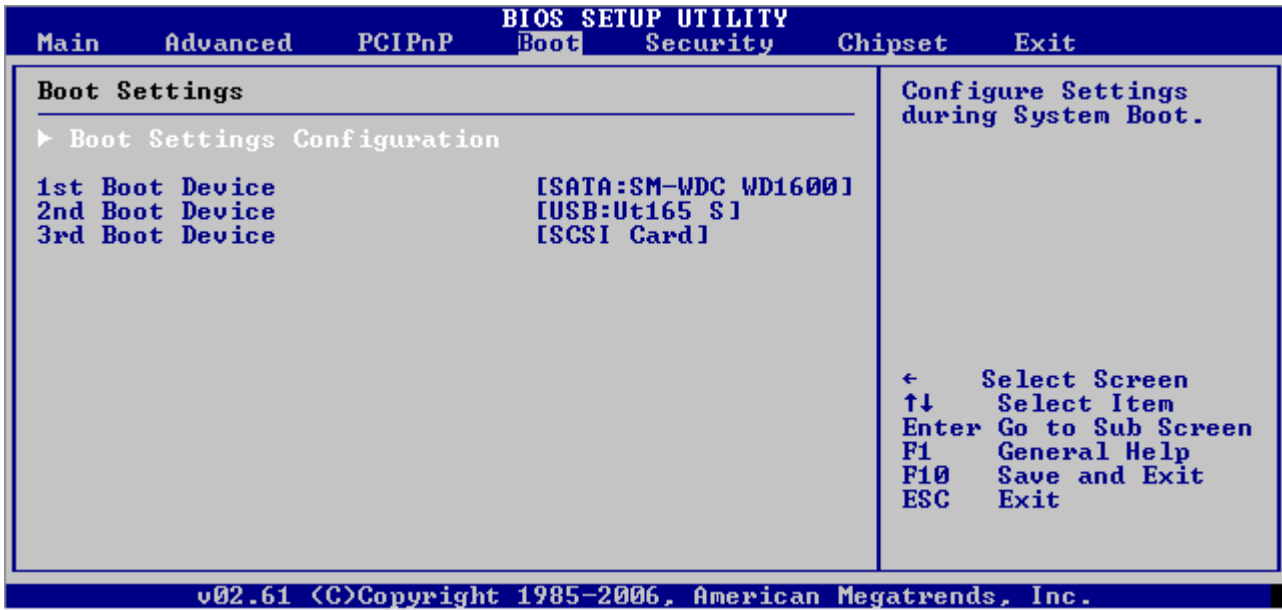

## Boot Setting Configuration

BIOS SETUP UTILITY		
Boot		
<b>Boot Settings Configuration</b>		Allows BIOS to skip certain tests while booting. This will decrease the time needed to boot the system.
Quick Boot	[Enabled]	
Display Mode	[Graphics]	← Select Screen ↑↓ Select Item +- Change Option F1 General Help F10 Save and Exit ESC Exit
Quiet Boot	[Disabled]	
AddOn ROM Display Mode	[Force BIOS]	
Bootup Num-Lock	[On]	
PS/2 Mouse Support	[Auto]	
Wait For 'F1' If Error	[Disabled]	
Hit 'DEL' Message Display	[Enabled]	
Boot USB HDD First	[Disabled]	
Interrupt 19 Capture	[Disabled]	
v02.69 <C>Copyright 1985-2010, American Megatrends, Inc.		

Feature	Option	Description
Quick Boot	Enabled Disabled	Disables or enables the quick boot feature
Display Mode	Graphics Text	Select Display Mode
Quiet Boot	Disabled Enabled	Disabled: Shows normal POST messages Enabled: Shows OEM Logo during boot up
AddOn ROM Display Mode	Force BIOS Keep Current	Set Display Mode for Option ROM
Bootup Num-Lock	On Off	Select Power-On state for Num-Lock
PS/2 Mouse Support	Auto Disabled Enabled	Disables and enables or auto selects PS/2 Mouse Support
Wait For 'F1' If Error	Disabled Enabled	Wait for F1 key to be pressed, if error
Hit 'DEL' Message Display	Enabled Disabled	Displays: "Hit 'DEL' to run setup" during POST, if enabled
Boot USB HDD first	Disabled Enabled	If enabled, boots new attached USB HDD always first.
Interrupt 19 Capture	Disabled Enabled	Allows option ROMs to trap INT19h if enabled

## 8.4.6 Security

BIOS SETUP UTILITY						
Main	Advanced	PCIPnP	Boot	Security	Chipset	Exit
<b>Security Settings</b> <hr/> Supervisor Password :Not Installed User Password :Not Installed  Change Supervisor Password Change User Password  Boot Sector Virus Protection [Disabled]  <b>Hard Disk Security</b> <hr/> Secondary Master HDD Password Status :Disabled  Secondary Master HDD User Password				Install or Change the password.       ← Select Screen ↑↓ Select Item Enter Change F1 General Help F10 Save and Exit ESC Exit		
v02.61 <C>Copyright 1985-2006, American Megatrends, Inc.						

Feature	Option	Description
Change Supervisor Password	Type in	
Change User Password	Type in	
Boot Sector Virus Protection	Disabled Enabled	Enables or disables boot sector virus protection.

## 8.4.7 Chipset

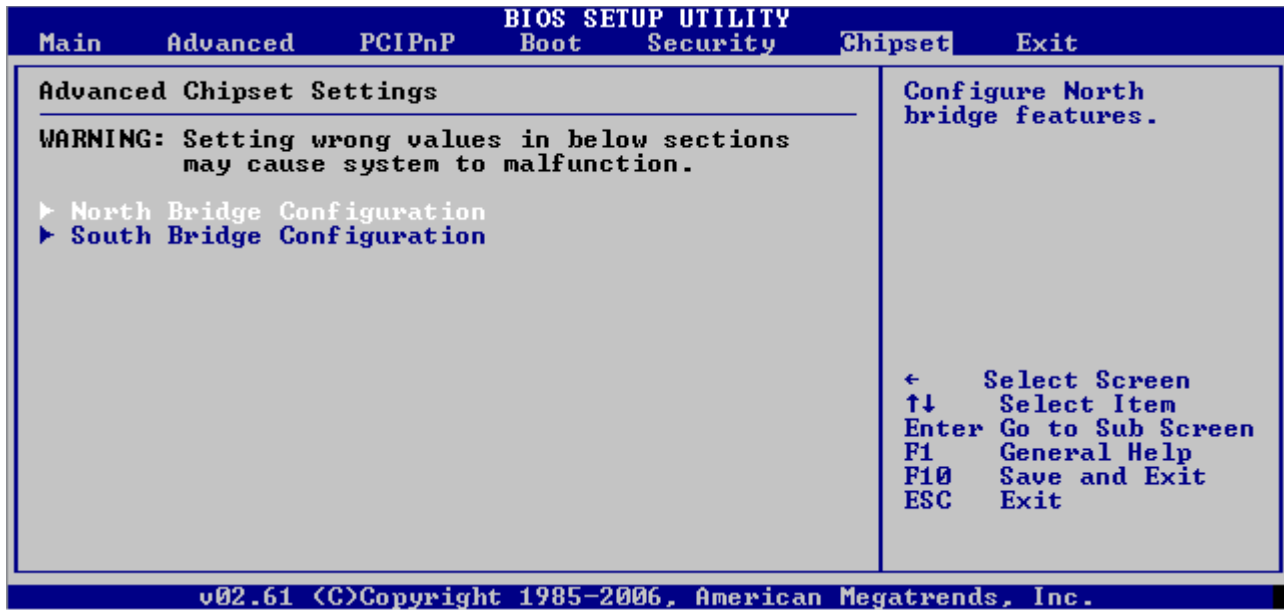

## North Bridge Configuration

BIOS SETUP UTILITY		Chipset
<b>North Bridge Chipset Configuration</b>		<b>Options</b>
DRAM Frequency	[Auto]	Auto
Configure DRAM Timing by SPD	[Enabled]	800 MHz
		1067 MHz
<b>Thermal Memory Reference Code&lt;TMRC&gt;</b>		
TMRC Mode	[Enabled]	
TM Lock	[Disabled]	
TS on DIMM	[Disabled]	
Boots Graphic Adapter Priority	[PEG/PCI]	
Internal Graphics Mode Select	[Enabled, 32MB]	
Max TOLUD	[3G Bytes]	
Gfx Low Power Mode	[Disabled]	
<b>PEG Port Configuration</b>		
PEG Port	[Auto]	
▶ Display Control		
		← Select Screen
		↑↓ Select Item
		+− Change Option
		F1 General Help
		F10 Save and Exit
		ESC Exit
v02.69 <C>Copyright 1985-2010, American Megatrends, Inc.		

Feature	Option	Description
DRAM Frequency	Auto 800Mhz 1067Mhz	Selects the DRAM frequency
Configure DRAM Timing by SPD	Disabled Enabled	Disables and Enables automatic DRAM configuration via SPD EEPROM
TMRC Mode	Disabled Enabled	Disables and Enables the thermal memory reference code.
TM Lock	Disabled Enabled	Disables and Enables the Thermal Sensor on Lock.
TS on DIMM	Disabled Enabled	Disables and Enables the Thermal Sensor on DIMM.
Boots Graphic Adapter Priority	IGD PCI/IGD PCI/PEG PEG/IGD PEG/PCI	Selects which graphics adapter is initialized during boot up and gets priority
Internal Graphics Mode Select	Disabled Enabled, 32MB Enabled, 64MB Enabled, 128MB	Select the mode for the internal graphic device
Max TOLUD	3G Bytes 2.5G Bytes 2G Bytes	Maximum value of "top of low usable DRAM"
Gfx Low Power Mode	Disabled Enabled	Disables and Enables the low power mode for the internal graphics device
PEG Port	Auto Disabled Enable PEG Port Always	Selects the initialization mode of the PCIexpress graphics port

## Display Control

BIOS SETUP UTILITY		Chipset
JDA Revision : 1.11 UBIOS Revision : 1744 JILI Core Revision : 1.1.1		This setting is only
DVMT/FIXED Memory [256MB] PAVP Mode [Disabled]		
Boot Display Device [CRT + LVDS]		
▶ Internal LVDS Configuration		
TU Standard [NTSC] TU Sub-Type [NTSC-M]		← Select Screen ↑↓ Select Item +- Change Option F1 General Help F10 Save and Exit ESC Exit
HDMI DP Support [Disabled] HDCP Support [Disabled]		
v02.61 (C)Copyright 1985-2006, American Megatrends, Inc.		

Feature	Option	Description
DVMT/FIXED Memory	128MB 256MB \Max DVMT	Configures the amount of memory for the Dynamic Video Memory Technology
PAVP Mode	Disabled Light High	Configures the Protected Audio Video Path
Boot Display Device	CRT TV SDVO CRT+SDVO LVDS CRT+LVDS	Selects the Boot Display Devices
TV Standard	NTSC PAL SECAM SMPTE240M ITU-R television SMPTE295M SMPTE296M EIA-770.2 EIA-770.3	Selects the regarding TV standard for TV out interface
TV Sub-Type	Depending on TV Standard	Selects the regarding TV Sub-Type
HDMI DP Support	Disabled Enabled	Enables and disables the HDMI DP Support
HDCP Support	Disabled Enabled	Enables and disables the HDCP Support

## Internal LVDS Configuration

Chipset	
<b>Current LVDS Configuration</b> Data Source : NONE Resolution : N/A Color Depth : N/A Channel Count : N/A  Flat Panel Mode [Auto] Auto Fallback [Disabled] PAID/FPID [ 5 ] Local Flat Panel Scaling [Stretched] LVDS -> DVI ID [ A ] Backlight Control Type [I2C] Backlight Brightness [128]	<b>Options</b>  Auto Fixed Mode PAID FPID  ← Select Screen ↑↓ Select Item +- Change Option F1 General Help F10 Save and Exit ESC Exit
v02.69 <C>Copyright 1985-2010, American Megatrends, Inc.	

Feature	Option	Description
Flat Panel Mode	<b>Auto</b> Fixed Mode PAID FPID	Selects the Mode for the flat panel detection
Auto Fallback	<b>Disabled</b> Fixed Mode	Selects what happens, when there is no EEPROM detected (only when FPM: Auto)
Flat Panel Type	<b>VGA 640×480</b> ... WXGA 1280×800	Selects the resolution of the LVDS display (only in FPM: Fixed Mode)
PAID/FPID	[X]	Selects the number of the PAID/FPID
Channels	<b>Single Channel</b> Dual Channel	Selects, if 1x or 2x LVDS signals are used (only in FPM: Fixed Mode)
Color Depth	<b>18bit</b> 24bit open LDI 24bit	Selects the Color Depth of the connected LVDS display (only in FPM: Fixed Mode)
Local Flat Panel Scaling	Centered <b>Stretched</b> Disabled	Selects the Scaling Options for the LVDS panel (only in FPM: Fixed Mode)
Backlight Control Type	None/External <b>I2C</b> PWM	Selects the mode for Backlight Control
Backlight Brightness	[0...255]	Selects the default setting for Backlight Brightness

## Southbridge Configuration

BIOS SETUP UTILITY		Chipset
<b>South Bridge Configuration</b>		<b>Enable/disable USB ports.</b>
USB Functions	[8 USB Ports + IDE]	<b>Note:</b> The parallel ATA channel is hosted by an USB2ATA bridge at the 9th USB port. Disabling this port will also disable parallel ATA!
USB Port Configure	[6+4 USB Ports]	
USB 2.0 Controller	[Enabled]	
Enable Lock Bit	[Enabled]	
Port 80h Output	[LPC]	
Audio Controller	[Enabled]	
SMBUS Controller	[Enabled]	
▶ LPC Decode Range		
		← Select Screen ↑↓ Select Item +- Change Option F1 General Help F10 Save and Exit ESC Exit
v02.61 (C)Copyright 1985-2006, American Megatrends, Inc.		

Feature	Option	Description
USB Functions	Disabled 2 USB Ports 4 USB Ports ... <b>8 USB Ports + IDE</b>	Enables / Disables USB ports*
USB Port Configure	<b>6+4 USB Ports</b> 8+2 USB Ports	Configures, how the ports are mapped internally to the USB controllers
USB 2.0 Controller	<b>Enabled</b> Disabled	Enables / Disables the USB 2.0 controller. (only available when there is USB2ATA port disabled)
Enable Lock Bit	Disabled <b>Enabled</b>	Enables Lock bit at end of POST. Only disable for debugging purposes.
Port 80h Output	<b>LPC</b> PCI	Selects the Interface for Port 80h output during POST
Audio Controller	<b>Enabled</b> Disabled	Enables / Disables the HDA audio controller
SMBUS Controller	<b>Enabled</b> Disabled	Enables / Disables the SMBus controller



\* The parallel ATA channel is hosted by an USB2PATA bridge at the 9th USB port. Disabling this port will also disable parallel ATA!



## LPC Decode Range

BIOS SETUP UTILITY		Chipset
<b>LPC Decode Range</b> <hr/> LPC Decode Range 1 Base [ 0 ] LPC Decode Range 1 Size [Disabled] LPC Decode Range 2 Base [ 0 ] LPC Decode Range 2 Size [Disabled] LPC Decode Range 3 Base [ 0 ] LPC Decode Range 3 Size [Disabled] <hr/> LPC Decode Range 4Eh/4Fh [Enabled] LPC Decode Range 62h/66h [Disabled]		Enable the range to be forwarded to the LPC I/F  ← Select Screen ↑↓ Select Item Enter Update F1 General Help F10 Save and Exit ESC Exit
v02.61 (C)Copyright 1985-2006, American Megatrends, Inc.		

Feature	Option	Description
LPC Decode Range 1 Base	[0...FFFF]	Enter the Base Adress of the LPC decode range
LPC Decode Range 1 Size	Disabled 4 8 ... 256	Size of the decode range in kB
LPC Decode Range 2 Base	[0...FFFF]	Enter the Base Adress of the LPC decode range
LPC Decode Range 2 Size	Disabled 4 8 ... 256	Size of the decode range in kB
LPC Decode Range 3 Base	[0...FFFF]	Enter the Base Adress of the LPC decode range
LPC Decode Range 3 Size	Disabled 4 8 ... 256	Size of the decode range in kB
LPC Decode Range 4Eh/4Fh	Enabled Disabled	Enables disables the LPC decode range at 4Eh/4Fh
LPC Decode Range 62h/66h	Disabled Enabled	Enables disables the LPC decode range at 62h/66h

## 8.4.8 Exit Menu

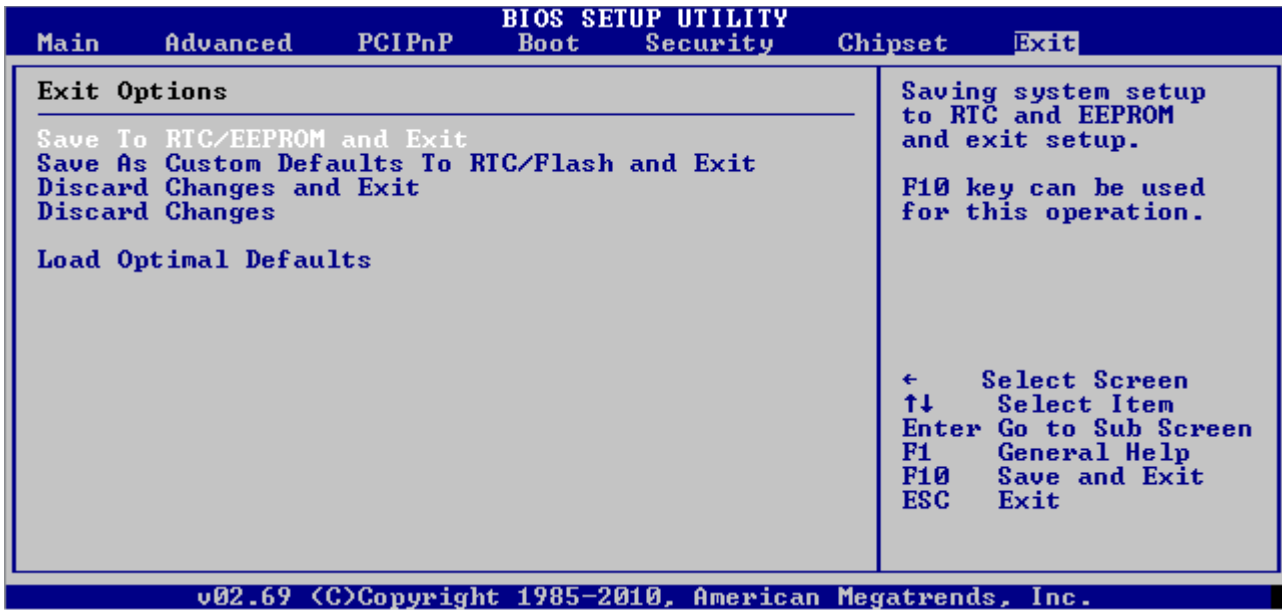

## Corporate Offices

<p><b>Europe, Middle East &amp; Africa</b>            Oskar-von-Miller-Str. 1            85386 Eching/Munich            Germany            Tel.: +49 (0)8165/ 77 777            Fax: +49 (0)8165/ 77 219  <a href="mailto:info@kontron.com">info@kontron.com</a></p>	<p><b>North America</b>            14118 Stowe Drive            Poway, CA 92064-7147            USA            Tel.: +1 888 294 4558            Fax: +1 858 677 0898  <a href="mailto:info@us.kontron.com">info@us.kontron.com</a></p>	<p><b>Asia Pacific</b>            17 Building, Block #1, ABP.            188 Southern West 4th Ring            Beijing 100070, P.R.China            Tel.: + 86 10 63751188            Fax: + 86 10 83682438  <a href="mailto:info@kontron.cn">info@kontron.cn</a></p>	
--	--	---	---