**Premium Duty QMW, Heavy Duty QMR**

Individual Components.....	7-2
Factory Assembled Fuse Clips .....	7-4

**Handle Operators**

Product Ordering Tables .....	7-7
Accessories and Modifications .....	7-8

**General-Duty HCI**

Factory Assembled Fuse Clips.....	7-10
Individual Components.....	7-11

**TDR Handle Mechanism**

Handle Operating Mechanisms.....	7-14
----------------------------------	------

**HPC High-Pressure Contact Switch**

Top- or Bottom Feed.....	7-15
Integral Ground Fault Devices.....	7-17
Accessories.....	7-19
Application Information.....	7-20

**FD1 Fusible IEC Style**

Individual Components.....	7-21
Accessories.....	7-22
Outlines and Dimensions.....	7-24

**DILOS Nonfusible Vu-Break IEC Style**

Individual Components.....	7-25
Accessories.....	7-26
Outlines and Dimensions.....	7-27



# Disconnect Switches and Operating Mechanisms

## --Premium Duty QMW, Heavy Duty QMR

## Section 7

Individual Components

30-200 Amperes

240, 480, 600 Vac, 250 Vdc

### Product Description

QMR and QMW switches (30-200 amperes), fuse and no-fuse kits are UL Recognized Components, File E-36152, and UL Recognized to Canadian safety requirements under the Component Recognition Program of Underwriters Laboratories Inc.

The 30-200 ampere fusible switches are UL Recognized for use on circuits capable of delivering not more than 200,000 rms symmetrical amperes at 240 or 600Vac when fused with Class R rated size fuses. Refer to the table 7-3 for the appropriate Class R Fusing Kit. They are suitable for use with Type STDA flange handles and variable depth operating mechanisms on page 7-7.

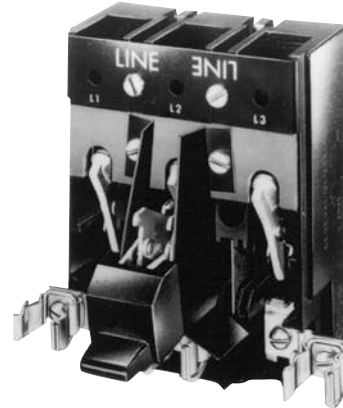

**QMW Premium Heavy-Duty Switch**  
(with Fuse Clips from Fuse Kit)

### Basic Switches - Premium Duty (QMW) and Heavy Duty (QMR)

Duty Type	Ampere Rating	Interrupting Rating Amperes Symmetrical 600Vac, 3-phase	Product Number	List Price GO-139
Premium Duty - QMW	30A	950	THMC31 <sup>1</sup>	\$218.00
Premium Duty - QMW	60A	1700	THMC32 <sup>1</sup>	\$252.00
Premium Duty - QMW	100A	1800	THMC33 <sup>1</sup>	\$464.00
Premium Duty - QMW	200A	3600	THMC34	\$755.00
Heavy Duty - QMR	30A	420	THMS31 <sup>1</sup>	\$199.00
Heavy Duty - QMR	60A	900	THMS32 <sup>1</sup>	\$227.00
Heavy Duty - QMR	100A	1700	THMS33 <sup>1</sup>	\$396.00
Heavy Duty - QMR	200A	3400	THMS34	\$672.00

Handle Operator: Order from pages 7-7 or 7-8.

<sup>1</sup>Specify special screw kit if load risers are to be fastened from underside of base. Two screws required per switch; 10 screws in each product number THMC1 kit,

List Price \$15.00, GO-139.



# Disconnect Switches and Operating Mechanisms Premium Duty QMW, Heavy Duty QMR (continued)

## Section 7

Individual Components

30-200 Amperes

240, 480, 600 Vac, 250 Vdc

### Fuse and No-Fuse Kits — Horsepower Ratings 3-pole

Product Number	Description of Kit	HP Rating, AC, 3-Phase, NEC Std. Fuse @ 240Vac	HP Rating, AC, 3-Phase, NEC Std. Fuse @ 480Vac	HP Rating, AC, 3-Phase, NEC Std. Fuse @ 600Vac	HP Rating, AC, 3-Phase, Time-Delay Fuse @ 240Vac	HP Rating, AC, 3-Phase, Time-Delay Fuse @ 480Vac	HP Rating, AC, 3-Phase, Time-Delay Fuse @ 600Vac	HP Rating, 125Vdc	HP Rating, 250Vdc
THMC3100	No Fuse	-	-	-	7.5	20	25	3	5
THMC3200	No Fuse	-	-	-	20	40	50	5	10
THMC3300	No Fuse	-	-	-	30	60	75	-	20
THMC3400	No Fuse	-	-	-	60	125	150	-	40
THMC3121	30A, 240Vac/250Vdc	3	-	-	7.5	-	-	3	5
THMC3222	60A, 240Vac/250Vdc	5	-	-	15	-	-	5	10
THMC3161	30A, 600Vac	-	5	7.5	-	15	20	3	5
THMC3262	60A, 600Vac	-	15	20	-	40	50	5	10
THMC3363	100A, 240Vac/250Vdc 100A, 600Vac	10	25	30	30	60	75	-	20
THMC3364	200 A, 600Vac	25	50	60	-	-	-	-	-
THMC3464	200A, 240Vac/250Vdc 200A, 600Vac	25	50	60	60	125	150	-	40
THMC3465	400A, 600Vac	50	100	125	-	-	-	-	-

### Fuse and No-Fuse Kits (Includes load block, clips, and lugs)

Product Number	Description of Kit	Switch Product Number	Fuse Type	No. of Poles	Lug Wire Size	List Price GO-139
THMC3100 <sup>2</sup>	No Fuse	THMC31 or THMS31	No Fuse	3	Wire Keeper Term. for #14-8 CU	\$7.00
THMC3200	No Fuse	THMC32 or THMS32	No Fuse	3	CU 14-2 AL 12-2	\$11.50
THMC3300	No Fuse	THMC33 or THMS33	No Fuse	3	CU 14-0 AL 12-0	\$17.00
THMC3400	No Fuse	THMC34 or THMS34	No Fuse	3	6-250 kcmil CU-AL	\$37.50
THMC3121 <sup>1</sup>	30A, 240Vac/250Vdc	THMC31 or THMS31	NEC Standard	3	Wire Keeper Term. for #14-8 CU	\$31.50
THMC3222 <sup>1</sup>	60A, 240Vac/250Vdc	THMC31 or THMS31	NEC Standard	3	Wire Keeper Term. for #14-8 CU	\$41.00
THMC3161 <sup>1</sup>	30A, 600Vac	HMC31 or THMS31	NEC Standard and Class J	3	Wire Keeper Term. for #14-8 CU	\$41.00
THMC3262 <sup>1</sup>	60A, 600Vac	THMC31 or THMS31	NEC Standard and Class J	3	Wire Keeper Term. for #14-8 CU	\$60.50
THMC3363	100A, 240Vac/250Vdc 100A, 600Vac	THMC32 or THMS32	NEC Standard and Class J	3	CU 14-2 AL 12-2	\$140.00
THMC3364	200A, 600Vac	THMC33 or THMS33	NEC Standard and Class J	3	CU 14-0 AL 12-0	\$261.00
THMC3464	200A, 240Vac/250Vdc 200A, 600Vac	THMC34 or THMS34	NEC Standard and Class J	3	6-250 kcmil CU-AL	\$343.00
THMC3465	400A, 600Vac	THMC34 or THMS34	NEC Standard and Class J	3	6-250 kcmil CU-AL	\$498.00

No-fuse ratings indicate switch capability as permitted by UL 508 (Ind. Cont. Equip.), additional hp ratings correspond to commercially available fuses. For DC use outer poles.

<sup>1</sup>Can be used for one-step underfusing for next higher current-rated disconnect.

<sup>2</sup>Maximum UL listing 20 hp. at 600V.



# Disconnect Switches and Operating Mechanisms

## Premium Duty QMW, Heavy Duty QMR

## Section 7

Factory Assembled Fuse Clips  
Choice of Handle Style  
30-600 Amperes  
240, 480, 600 Vac, 250 Vdc

### Product Description

These 30-600 ampere disconnect switches are complete with Class H fuse clips except where noted, line/load lugs and handle operators, all factory assembled, and are mounted on a heavy-gauge steel backplate. They are UL Recognized Components, File E-36152, and UL Recognized to Canadian safety requirements under the Component Recognition Program of Underwriters Laboratories Inc.

The 30-200 ampere fusible switches are UL Recognized for use on circuits capable of delivering not more than 200,000 rms symmetrical amperes at 240 or 600Vac when fused with Class R rated size fuses. Refer to the table below for the appropriate Class R Fusing Kit. Class H Fuse Clips are standard. Suitable for NEMA 1 and NEMA 12 enclosures.



QMR Disconnect with TDR Handle

### Assembled with Lugs, Fuse Clips and Handle Operators – Horsepower Ratings

Duty Type	Disconnect Switch Rating (Amperes)	Max. HP Rating @ 240Vac 3-Phase	Max. HP Rating @ 480Vac 3-Phase	Max. HP Rating @ 600Vac 3-Phase	Max. HP Rating @ 250 Vdc	Product Number
Heavy Duty – QMR	30A	7.5	20	20	5	THMR3100
Heavy Duty – QMR	30A	7.5	-	-	5	THMR3121
Heavy Duty – QMR	30A	7.5	15	20	5	THMR3161
Heavy Duty – QMR	60A	20	40	50	10	THMR3200
Heavy Duty – QMR	60A	15	-	-	10	THMR3222
Heavy Duty – QMR	60A	-	30	50	10	THMR3262
Heavy Duty – QMR	100A	30	60	75	20	THMR3300
Heavy Duty – QMR	100A	30	60	75	20	THMR3363 <sup>1</sup>
Heavy Duty – QMR	200A	60	125	150	40	THMR3400
Heavy Duty – QMR	200A	60	125	150	40	THMR3464 <sup>1</sup>
Heavy Duty – QMR	400A	125	250	350	50	THMA35NF
Heavy Duty – QMR	400A	125	-	-	50	THMA3525
Heavy Duty – QMR	400A	125	250	350	-	THMA3565
Heavy Duty – QMR	400A	125	250	350	-	THMA35J5 <sup>2</sup>
Heavy Duty – QMR	400A	125	250	350	50	THMRB35NF
Heavy Duty – QMR	400A	125	-	-	50	THMRB3525
Heavy Duty – QMR	400A	125	250	350	-	THMRB3565
Heavy Duty – QMR	400A	125	250	350	-	THMRB35J5 <sup>2</sup>
Heavy Duty – QMR	600A	200	400	500	50	THMA36NF
Heavy Duty – QMR	600A	200	400	500	-	THMA3665
Heavy Duty – QMR	600A	200	-	-	50	THMA3626
Heavy Duty – QMR	600A	200	400	500	-	THMA3666 <sup>3</sup>
Heavy Duty – QMR	600A	200	400	500	-	THMA36J6 <sup>2</sup>
Heavy Duty – QMR	600A	200	400	500	-	THMA36L7 <sup>4</sup>
Heavy Duty – QMR	600A	200	400	500	50	THMRB36NF
Heavy Duty – QMR	600A	200	400	500	-	THMRB3665
Heavy Duty – QMR	600A	200	-	-	50	THMRB3626
Heavy Duty – QMR	600A	200	400	500	-	THMRB3666 <sup>3</sup>
Heavy Duty – QMR	600A	200	400	500	-	THMRB36J6 <sup>2</sup>
Heavy Duty – QMR	600A	200	400	500	-	THMRB36L7 <sup>4</sup>
Premium Duty – QMW	30A	7.5	20	20	5	THMCR3100
Premium Duty – QMW	30A	7.5	-	-	5	THMCR3121
Premium Duty – QMW	30A	7.5	15	20	5	THMCR3161
Premium Duty – QMW	60A	20	40	50	10	THMCR3200
Premium Duty – QMW	60A	15	-	-	10	THMCR3222
Premium Duty – QMW	60A	-	30	50	10	THMCR3262
Premium Duty – QMW	100A	30	60	75	20	THMCR3300
Premium Duty – QMW	100A	30	60	75	20	THMCR3363
Premium Duty – QMW	200A	60	125	150	40	THMCR3400
Premium Duty – QMW	200A	60	125	150	40	THMCR3464

400 and 600 Ampere QMR units are UL Recognized on 100,000 Ampere rms circuits when fused with rated size Class J or R fuses.

Order Door Ring Interlock Kit—343L483G4; **List Price \$21.75, GO-144.** Gasket Kit—792A489G3, **List Price, \$11.00, GO-144.**

400 and 600 Ampere switches with TDM handle have “pendulum” operation.

400 and 600 Ampere QMR units are UL Recognized on 100,000 Ampere rms circuits when fused with rated size Class J or R fuses.

<sup>1</sup>Field convertible to 250 Volt fusing.

<sup>2</sup>Supplied with Class J fuse clips.

<sup>3</sup>600 Ampere, 600 Volt Class H fused to Class J fusing. Order kit Product Number THJ6, **List Price \$420.00, GO-131.** One kit required per switch. 400 Ampere units can be field converted by moving the fuse block toward the switch.

<sup>4</sup>Supplied with Class L fuse clips.



# Disconnect Switches and Operating Mechanisms Premium Duty QMW, Heavy Duty QMR (continued)

## Section 7

Factory Assembled Fuse Clips

Choice of Handle Style

30-600 Amperes

240, 480, 600 Vac, 250 Vdc

### Assembled Switches with Lugs, Fuse Clips and Handle Operators

Duty Type	Ampere Rating	Fuse Clip Rating (Ampere) @ 250Vdc Max.	Fuse Clip Rating (Ampere) @ 600Vac Max.	Handle Style	Lug Wire Size	Product Number	List Price GO-139
Heavy Duty - QMR	30A	No Fuse	No Fuse	TDR Rotary Handle	Wire Keeper, Term. for #14-8 Cu	THMR3100	\$252.00
Heavy Duty - QMR	30A	30	-	TDR Rotary Handle	Wire Keeper, Term. for #14-8 Cu	THMR3121	\$284.00
Heavy Duty - QMR	30A	-	30	TDR Rotary Handle	Wire Keeper, Term. for #14-8 Cu	THMR3161	\$301.00
Heavy Duty - QMR	60A	No Fuse	No Fuse	TDR Rotary Handle	CU 14-2 AL 12-2	THMR3200	\$286.00
Heavy Duty - QMR	60A	60	-	TDR Rotary Handle	CU 14-2 AL 12-2	THMR3222	\$331.00
Heavy Duty - QMR	60A	-	60	TDR Rotary Handle	CU 14-2 AL 12-2	THMR3262	\$360.00
Heavy Duty - QMR	100A	No Fuse	No Fuse	TDR Rotary Handle	10-1/0 Cu/Al	THMR3300	\$422.00
Heavy Duty - QMR	100A	100	100	TDR Rotary Handle	10-1/0 Cu/Al	THMR3363 <sup>1</sup>	\$572.00
Heavy Duty - QMR	200A	No Fuse	No Fuse	TDR Rotary Handle	6-250 kcmil Cu/Al	THMR3400	\$856.00
Heavy Duty - QMR	200A	200	200	TDR Rotary Handle	6-250 kcmil Cu/Al	THMR3464 <sup>1</sup>	\$1028.00
Heavy Duty - QMR	400A	No Fuse	No Fuse	TDM Adjustable Shaft Handle	(1) # 22-600 kcmil Cu/Al or (2) 1/0-3/0 Cu or (2) 1/0-250 kcmil Al	THMA35NF	\$1938.00
Heavy Duty - QMR	400A	400	-	TDM Adjustable Shaft Handle	(1) # 22-600 kcmil Cu/Al or (2) 1/0-3/0 Cu or (2) 1/0-250 kcmil Al	THMA3525	\$2410.00
Heavy Duty - QMR	400A	-	400	TDM Adjustable Shaft Handle	(1) # 22-600 kcmil Cu/A or (2) 1/0-3/0 Cu or (2) 1/0-250 kcmil Al	THMA3565	\$2410.00
Heavy Duty - QMR	400A	-	400	TDM Adjustable Shaft Handle	(1) # 22-600 kcmil Cu/Al or (2) 1/0-3/0 Cu or (2) 1/0-250 kcmil Al	THMA35J5 <sup>2</sup>	\$2410.00
Heavy Duty - QMR	400A	No Fuse	No Fuse	TDR Rotary Handle	(1) # 22-600 kcmil Cu/Al or (2) 1/0-3/0 Cu or (2) 1/0-250 kcmil Al	THMRB35NF	\$1938.00
Heavy Duty - QMR	400A	400	-	TDR Rotary Handle	(1) # 22-600 kcmil Cu/Al or (2) 1/0-3/0 Cu or (2) 1/0-250 kcmil Al	THMRB3525	\$2410.00
Heavy Duty - QMR	400A	-	400	TDR Rotary Handle	(1) # 22-600 kcmil Cu/Al or (2) 1/0-3/0 Cu or (2) 1/0-250 kcmil Al	THMRB3565	\$2410.00
Heavy Duty - QMR	400A	-	400	TDR Rotary Handle	(1) # 22-600 kcmil Cu/Al or (2) 1/0-3/0 Cu or (2) 1/0-250 kcmil Al	THMRB35J5 <sup>2</sup>	\$2410.00
Heavy Duty - QMR	600A	No Fuse	No Fuse	TDM Adjustable Shaft Handle	(2) # 4-600 kcmil Cu/Al	THMA36NF	\$2521.00
Heavy Duty - QMR	600A	400	400	TDM Adjustable Shaft Handle	(2) # 4-600 kcmil Cu/Al	THMA3665	\$3265.00
Heavy Duty - QMR	600A	600	-	TDM Adjustable Shaft Handle	(2) # 4-600 kcmil Cu/Al	THMA3626	\$3265.00
Heavy Duty - QMR	600A	-	600	TDM Adjustable Shaft Handle	(2) # 4-600 kcmil Cu/Al	THMA3666 <sup>3</sup>	\$3265.00
Heavy Duty - QMR	600A	-	600	TDM Adjustable Shaft Handle	(2) # 4-600 kcmil Cu/Al	THMA36J6 <sup>2</sup>	\$3265.00
Heavy Duty - QMR	600A	-	800	TDM Adjustable Shaft Handle	(2) # 4-600 kcmil Cu/Al	THMA36L7 <sup>4</sup>	\$3388.00
Heavy Duty - QMR	600A	No Fuse	No Fuse	TDR Rotary Handle	(2) # 4-600 kcmil Cu/Al	THMRB36NF	\$2521.00
Heavy Duty - QMR	600A	400	400	TDR Rotary Handle	(2) # 4-600 kcmil Cu/Al	THMRB3665	\$3265.00
Heavy Duty - QMR	600A	600	-	TDR Rotary Handle	(2) # 4-600 kcmil Cu/Al	THMRB3626	\$3265.00
Heavy Duty - QMR	600A	-	600	TDR Rotary Handle	(2) # 4-600 kcmil Cu/Al	THMRB3666 <sup>3</sup>	\$3265.00
Heavy Duty - QMR	600A	-	600	TDR Rotary Handle	(2) # 4-600 kcmil Cu/Al	THMRB36J6 <sup>2</sup>	\$3265.00
Heavy Duty - QMR	600A	-	800	TDR Rotary Handle	(2) # 4-600 kcmil Cu/Al	THMRB36L7 <sup>4</sup>	\$3388.00

400 and 600 Ampere QMR units are UL Recognized on 100,000 Ampere rms circuits when fused with rated size Class J or R fuses.

Order Door Ring Interlock Kit—343L483G4; List Price \$21.75, GO-144. Gasket Kit—792A489G3, List Price, \$11.00, GO-144.

400 and 600 Ampere switches with TDM handle have "pendulum" operation.

400 and 600 Ampere QMR units are UL Recognized on 100,000 Ampere rms circuits when fused with rated size Class J or R fuses.

<sup>1</sup>Field convertible to 250 Volt fusing.

<sup>2</sup>Supplied with Class J fuse clips.

<sup>3</sup>600 Ampere, 600 Volt Class H fused to Class J fusing. Order kit Product Number THJ6, List Price \$420.00, GO-131. One kit required per switch. 400 Ampere units can be field converted by moving the fuse block toward the switch.

<sup>4</sup>Supplied with Class L fuse clips.



# Disconnect Switches and Operating Mechanisms Premium Duty QMW, Heavy Duty QMR (continued)

## Section 7

Factory Assembled Fuse Clips

Choice of Handle Style

30-600 Amperes

240, 480, 600 Vac, 250 Vdc

### Assembled Switches with Lugs, Fuse Clips and Handle Operators (Continued)

Duty Type	Ampere Rating	Fuse Clip Rating (Ampere) @ 250Vdc Max.	Fuse Clip Rating (Ampere) @ 600Vac Max.	Handle Style	Lug Wire Size	Product Number	List Price GO-139
Premium Duty – QMW	30A	No Fuse	No Fuse	TDR Rotary Handle	Wire Keeper, Term. for #14-8 Cu	THMCR3100	\$273.00
Premium Duty – QMW	30A	30	–	TDR Rotary Handle	Wire Keeper, Term. for #14-8 Cu	THMCR3121	\$303.00
Premium Duty – QMW	30A	–	30	TDR Rotary Handle	Wire Keeper, Term. for #14-8 Cu	THMCR3161	\$324.00
Premium Duty – QMW	60A	No Fuse	No Fuse	TDR Rotary Handle	CU 14-2 AL 12-2	THMCR3200	\$331.00
Premium Duty – QMW	60A	60	–	TDR Rotary Handle	CU 14-2 AL 12-2	THMCR3222	\$367.00
Premium Duty – QMW	60A	–	60	TDR Rotary Handle	CU 14-2 AL 12-2	THMCR3262	\$405.00
Premium Duty – QMW	100A	No Fuse	No Fuse	TDR Rotary Handle	10-1/0 Cu/Al	THMCR3300	\$479.00
Premium Duty – QMW	100A	100	100	TDR Rotary Handle	10-1/0 Cu/Al	THMCR3363	\$619.00
Premium Duty – QMW	200A	No Fuse	No Fuse	TDR Rotary Handle	6-250 kcmil Cu/Al	THMCR3400	\$967.00
Premium Duty – QMW	200A	200	200	TDR Rotary Handle	6-250 kcmil Cu/Al	THMCR3464	\$1130.00

400 and 600 Ampere QMR units are UL Recognized on 100,000 Ampere rms circuits when fused with rated size Class J or R fuses.

Order Door Ring Interlock Kit—343L483G4; **List Price \$21.75, GO-144.** Gasket Kit—792A489G3, **List Price, \$11.00, GO-144.**

400 and 600 Ampere switches with TDM handle have "pendulum" operation.

400 and 600 Ampere QMR units are UL Recognized on 100,000 Ampere rms circuits when fused with rated size Class J or R fuses.

<sup>1</sup>Field convertible to 250 Volt fusing.

<sup>2</sup>Supplied with Class J fuse clips.

<sup>3</sup>600 Ampere, 600 Volt Class H fused to Class J fusing. Order kit Product Number THJ6, **List Price \$420.00, GO-131.** One kit required per switch. 400 Ampere units can be field converted by moving the fuse block toward the switch.

<sup>4</sup>Supplied with Class L fuse clips.

### Class R Fusing Conversion Kits

Switch Rating		Field Installed	
Amperes	Volts	Product Number	List Price For GO, see footnotes
30	250Vdc	TPBRK12A	\$35.00 <sup>2</sup>
30	600Vac	TPBRK16A	\$35.00 <sup>2</sup>
60	250Vdc	TPBRK22A	\$35.00 <sup>2</sup>
60	600Vac	TPBRK26A	\$35.00 <sup>2</sup>
100	250Vdc/600Vac	TPBRK36A	\$35.00 <sup>2</sup>
200	250Vdc/600Vac	TRK46A	\$43.25 <sup>3</sup>
400	250Vdc/600Vac	TPBRK56A <sup>1</sup>	\$73.50 <sup>2</sup>
600	250Vdc/600Vac	TRK66A <sup>1</sup>	\$74.00 <sup>3</sup>

<sup>1</sup>Not suitable for use with individual components shown on pages 7-2 and 7-3.

<sup>2</sup>GO-143.

<sup>3</sup>GO-131



### Product Description

#### Type STDA Flange Handles and Variable Depth Operating Mechanisms For Use With QMR/QMW 30-200A Disconnects

- Designed to meet automotive duty specifications.
- NEMA 12/13 and 4/4X, UL Recognized Components, File E-57253, and UL Recognized to Canadian safety requirements under the Component Recognition Program of Underwriters Laboratories Inc.
- For right- or left-hand flange mounting—field convertible.
- Mounting dimensions to fit standard flange enclosures 8"-24" deep.
- Drilling templates and detailed installation instructions.

### Flange Handle Selection

Product Number STDA1 (6-inch) and STDA2 (10-inch) flange handles are interchangeable. While all operating mechanisms can be easily operated with the 6-inch STDA1 handle, the 10-inch STDA2 may be used to obtain lower operating force and/or to provide a proportionally larger handle on large enclosures.



Flange Handle, STDA1

### Construction Details

#### Flange Handles

- Rugged aluminum alloy cast housing with provision for locking in off position with up to three 3/16- to 5/16-inch diameter padlocks.
- Optional provision for locking on by drilling hole in die casting.
- O-ring seals for dust-tight/oil-tight duty.
- Gusseted, 3/32-in. thick double-sided steel handle with large, red-black self-extinguishing grade plastic grip.

#### Variable Depth Operating Mechanisms

- Plated steel yokes and integral mounting plates are 1/8-inch thick minimum.
- Operating yokes have toggle spring assist for positive on/off operation.
- Mounting plates include positive yoke stops to prevent undue wear on disconnect and circuit breaker toggle handles.
- Threaded 3/8-in. dia. drive rod (16-in. length—standard, 22-in. length—optional) provides simple variable depth connection between flange-mounted handle and operating mechanism.
- Suitable for use with Hoffman Bulletin A-25 or equivalent enclosures.

### Flange Handles

Enclosure Type	Nominal Length (Inches)	Installation Instruction Number	Drilling Template Number	Product Number	List Price GO-144A
NEMA Type 12/13	6	GEH-5314	GEH-5314	STDA1	\$82.50
NEMA Type 12/13	10	GEH-5314	GEH-5314	STDA2	\$94.50
NEMA Type 4/4X	6	GEH-5314	GEH-5314	STDA1X	\$148.00
NEMA Type 4/4X	10	GEH-5314	GEH-5314	STDA2X	\$165.00

### Operating Mechanism Selection

Disconnect Description	QMR/QMW/ Flange Handle Product Number	Operating Mechanism Installation Instruction No.	Product Number	List Price GO-144A
30-100A unfused; 30A-250V fused	STDA1, 1X or STDA2, 2X	GEH-5315	TDOM1A	\$67.00
30-100A 600V fused; 60A & 100A 250V fused	STDA1, 1X or STDA2, 2X	GEH-5315	TDOM1B	\$76.50
200A fused or unfused	STDA1, 1X or STDA2, 2X	GEH-5316	TDOM2	\$76.50

Select individual QMR or QMW disconnect and fuse or no-fuse kit from page 7-3.



# Disconnect Switches and Operating Mechanisms Accessories and Modifications

## Section 7

For Type STDA Flange Handles and Operating Mechanisms

### Auxiliary Contact Kit

Available SPDT and DPDT and actuated by operating mechanism yoke.

Contacts	Used With Operating Mechanism Product Number	When TDA handle is on Right Flange	When TDA handle is on Left Flange	Product Number	List Price GO-144A
SPDT	TDOM1A, TDOM1B, TDOM2	•	–	TDAS1L1	<b>\$71.00</b>
SPDT	TDOM1A, TDOM1B, TDOM2	–	•	TDAS1R1	<b>\$71.00</b>
DPDT	TDOM1A, TDOM1B, TDOM2	•	–	TDAS1L2	<b>\$134.00</b>
DPDT	TDOM1A, TDOM1B, TDOM2	–	•	TDAS1R2	<b>\$134.00</b>

### Auxiliary Contact Electrical Ratings

Type	AC Voltage				DC Voltage Double Throw		
	120	240	480	600	120	240	600
1-Pole	40	20	20	8	0.5	0.2	.02
Make	15	10	6	5	0.5	0.2	.02
Break	30	15	8	6	0.2	0.1	—
2-Pole	3	1.5	1	0.8	0.2	0.1	—
Make							
Break							

### Flange Stiffener Kit, Extended Drive Rod

Provides rigid 3/8-inch diameter rod between STDA handle mounting surface (flange or center mullion) and operating mechanism when STDA handle would otherwise not be rigidly supported.

Rod length is 22 inches and may be cut to appropriate length. Also used as extended length drive rod when standard 16-inch rod is not long enough.

Used With Operating Mechanism Product Number	Product Number	List Price GO-144A
TDOM1A, 1B, TDOM2	TDSR	<b>\$29.50</b>

### Extended Drive Stud

This optional drive stud permits locating the operating mechanism 1 5/16 inches further to the left (when flange handle is on right side) or to the right (when handle is on left side) to accommodate specific mounting restrictions.

Used With Operating Mechanism Product Number	Product Number	List Price GO-144A
TDOM1A, TDOM1B, TDOM2	TDS1	<b>\$29.50</b>

### Door Hardware, NEMA 12/12 and 4/4X

Type TDV door hardware provides sealing and interlocking of 3/4-inch nominal door depth hinged on left or right. Interlocking design requires use of screwdriver to release. When used with STDA flange handle and operating mechanisms, disconnect or circuit breaker cannot be turned on unless door and door hardware have been closed. For noninterlocking type, one bracket in kit is not used. Use of third-point latch recommended for doors 40 inches or longer.

Accessory Type	Description	Product Number	List Price GO-144A
Door Hardware-Left Hinged	NEMA 12/13 two-point interlocking door hardware kit	TDV1	<b>\$134.00</b>
Door Hardware-Left Hinged	NEMA 4/4X two-point interlocking door hardware kit	TDV1X	<b>\$174.00</b>
Door Hardware-Left Hinged	Third-point latch kit for above	TDV3	<b>\$29.50</b>
Door Hardware-Right Hinged	NEMA 12/13 two-point interlocking door hardware kit	TDV1L	<b>\$134.00</b>
Door Hardware-Right Hinged	NEMA 4/4X two-point interlocking door hardware kit	TDV1LX	<b>\$174.00</b>
Door Hardware-Right Hinged	Third-point latch kit for above	TDV3L	<b>\$29.50</b>

### Agency Certifications

STDA accessories are UL Recognized Components, File E-36152, and UL Recognized to Canadian safety requirements under the Component Recognition Program of Underwriters Laboratories Inc.

### Reference Publications

Door Hardware	GEH-5322
Auxiliary Contact Kit	GEH-5323
Flange Stiffener Kit or Extended-Length Drive Rod	GEH-5324
Extended Drive Stud	GEH-5325
Operating Mechanism:	
TDOM1A through TDOM1B	GEH-5315
TDOM2	GEH-5316





### Overpack Kits

QMW disconnect switch, fuse kit with copper lugs, operating mechanism and STDA1 flange handle packed in a single carton.

### QMW with Copper Lugs for Copper Cables Only and Class R Rejection Clips for Class R Fusing

Ampere Rating	Fuse Clip Rating (Ampere)	System Voltage	Fuse Kit Prod. No. (or No-Fuse Kit Prod. No.)	Variable Depth Operating Mechanism Prod. No.	Product Number	List Price GO-139
30A	No Fuse	No Fuse	THMC3200CL	TDOM1A	STDAD3NF	\$284.00
30A	30	250Vdc	THMC3121CLR	TDOM1A	STDAD332R	\$344.00
30A	30	600Vac	THMC3161CLR	TDOM1B	STDAD336R	\$362.00
60A	No Fuse	No Fuse	THMC3200CL	TDOM1A	STDAD6NF	\$312.00
60A	60	250Vdc	THMC3222CLR	TDOM1B	STDAD662R	\$386.00
60A	60	600Vac	THMC3262CLR	TDOM1B	STDAD666R	\$413.00
100A	No Fuse	No Fuse	THMC3300CL	TDOM1A	STDAD1NF	\$424.00
		250Vdc				
100A	100	600Vac	THMC3363CLR	TDOM1B	STDAD100R	\$612.00
200A	No Fuse	No Fuse	THMC3400CL	TDOM2	STDAD2NF	\$833.00
		250Vdc				
200A	200	600Vac	THMC3464CLR	TDOM2	STDAD200R	\$975.00

### QMW with Copper Lugs for Copper Cables Only and Class J Clips for Class J Fusing

Ampere Rating	Fuse Clip Rating (Ampere)	System Voltage	Fuse Kit Prod. No. (or No-Fuse Kit Prod. No.)	Variable Depth Operating Mechanism Prod. No.	Product Number	List Price GO-139
30A	30	600Vac	THMC3161CL	TDOM1JA	STDAD336J	\$329.00
30A	60	600Vac	THMC3262CL	TDOM1JB	STDAD3362J	\$348.00
60A	60	600Vac	THMC3262CL	TDOM1JB	STDAD666J	\$379.00
60A	100	600Vac	THMC3363CL	TDOM1JA	STDAD6663J	\$460.00
100A	100	600Vac	THMC3363CL	TDOM1JA	STDAD106J	\$564.00
100A	200	600Vac	THMC3364CL	TDOM1A	STDAD1064J	\$685.00
200A	200	600Vac	THMC3464CL	TDOM2	STDAD206J	\$931.00
200A	400	600Vac	THMC3465	TDOM2	STDAD2065J	\$1278.00



# Disconnect Switches and Operating Mechanisms

## Section 7

### General-Duty HCI

Factory Assembled Fuse Clips  
TDM Door-Mounted Handle  
240, 480, 600 Vac, 250 Vdc

#### Product Description

These 30-200 ampere disconnect switches are complete with fuse clips and line/load lugs, both factory assembled, and over-packed NEMA 12 handle operators (TDM). They are listed in UL "Recognized Component Index" (WHTY2) for mounting in a vertical position, line side up. They provide 600 volt industrial control electrical spacings and are described in UL File E-36152. For units with 600 Volt enclosed switch spacings, select individual components from pages 7-11 to 7-14. They are suitable for use on circuits with available short-circuit currents to 10,000 amperes.

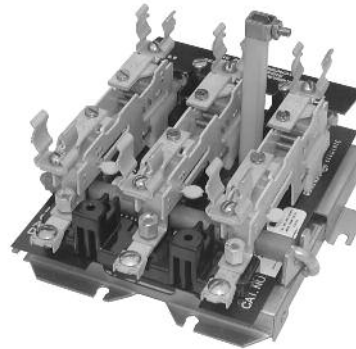

TH3161AFC Disconnect Switch

#### Assembled Switches with Lugs, Fuse Clips, Operating Shafts and Handle Operators Max. Horsepower Ratings

Disconnect Switch (Amperes)	Max. HP Rating <sup>1</sup> @ 240Vac 3-Phase	Max. HP Rating <sup>1</sup> @ 480Vac 3-Phase	Max. HP Rating <sup>1</sup> @ 600Vac 3-Phase	Max. HP Rating @ 250Vdc	Product Number
30A	7.5	15	20	5	THC3100AFC
30A	7.5	-	-	5	THC3121AFC
30A	-	15	20	5	THC3161AFC
60A	15	30	50	10	THC3200AFC
60A	15	-	-	10	THC3222AFC
60A	-	30	50	10	THC3262AFC
100A	30	60	75	20	THC3300AFC
100A	30	-	-	20	THC3323AFC
100A	-	60	75	20	THC3363AFC
200A	60	100	100	40	THC3400AFC
200A	60	-	-	40	THC3424AFC
200A	-	100	100	40	THC3464AFC

#### Assembled Switches with Lugs, Fuse Clips, Operating Shafts and Handle Operators<sup>2</sup>

Ampere Rating	Fuse Clip Rating (Ampere) @ 250Vdc Max.	Fuse Clip Rating (Ampere) @ 600Vac Max.	Lug Wire Size	Adjustable Handle Shaft Will Fit Enclosure Depths Min-Max <sup>3</sup>	Product Number	List Price GO-139
30A	No-Fuse—600V	No-Fuse—600V	#14-8 CU	5 1/16-7 15/16	THC3100AFC	\$295.00
30A	30	N/A	#14-8 CU	5 1/16-7 15/16	THC3121AFC	\$312.00
30A	N/A	30	#14-8 CU	5 1/16-7 15/16	THC3161AFC	\$329.00
60A	No-Fuse—600V	No-Fuse—600V	#14-2 CU	5 13/16-9 1/4 (5 9/16)	THC3200AFC	\$356.00
60A	60	N/A	#14-2 CU	5 13/16-9 1/4 (5 9/16)	THC3222AFC	\$405.00
60A	N/A	60	#12-2 AL	5 13/16-9 1/4 (5 9/16)	THC3262AFC	\$426.00
100A	No-Fuse—600V	No-Fuse—600V	#14 1/0 CU-AL	7 1/4-9 1/8 (6 7/16) <sup>4</sup>	THC3300AFC	\$587.00
100A	100	N/A	#14 1/0 CU-AL	7 1/4-9 1/8 (6 7/16) <sup>4</sup>	THC3323AFC	\$672.00
100A	N/A	100	#14 1/0 CU-AL	7 1/4-9 1/8 (6 7/16) <sup>4</sup>	THC3363AFC	\$672.00
200A	No-Fuse—600V	No-Fuse—600V	#6-250 kcmil CU-AL	9 1/4-14 3/4	THC3400AFC	\$916.00
200A	200	N/A	#6-250 kcmil CU-AL	9 1/4-14 3/4	THC3424AFC	\$1039.00
200A	N/A	200	#6-250 kcmil CU-AL	9 1/4-14 3/4	THC3464AFC	\$1083.00

<sup>1</sup>Maximum hp ratings for fusible units may require fuses with time-delay characteristics.

<sup>2</sup>For switch with under- or over-fusing, use individual components on pages 7-11 to 7-14.

<sup>3</sup>Handle and shaft provided are "pendulum" type. If "up-down" operation is required, order individual components.

<sup>4</sup>Inside enclosure depth may be reduced to these depths while maintaining electrical spacings—requires cutting handle shaft.



# Disconnect Switches and Operating Mechanisms

## General-Duty HCI

Individual Components  
30-200 Amperes  
240, 480, 600 Vac, 250 Vdc

### Basic Switch

Amperage Rating	No. of Poles	Product Number	List Price GO-139
30A	3	THC31 <sup>1</sup>	\$231.00
30A	3	THC31S <sup>2,4</sup>	\$242.00
60A	3	THC32 <sup>3</sup>	\$246.00
60A	3	THC32S <sup>2</sup>	\$259.00
100A	3	THC33 <sup>1</sup>	\$386.00
100A	3	THC33S <sup>2</sup>	\$405.00
200A	3	THC34 <sup>1</sup>	\$767.00
200A	3	THC34S <sup>2</sup>	\$806.00

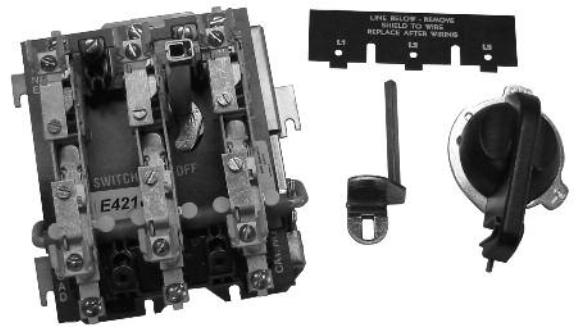

Auxiliary switch (SPDT) for HCI rated .5 ampere at 125Vdc, .25 ampere at 250Vdc, 15 ampere at 480Vac. Product Number 343L296G2, **List Price \$102.00, GO-139.**

HCI switches, fuse and no-fuse kits, are listed in UL "Recognized Component Index" (WHTY2) for mounting in a vertical position, line side up. UL File E-36152.

Line shield included with THC31 and THC31S. All other line shields included with fuse-clip or no-fuse kits.

For **Two-pole applications**—Use two poles of three-pole switch.

HCI switches, fuse and no-fuse kits, are listed in UL "Recognized Component Index" (WHTY2) for mounting in a vertical position, line side up. UL File E-36152.

Inside enclosure depth may be reduced to these depths while maintaining electrical spacings—requires cutting handle shaft.

<sup>1</sup>For basic switches with UL 600 Volt industrial control and 250 Volt enclosed switch and switchboard clearance spacings.

<sup>2</sup>With UL 600 Volt enclosed switch and switchboard clearance spacings.

<sup>3</sup>Basic switch with UL 600 Volt industrial control spacings only.

<sup>4</sup>For 30 ampere switch with 600 Volt enclosed switch spacing and 60 ampere terminals, order Product Number THC31SSE, **List Price, \$242.00, GO-139.**

### Operating Shafts and TDM Handles

Component Type	Amperage Rating	Shaft Length	Shaft Operation	Nom. And Max. Inside Enclosure Depths (in.)	Enclosure Type	Product Number	List Price GO-144
Adjustable Operating Shafts	30A	Standard	Up-Down	5 1/16-7 15/16	-	THC1	\$5.70
Adjustable Operating Shafts	30A	Standard	Pendulum	5 1/16-7 15/16	-	THC1P	\$5.70
Adjustable Operating Shafts	30A	Long	Up-Down	11 1/8 (5 9/16)-14	-	THC1L	\$15.25
Adjustable Operating Shafts	60A	Long	Pendulum	11 1/8 (5 9/16)-14	-	THC1PL	\$15.25
Adjustable Operating Shafts	60A	Standard	Up-Down	5 13/16 (5 9/16)-9 1/4	-	THC2	\$7.80
Adjustable Operating Shafts	60A	Standard	Pendulum	5 13/16 (5 9/16)-9 1/4	-	THC2P	\$7.80
Adjustable Operating Shafts	100A	Standard	Up-Down	7 1/4 (6 7/16)-9 1/8	-	THC3	\$7.80
Adjustable Operating Shafts	100A	Standard	Pendulum	7 1/4 (6 7/16)-9 1/8	-	THC3P	\$7.80
Adjustable Operating Shafts	100A	Long	Up-Down	12 1/8 (6 7/16)-14	-	THC3L	\$15.25
Adjustable Operating Shafts	100A	Long	Pendulum	12 1/8 (6 7/16)-14	-	THC3PL	\$15.25
Adjustable Operating Shafts	200A	Standard	Up-Down	9 1/4-14 3/4	-	THC4	\$12.50
Adjustable Operating Shafts	200A	Standard	Pendulum	9 1/4-14 3/4	-	THC4P	\$12.50
Adjustable Operating Shafts	200A	Long	Up-Down	14 11/32 (9 1/4)-20	-	THC4L	\$23.25
Adjustable Operating Shafts	200A	Long	Pendulum	14 11/32 (9 1/4)-20	-	THC4PL	\$23.25
TDM Handles	30A 60A 100A	-	-	-	NEMA Type 1 NEMA Type 3R NEMA Type 12 NEMA Type 12K	THCH1	\$31.50
TDM Handles	200A	-	-	-	NEMA Type 1 NEMA Type 3R NEMA Type 12 NEMA Type 12K	THCH4	\$51.50
TDM Handles	-	-	-	-	NEMA Type 4/4X	THCH45 <sup>5</sup>	\$303.00

<sup>5</sup>Includes interlock for use only with 30-60 ampere HCI pendulum-operated shaft.



# Disconnect Switches and Operating Mechanisms General-Duty HCI (continued)

## Section 7

Individual Components

30-200 Amperes

240, 480, 600 Vac, 250 Vdc

### Fuse Clip and No Fuse Kits — Horsepower Ratings

#### For Basic Switches with 600 Volt Industrial Control and 250 Volt Enclosed Switch and Switchboard Clearance Spacings

Basic Switch Rating	HP Rating, AC, 3-Phase, NEC Standard @ 240Vac	HP Rating, AC, 3-Phase, NEC Standard @ 480Vac	HP Rating, AC, 3-Phase, NEC Standard @ 600Vac	HP Rating, AC, 3-Phase, Time-Delay Fuse @ 240Vac	HP Rating, AC, 3-Phase, Time-Delay Fuse @ 480Vac	HP Rating, AC, 3-Phase, Time-Delay Fuse @ 600Vac	HP Rating, 250Vdc	Product Number
30 Ampere 3-Pole	-	-	-	7.5	15	20	5	THC3100 <sup>1,3</sup>
30 Ampere 3-Pole	3	-	-	7.5	-	-	5	THC3121
30 Ampere 3-Pole	-	5	7.5	-	15	20	-	THC3161
30 Ampere 3-Pole	-	5	7.5	-	15	20	-	THC31J1
30 Ampere 3-Pole	7.5	-	-	-	-	-	-	THC3122
30 Ampere 3-Pole	-	15	15	-	-	-	-	THC3162
30 Ampere 3-Pole	-	15	15	-	-	-	-	THC31J2
60 Ampere 3-Pole	-	-	-	15	30	50	10	THC3200 <sup>2</sup>
60 Ampere 3-Pole	3	-	-	-	-	-	10	THC3221 <sup>2</sup>
60 Ampere 3-Pole	-	5	7.5	-	-	-	-	THC3261 <sup>2</sup>
60 Ampere 3-Pole	7.5	-	-	15	-	-	-	THC3222 <sup>2</sup>
60 Ampere 3-Pole	-	15	15	-	30	50	-	THC3262 <sup>2</sup>
60 Ampere 3-Pole	-	15	15	-	30	50	-	THC32J2 <sup>2</sup>
60 Ampere 3-Pole	15	-	-	-	-	-	-	THC3223 <sup>2</sup>
60 Ampere 3-Pole	-	25	30	-	-	-	-	THC3263 <sup>2</sup>
60 Ampere 3-Pole	-	25	30	-	-	-	-	THC32J3 <sup>2</sup>
100 Ampere 3-Pole	-	-	-	30	60	75	20	THC3300
100 Ampere 3-Pole	7.5	-	-	-	-	-	20	THC3322
100 Ampere 3-Pole	-	15	15	-	-	-	-	THC3362
100 Ampere 3-Pole	15	-	-	30	-	-	-	THC3323
100 Ampere 3-Pole	-	25	30	-	60	75	-	THC3363
100 Ampere 3-Pole	-	25	30	-	60	75	-	THC33J3
100 Ampere 3-Pole	25	-	-	-	-	-	-	THC3324
100 Ampere 3-Pole	-	50	60	-	-	-	-	THC3364
100 Ampere 3-Pole	-	50	60	-	-	-	-	THC33J4
200 Ampere 3-Pole	-	-	-	60	100	100	40	THC3400
200 Ampere 3-Pole	15	-	-	-	-	-	40	THC3423
200 Ampere 3-Pole	-	25	30	-	-	-	-	THC3463
200 Ampere 3-Pole	-	25	30	-	-	-	-	THC34J3
200 Ampere 3-Pole	25	-	-	60	-	-	-	THC3424
200 Ampere 3-Pole	-	50	60	-	100	100	-	THC3464
200 Ampere 3-Pole	-	50	60	-	100	100	-	THC34J4
200 Ampere 3-Pole	50	-	-	-	-	-	-	THC3425
200 Ampere 3-Pole	-	100	100	-	-	-	-	THC3465
200 Ampere 3-Pole	-	100	100	-	-	-	-	THC34J5

### Fuse and No-Fuse Kits — Horsepower Ratings

#### For Basic Switches with 600 Volt Enclosed Switch and Switchboard Clearance Spacings

Basic Switch Rating	HP Rating, AC, 3-Phase, NEC Standard @ 240Vac	HP Rating, AC, 3-Phase, NEC Standard @ 480Vac	HP Rating, AC, 3-Phase, NEC Standard @ 600Vac	HP Rating, AC, 3-Phase, Time-Delay Fuse @ 240Vac	HP Rating, AC, 3-Phase, Time-Delay Fuse @ 480Vac	HP Rating, AC, 3-Phase, Time-Delay Fuse @ 600Vac	HP Rating, 250Vdc	Product Number
30 Ampere 3-Pole	3	5	7.5	-	15	20	5	THC31S61 <sup>1,3</sup>
30 Ampere 3-Pole	3	5	7.5	-	15	20	5	THC31SJ1 <sup>1,3</sup>
30 Ampere 3-Pole	-	-	-	7.5	15	20	5	THC3100 <sup>1,3</sup>
60 Ampere 3-Pole	7.5	15	15	-	30	50	10	THC32S62
60 Ampere 3-Pole	7.5	15	15	-	30	50	10	THC32SJ2
60 Ampere 3-Pole	-	-	-	15	30	50	10	THC3200 <sup>2</sup>
100 Ampere 3-Pole	-	25	30	-	60	75	-	THC3363
100 Ampere 3-Pole	-	25	30	-	60	75	-	THC33J3
100 Ampere 3-Pole	-	-	-	30	60	75	20	THC3300
200 Ampere 3-Pole	-	50	60	-	100	100	-	THC3464
200 Ampere 3-Pole	-	50	60	-	100	100	-	THC34J4
200 Ampere 3-Pole	-	-	-	60	100	100	40	THC3400

Auxiliary switch (SPDT) for HCI rated .5 ampere at 125Vdc, .25 ampere at 250Vdc, 15 ampere at 480Vac. Product Number 343L296G2, **List Price \$102.00, GO-139.**

HCI switches, fuse and no-fuse kits, are listed in UL "Recognized Component Index" (WHTY2) for mounting in a vertical position, line side up. UL File E-36152.

Line shield included with THC31 and THC31S. All other line shields included with fuse-clip or no-fuse kits.

For **Two-pole applications**—Use two poles of three-pole switch.

HCI switches, fuse and no-fuse kits, are listed in UL "Recognized Component Index" (WHTY2) for mounting in a vertical position, line side up. UL File E-36152.

Inside enclosure depth may be reduced to these depths while maintaining electrical spacings—requires cutting handle shaft.

<sup>1</sup>Suitable for 25 hp @ 600 V but not UL listed.

<sup>2</sup>Basic switch with UL 600 Volt industrial control spacings only.

<sup>3</sup>For 30 ampere switch with 600 Volt enclosed switch spacing and 60 ampere terminals, order Product Number THC31SSE, **List Price, \$242.00, GO-139.**



# Disconnect Switches and Operating Mechanisms

## General-Duty HCI (continued)

## Section 7

Individual Components  
30-200 Amperes  
240, 480, 600 Vac, 250 Vdc

### Fuse Clip and No Fuse Kits

For Basic Switches with 600 Volt Industrial Control and 250 Volt Enclosed Switch and Switchboard Clearance Spacings.

Basic Switch Rating	Basic Switch Product Number	Fuse Type	Fuse Kit Rating	Product Number	List Price GO-139
30 Ampere 3-Pole	THC31S	No Fuse	No Fuse—600	THC3100 <sup>1,3</sup>	\$6.10
30 Ampere 3-Pole	THC31	NEC Standard	30A, 240Vac/250Vdc	THC3121	\$8.10
30 Ampere 3-Pole	THC31	NEC Standard	30A, 600Vac	THC3161	\$16.50
30 Ampere 3-Pole	THC31	Class J	30A, 600Vac	THC31J1	\$28.50
30 Ampere 3-Pole	THC31	NEC Standard	60A, 240Vac/250Vdc	THC3122	\$19.50
30 Ampere 3-Pole	THC31	NEC Standard	60A, 600Vac	THC3162	\$29.00
30 Ampere 3-Pole	THC31	Class J	60A, 600Vac	THC31J2	\$39.00
60 Ampere 3-Pole	THC32S	No Fuse	No Fuse—600	THC3200 <sup>2</sup>	\$8.10
60 Ampere 3-Pole	THC32	NEC Standard	30A, 240Vac/250Vdc	THC3221 <sup>2</sup>	\$29.50
60 Ampere 3-Pole	THC32	NEC Standard	30A, 600Vac	THC3261 <sup>2</sup>	\$33.00
60 Ampere 3-Pole	THC32	NEC Standard	60A, 240Vac/250Vdc	THC3222 <sup>2</sup>	\$13.00
60 Ampere 3-Pole	THC32	NEC Standard	60A, 600Vac	THC3262 <sup>2</sup>	\$22.75
60 Ampere 3-Pole	THC32	Class J	60A, 600Vac	THC32J2 <sup>2</sup>	\$33.00
60 Ampere 3-Pole	THC32	NEC Standard	100A, 240Vac/250Vdc	THC3223 <sup>2</sup>	\$92.00
60 Ampere 3-Pole	THC32	NEC Standard	100A, 600Vac	THC3263 <sup>2</sup>	\$104.00
60 Ampere 3-Pole	THC32	Class J	100A, 600Vac	THC32J3 <sup>2</sup>	\$133.00
100 Ampere 3-Pole	THC33S	No Fuse	No Fuse—600	THC3300	\$20.75
100 Ampere 3-Pole	THC33	NEC Standard	60A, 240Vac/250Vdc	THC3322	\$51.00
100 Ampere 3-Pole	THC33	NEC Standard	60A, 600Vac	THC3362	\$56.00
100 Ampere 3-Pole	THC33	NEC Standard	100A, 240Vac/250Vdc	THC3323	\$99.50
100 Ampere 3-Pole	THC33S	NEC Standard	100A, 600Vac	THC3363	\$116.00
100 Ampere 3-Pole	THC33S	Class J	100A, 600Vac	THC33J3	\$72.00
100 Ampere 3-Pole	THC33	NEC Standard	200A, 240Vac/250Vdc	THC3324	\$200.00
100 Ampere 3-Pole	THC33	NEC Standard	200A, 600Vac	THC3364	\$250.00
100 Ampere 3-Pole	THC33	Class J	200A, 600Vac	THC33J4	\$244.00
200 Ampere 3-Pole	THC34S	No Fuse	No Fuse—600	THC3400	\$40.50
200 Ampere 3-Pole	THC34	NEC Standard	100A, 240Vac/250Vdc	THC3423	\$99.50
200 Ampere 3-Pole	THC34	NEC Standard	100A, 600Vac	THC3463	\$113.00
200 Ampere 3-Pole	THC34	Class J	100A, 600Vac	THC34J3	\$134.00
200 Ampere 3-Pole	THC34	NEC Standard	200A, 240Vac/250Vdc	THC3424	\$64.50
200 Ampere 3-Pole	THC34	NEC Standard	200A, 600Vac	THC3464	\$108.00
200 Ampere 3-Pole	THC34	Class J	200A, 600Vac	THC34J4	\$143.00
200 Ampere 3-Pole	THC34	NEC Standard	400A, 240Vac/250Vdc	THC3425	\$471.00
200 Ampere 3-Pole	THC34	NEC Standard	400A, 600Vac	THC3465	\$549.00
200 Ampere 3-Pole	THC34	Class J	400A, 600Vac	THC34J5	\$613.00

### Fuse Clip and No Fuse Kits

For Basic Switches with 600 Volt Enclosed Switch and Switchboard Clearance Spacings.

Basic Switch Rating	Basic Switch Product Number	Fuse Type	Fuse Kit Rating	Product Number	List Price GO-139
30 Ampere 3-Pole	THC31S	NEC Standard	30A, 600Vac	THC31S61 <sup>1,3</sup>	\$16.50
30 Ampere 3-Pole	THC31S	Class J	30A, 600Vac	THC31SJ1 <sup>1,3</sup>	\$32.50
30 Ampere 3-Pole	THC31S	No Fuse	No Fuse—600	THC3100 <sup>1,3</sup>	\$6.10
60 Ampere 3-Pole	THC32S	NEC Standard	60A, 600Vac	THC32S62	\$35.50
60 Ampere 3-Pole	THC32S	Class J	60A, 600Vac	THC32SJ2	\$42.00
60 Ampere 3-Pole	THC32S	No Fuse	No Fuse—600	THC3200 <sup>2</sup>	\$8.10
100 Ampere 3-Pole	THC33S	NEC Standard	100A, 600Vac	THC3363	\$116.00
100 Ampere 3-Pole	THC33S	Class J	100A, 600Vac	THC33J3	\$72.00
100 Ampere 3-Pole	THC33S	No Fuse	No Fuse—600	THC3300	\$20.75
200 Ampere 3-Pole	THC34	NEC Standard	200A, 600Vac	THC3464	\$108.00
200 Ampere 3-Pole	THC34	Class J	200A, 600Vac	THC34J4	\$143.00
200 Ampere 3-Pole	THC34S	No Fuse	No Fuse—600	THC3400	\$40.50

Auxiliary switch (SPDT) for HCI rated .5 ampere at 125Vdc, .25 ampere at 250Vdc, 15 ampere at 480Vac. Product Number 343L296G2, List Price \$102.00, GO-139.

HCI switches, fuse and no-fuse kits, are listed in UL "Recognized Component Index" (WHTY2) for mounting in a vertical position, line side up. UL File E-36152.

Line shield included with THC31 and THC31S. All other line shields included with fuse-clip or no-fuse kits.

For **Two-pole applications**—Use two poles of three-pole switch.

HCI switches, fuse and no-fuse kits, are listed in UL "Recognized Component Index" (WHTY2) for mounting in a vertical position, line side up. UL File E-36152.

Inside enclosure depth may be reduced to these depths while maintaining electrical spacings—requires cutting handle shaft.

<sup>1</sup>Suitable for 25 hp @ 600 V but not UL listed.

<sup>2</sup>Basic switch with UL 600 Volt industrial control spacings only.

<sup>3</sup>For 30 ampere switch with 600 Volt enclosed switch spacing and 60 ampere terminals, order Product Number THC31SSE, List Price, \$242.00, GO-139.



## TDR Handle Mechanism

### Handle Operating Mechanisms

#### TDR Integral Handle Mechanism for QMR/QMW Disconnects

- Rotary operating handle mounts directly to disconnect.
- Operates through enclosure door—mechanical interlock designed to prevent unauthorized opening of enclosure when disconnect is ON.
- Locking hasp accommodates up to three padlocks.
- Suitable for use with NEMA 1, 12, and 12K enclosures.
- UL Recognized Components, File E-36152.



TDR Handle

#### Integral Handles (Separate Kits for Field Assembly)

Accessory Type	Ampere Rating	Add to Switch Product No. Suffix for Factory Assembly	Product Number	List Price GO-144
Integral Handle, Vertical	30A, 60A, 100A	V1	THMR1B	\$70.00
Integral Handle, Vertical	200A	V2	THMR2B	\$82.50
Integral Handle, Horizontal	30A, 60A, 100A	H1	THMR1HB	\$70.00
Integral Handle, Horizontal	200A	H1	THMR2HB	\$82.50
Door ring interlock	-	-	SEFRDRCK	\$11.25
Gasket kit	-	-	SEFRGSK	\$4.00

#### Auxiliary Switches (Separate Kits for Field Assembly)

Accessory Type	Ampere Rating	Add to Integral Handle Product No. Suffix for Factory Installation	Product Number	List Price GO-139
Auxiliary Switch	100	AS1	343L492G1	\$99.50
Auxiliary Switch	200	AS2	343L492G2	\$99.50



# Disconnect Switches and Operating Mechanisms

## HPC High-Pressure Contact Switch

Top- or Bottom Feed  
800-4000 Amperes - 600 Vac Max.

### Product Introduction

GE type HPC switches are UL listed in accordance with Standard 977, Fused Power Circuit Devices (UL File No. E-51827). The over-center toggle mechanism provides stored energy, quick-make/quick-break operation. Multiple spring-loaded high-pressure current-carrying contact arms and an arcing contact arm provide excellent current-carrying capability without sacrificing high interrupting fault performance. These switches are 100 percent rated and can interrupt, on a make and break basis, a minimum of 12 times their nameplate rating without fuse assistance at 600Vac. Complete HPC switch and Class L fuse coordination is therefore achieved for all levels of fault current up to 200,000 rms amperes symmetrical at 600Vac maximum. Type HPC switches used as service disconnects comply with the National Electrical Code Article 110.10 for adequate short-circuit current and ground fault protection.

### Features

- High Durability—Safety of Operation**  
High-dielectric strength, glass reinforced insulating case.
- High Interrupting Capability**  
Arc chute of unique construction suppresses arcs and cools gases rapidly, providing quick arc interruption and extended switch life.
- High Transient Voltage Withstandability**  
Interphase partitions mesh with switch cover to completely isolate each pole.
- Extended Switch Life**  
Preloaded constant pressure pivot eliminates braid whip and fraying on high short circuit currents and repeated operations.
- Positive “ON-OFF” Indication**  
Green (OFF), Red (ON), provides visual indication regarding the position of the switch contacts.
- Easy Operation—Quick Make**  
Extra heavy-duty, low torque rotary operated closing mechanism. L-handle 800-1600A. T-handle 2000-4000A.
- Emergency Open—Quick Break**  
Finger-tip “OFF” button rapidly opens the switch contacts.
- Positive Door and Switch Interlocking**  
Separate fuse access door is not required.
- Fuse Mounting Bolts with Captive Washers for Ease of Mounting Fuses**
- Padlocking Provisions Standard**

### Product Forms

- Top Feed**—Line terminals at top of switch.
- Bottom Feed**—Line terminals at bottom of switch; fuses are de-energized when switch is in OFF positions. Same size as top-feed.



800A-1600A HPC Switch



Manual 2000A-4000A HPC Switch (Bottom-Feed Shown)

### Product Options

- Manual Operation**—For manual, high-interrupting capacity disconnects not requiring remote tripping and/or ground fault protection.
- Integral Ground Fault**—Incorporates a solid-state, inverse-time and fixed time response. Ground fault function is self-powered and has field adjustable ground fault current and delay time settings for maximum coordination and selectivity. Through 3000 amperes, switches with integral ground fault are the same size as manual switches; 4000 amperes is 2 inches longer and 3 inches wider.
- Ground Fault Alarm**—only is available as an option.
- Electric Trip (Shunt Trip)**—For remote tripping or for use with Ground Break® components. All 800-4000 ampere electric trip switches are the same size as manual devices.



# Disconnect Switches and Operating Mechanisms

## Section 7

### HPC High-Pressure Contact Switch

Top- or Bottom-Feed

800-4000 Amperes - 600 Vac Max.

#### HPC Switches with Electric Trip

For use with Ground Break<sup>®</sup> components or for remote tripping. Fuses not included.

For resistance-grounded systems or where zone selective interlocking is required, electric trip HPC switches with Ground Break<sup>®</sup> system components are recommended.

Source Configuration	Ampere Rating	Control Voltage	Net Weight, Lbs. (Approx.)	Product Number	List Price GO-149
Top Feed	800A	120-240Vac	75	THPR3608ET1	\$10004.00
Top Feed	1200A	120-240Vac	80	THPR3612ET1	\$10672.00
Top Feed	1600A	120-240Vac	80	THPR3616ET1	\$11228.00
Top Feed	2000A	120-240Vac	165	THPC3620ET1	\$11891.00
Top Feed	2500A	120-240Vac	180	THPC3625ET1	\$13114.00
Top Feed	3000A	120-240Vac	180	THPC3630ET1	\$19669.00
Top Feed	4000A	120-240Vac	505	THPC3640ET1	\$24600.00
Top Feed	800A	480-600Vac	75	THPR3608ET2	\$10004.00
Top Feed	1200A	480-600Vac	80	THPR3612ET2	\$10672.00
Top Feed	1600A	480-600Vac	80	THPR3616ET2	\$11228.00
Top Feed	2000A	480-600Vac	165	THPC3620ET2	\$11891.00
Top Feed	2500A	480-600Vac	180	THPC3625ET2	\$13114.00
Top Feed	3000A	480-600Vac	180	THPC3630ET2	\$19669.00
Top Feed	4000A	480-600Vac	505	THPC3640ET2	\$24600.00
Bottom Feed	800A	120-240Vac	75	THPR3608BET1	\$10004.00
Bottom Feed	1200A	120-240Vac	80	THPR3612BET1	\$10672.00
Bottom Feed	1600A	120-240Vac	80	THPR3616BET1	\$11228.00
Bottom Feed	2000A	120-240Vac	165	THPC3620BET1	\$11891.00
Bottom Feed	2500A	120-240Vac	180	THPC3625BET1	\$13114.00
Bottom Feed	3000A	120-240Vac	180	THPC3630BET1	\$19669.00
Bottom Feed	4000A	120-240Vac	505	THPC3640BET1	\$24600.00
Bottom Feed	800A	480-600Vac	75	THPR3608BET2	\$10004.00
Bottom Feed	1200A	480-600Vac	80	THPR3612BET2	\$10672.00
Bottom Feed	1600A	480-600Vac	80	THPR3616BET2	\$11228.00
Bottom Feed	2000A	480-600Vac	165	THPC3620BET2	\$11891.00
Bottom Feed	2500A	480-600Vac	180	THPC3625BET2	\$13114.00
Bottom Feed	3000A	480-600Vac	180	THPC3630BET2	\$19669.00
Bottom Feed	4000A	480-600Vac	505	THPC3640BET2	\$24600.00

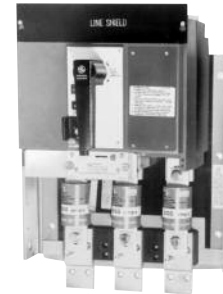

Type THPR, 800-1600A HPC Switch, Top Feed

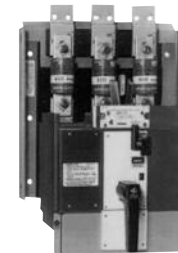

Type THPR, 800-1600A HPC Switch, Bottom Feed

#### Manual HPC Switches

For service or feeder disconnects not requiring ground fault protection. Includes fuse-mounting hardware and door-catch interlock bracket. Fuses not included.

Source Configuration	Ampere Rating	Net Weight Lbs. (Approx.)	Product Number	List Price GO-149
Top Feed	800A	75	THPR3608	\$5889.00
Top Feed	1200A	80	THPR3612	\$6443.00
Top Feed	1600A	80	THPR3616	\$7002.00
Top Feed	2000A	165	THPC3620	\$7441.00
Top Feed	2500A	180	THPC3625	\$8777.00
Top Feed	3000A	180	THPC3630	\$14999.00
Top Feed	4000A	505	THPC3640	\$17893.00
Bottom Feed	800A	75	THPR3608B	\$5889.00
Bottom Feed	1200A	80	THPR3612B	\$6443.00
Bottom Feed	1600A	80	THPR3616B	\$7002.00
Bottom Feed	2000A	165	THPC3620B	\$7441.00
Bottom Feed	2500A	180	THPC3625B	\$8777.00
Bottom Feed	3000A	180	THPC3630B	\$14999.00
Bottom Feed	4000A	505	THPC3640B	\$17893.00





# Disconnect Switches and Operating Mechanisms

## HPC High-Pressure Contact Switch

With Integral Ground Fault Devices  
 800-4000 Amperes - 600 Vac Max.  
 UL File. No. E-51827

### HPC Switches with Integral Ground Fault Protection for Solidly Grounded Systems

Integral Ground Fault with 3-Phase Sensor, Adjustable Pick-up, Adjustable Time-Delay, Test Function, and Mechanical Ground Fault Indicator

Source Configuration	Ampere Rating	Net Weight Lbs. (Approx.)	Product Number	List Price GO-149
Top Feed	800A	105	THPR3608G3T	\$16502.00
Top Feed	1200A	105	THPR3612G3T	\$16807.00
Top Feed	1600A	105	THPR3616G3T	\$17384.00
Top Feed	2000A	195	THPC3620G3T	\$18754.00
Top Feed	2500A	210	THPC3625G3T	\$20547.00
Top Feed	3000A	210	THPC3630G3T	\$23867.00
Top Feed	4000A	540	THPC3640G3T	\$34219.00
Bottom Feed	800A	105	THPR3608BG3T	\$16502.00
Bottom Feed	1200A	105	THPR3612BG3T	\$16807.00
Bottom Feed	1600A	105	THPR3616BG3T	\$17384.00
Bottom Feed	2000A	195	THPC3620BG3T	\$18754.00
Bottom Feed	2500A	210	THPC3625BG3T	\$20547.00
Bottom Feed	3000A	210	THPC3630BG3T	\$23867.00
Bottom Feed	4000A	540	THPC3640BG3T	\$34219.00



HPC Switches with Integral Ground Fault Protection

### HPC Switches with Integral Ground Fault Alarm only for Solidly Grounded Systems

Integral Ground Fault with 3-Phase Sensor, Adjustable Pick-up, Adjustable Time-Delay, Test Function, and Mechanical Ground Fault Indicator

Source Configuration	Ampere Rating	Net Weight Lbs. (Approx.)	Product Number	List Price GO-149
Top Feed	800A	105	THPR3608GA3	\$16502.00
Top Feed	1200A	105	THPR3612GA3	\$16807.00
Top Feed	1600A	105	THPR3616GA3	\$17384.00
Top Feed	2000A	195	THPC3620GA3	\$18754.00
Top Feed	2500A	210	THPC3625GA3	\$20547.00
Top Feed	3000A	210	THPC3630GA3	\$23867.00
Top Feed	4000A	540	THPC3640GA3	\$34219.00
Bottom Feed	800A	105	THPR3608BGA3	\$16502.00
Bottom Feed	1200A	105	THPR3612BGA3	\$16807.00
Bottom Feed	1600A	105	THPR3616BGA3	\$17384.00
Bottom Feed	2000A	195	THPC3620BGA3	\$18754.00
Bottom Feed	2500A	210	THPC3625BGA3	\$20547.00
Bottom Feed	3000A	210	THPC3630BGA3	\$23867.00
Bottom Feed	4000A	540	THPC3640BGA3	\$34219.00

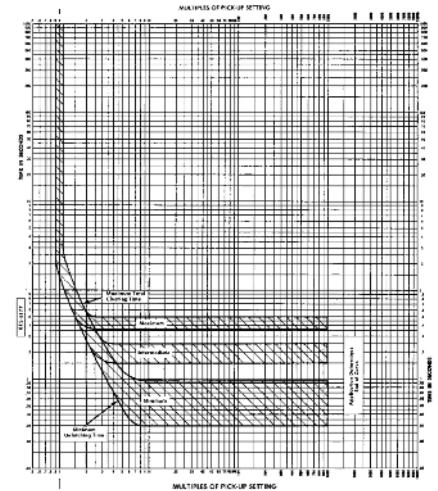

Integral Ground Fault HPC Pick-up and Delay Time-current Curves

Includes fuse-mounting hardware and door-catch interlock bracket. (Fuses not included)

**NOTE:** The 800-3000 ampere integral ground fault HPC switches can easily be installed in the space occupied by a manual HPC switch of the same ampere rating. The 4000 ampere switch, being 3 inches wider, may require some modification.

**NOTE:** Integral ground fault tripping is accomplished by a low-energy, flux-shifting tripping mechanism and is not suitable for remote (paralleled) tripping. If remote tripping is required, add suffix RT1 120-240Vac or RT2 480-600Vac to above product number. **List Price adder, \$479.00, GO-149.**

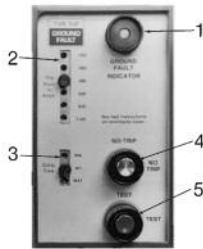

- Mechanical Indicator** – protrudes when ground fault occurs.
- Field Adjustable Ground Fault Trip Point** – from 200 to 1100 amperes in six steps.
- Field Adjustable Ground Fault Delay Time** – min. (0.03 sec.) intermediate (0.20 sec.) and max. (0.50 sec.) delay time settings.
- No Trip Test Button** – permits ground fault system check without tripping switch.
- Test Button** – simulates an actual ground fault and will trip switch off unless "No Trip" button is depressed prior to pushing test button. Ground fault indicator will protrude when system is tested or when actual ground fault occurs.

**Note:** Although the integral ground fault function is self-powered, the test function does require an external 120Vac (200 volt amperes nominal) control power source.



## HPC High-Pressure Contact Switch (continued)

With Integral Ground Fault Devices

800-4000 Amperes

600 Vac Max.

UL File. No. E-51827

### Neutral Current (800: 1 ratio) Sensors

Inside Dimensions	Core Construction	Thermal Rating (Amperes)	Weight (Lbs.)	Product Number	List Price GO-142
2.5" Dia.	Solid	1600	3	TGS0002	<b>\$460.00</b>
5" Dia.	Solid	2500	4	TGS0005	<b>\$731.00</b>
8" Dia.	Solid	3000	7	TGS0008	<b>\$856.00</b>
4" x 8"	Split	4000	15	TGS0408	<b>\$1439.00</b>
8" x 8"	Split	4000	25	TGS0808	<b>\$1482.00</b>



Neutral Current Sensor - Solid



Neutral Current Sensor - Split

Accessories  
UL Listed

### Factory Installed Auxiliary Switches

Auxiliary Switch Factory Installed Only. Mounts internally. Provides remote indication of main contact position. Switch elements are Type "AB", single-pole, double-throw. Leads are connected to externally mounted terminals. Order one terminal block THPCB1 for one or two switches; order two THPCB1 for three or four switches. Specify and price switches and terminal blocks separately.

Switch element ratings:  
—1/4 ampere at 250Vdc —1/2 ampere at 125Vdc  
—6 amperes at 240Vac.

Basic Switch Rating (Amperes)	Number of Switch Elements	Product Number	List Price GO-145A
800-1600	1	TPAS2AB1L	\$251.00
800-1600	2	TPAS2AB2L	\$503.00
800-1600	3	TPAS2AB3L	\$534.00
800-1600	4	TPAS2AB4L	\$562.00
2000-4000	1	TSAS2AB1R	\$251.00
2000-4000	2	TSAS2AB2R	\$503.00
2000-4000	3	TSAS2AB3R	\$534.00
2000-4000	4	TSAS2AB4R	\$562.00

### Factory Installed Auxiliary Switch Terminal Block

Product Number	List Price GO-149
THPCB1	\$102.00

### Factory Installed Provision for Customer Installation of Kirk Key Interlock

Provision only - customer to supply and install lock. Order from ITE Kirk catalog - Type F removable with bolt extended, bolt flush when withdrawn.

Basic Switch Rating (Amperes)	Number of Padlocks	Product Number	List Price GO-145A
800, 1200, 1600	1	TPK01	\$817.00
800, 1200, 1600	1	TPK01B <sup>1</sup>	\$817.00
800, 1200, 1600	2	TPK02	\$817.00
800, 1200, 1600	3	TPK03	\$817.00
2000, 2500, 3000, 4000	1, 2, 3	THPCGL	\$1772.00 <sup>2</sup>

<sup>1</sup>For bottom-feed 800-1600 ampere switches only.

<sup>2</sup>GO-149

### Factory Installed Blown Fuse Protector

Provides single-phase protection by tripping switch when a fuse blows or when switch is closed with a blown fuse or no fuse installed. Suitable for system voltage of 208 to 480Vac. Mounted internally. Does not provide protection from single-phasing of the power source.

Basic Switch Rating (Amperes)	Product Number	List Price GO-149
800-1600	THPRFP	\$2131.00
2000-3000	THPCFP	\$2131.00
4000	THPCFPA	\$2131.00

### Adapter Kits

(Accepts either lugs, bus, or Anderson VCEL VersaCrimp)

For Line or Load end of 3-pole switch.

Ampere Rating	Product Number	List Price GO-145A
800A	THPCLUGA08	\$157.00
1200A	TPLUGA16 <sup>3</sup>	\$389.00

<sup>3</sup>GO-245B

### Field Installed Lugs Kits 800-1600 Ampere Switches-Direct Mounting

Field installed only. Kits consist of lugs and hardware for direct mounting to switch terminal straps (multiple-hole tang lugs) or lugs for mounting to 800 ampere terminal adapter kit. Order three kits for three-pole line or load end. For 1600-ampere, copper conductors must be used.

Ampere Rating	Accessory Type	Wire Range Cu/Al	Product Number	List Price GO-145A
800A	Lug Kit Line & Lug Kit Load	(3) 300-750	THPCLUG308	\$63.50
1200A, 1600A	Lug Kit Line	(4) 500-800 kcmil	TPLUG408	\$39.00 <sup>4</sup>
1200A, 1600A	Lug Kit Load	(4) 500-800 kcmil	THPCLUG408	\$77.50

<sup>4</sup>GO-245B

### Field Installed Lugs Kits 2000-4000 Ampere Switches-Direct Mounting

Field installed only. To terminate line and load cables, must be used in conjunction with bus-connection adapter on page 7-20 (T Studs). Each lug kit includes lugs, straps and hardware for three-phase line or load connections. Each cable lug accommodates 1-3/0 Cu or 250 kcmil Al to 800 kcmil Cu-Al. Accepts Anderson VersaCrimp when lugs are removed from straps.

Ampere Rating	No. of Lugs per Pole Line or Load End	Product Number	List Price GO-245B
2000A	6	TSLUG20	\$383.00
2500A	7	TSLUG25	\$418.00
3000A	9	TSLUG30	\$630.00
4000A	11	TSLUG40	\$1045.00

### Field Installed T Studs

Field installed only. May be used to adapt line and load terminals of switch to vertical or horizontal bus arrangements. Three required for line or load connections on three-phase bus. Accepts either lugs, bolts, or Anderson VCEL VersaCrimp.

Basic Switch Rating (Amperes)	Product Number	List Price GO-145A
800	THPC08FCA <sup>5</sup>	\$71.00
1200-1600	TP16FCA	\$113.00
2000	TS20FCA	\$113.00
2500	TS25FCA	\$119.00
3000	TS30FCA	\$418.00
4000	(5)TS40FCA	\$562.00
4000	(1)TS40LFCA <sup>6</sup>	\$789.00

<sup>5</sup>For vertical bussing only.

<sup>6</sup>For center pole, line terminal.

### Lug Kits (For use with adapter only)

(Accepts either lugs, bus, or Anderson VCEL VersaCrimp)

One per Product Number; standard carton contains:

6—TPLUG106;

3—TPLUG108.

Ampere Rating	No. of Lugs per Pole Line or Load End	Wire Range Cu/Al	Product Number	List Price GO-245B
800A	3	(1) #2-600 kcmil or (2) 1/0-250 kcmil	TPLUG106	\$18.50
800A	3	(1) 3/0-800 kcmil Cu or (1) 250-800 kcmil Al	TPLUG108	\$23.00



# Disconnect Switches and Operating Mechanisms

# Section 7

## HPC High-Pressure Contact Switch

### Application Information Outlines and Dimensions

#### Application Information – HPC Switches with Integral Ground Fault Protection

Weights are for units with integrally mounted three-phase sensor.

Ampere Rating	Outline Drawing	Approx. Shipping Weight (Lbs.)	Approx. Net Weight (Lbs.)	Connectors Product Number
800A	139C4219	115	105	1
2000A	139C4114 sh 2	220	195	TS20FCA (Optional)
2500A	139C4114 sh 3	235	210	TS25FCA (Optional)
3000A	139C4114 sh 3	235	210	TS30FCA (Optional)
4000A	139C4114 sh 6	464	540	1-TS40LFCA 5-TS40FCA

#### Application Information – HPC Switches without Integral Ground Fault Protection

Data in the table below pertains to Type HPC switches without integral ground devices.

Ampere Rating	Outline Drawing	Approx. Shipping Weight (Lbs.)	Approx. Net Weight (Lbs.)	Connectors Product Number
800A	139C4219	85	75	1
2000A	139C4114 sh 2	190	165	TS20FCA (Optional)
2500A	139C4114 sh 3	205	180	TS25FCA (Optional)
3000A	139C4114 sh 3	205	180	TS30FCA (Optional)
4000A	139C4114 sh 6	429	505	1-TS40LFCA 5-TS40FCA

#### Minimum OEM Enclosure Dimensions and Ventilation Requirements<sup>2</sup>

Ampere Rating	Min Volume (Cubic Inches)	A Min Ventilation <sup>3</sup> Top and Bottom (Square Inches)	B Min Line to Ground (Inches)	C Min Height (Inches)	D Min Width (Inches)	E Mounting <sup>4</sup> Depth (Inches)	F Min to Ground or Insulation (Inches)
800A	8400	23	2	28	25	8.66	3.5
1200A-1600A	11100	63	2	30	25	8.66	3.5
2000A	28000	63	2	40	25	9.38	3
2500A	28000	172	2	40	25	9.38	3
3000A	30000	172	2	40	25	9.38	3
4000A	54650	189	9	52	30	11.12	3

#### Switch Dimensions (For Estimating Only)<sup>5</sup>

Ampere Rating <sup>6</sup>	Dimension A	Dimension B	Dimension C	Dimension D	Dimension E	Dimension F
800	24.31	18.00	8.66	7.69	-	4.96
1200, 1600	26.72	18.00	8.66	7.69	-	4.96
2000, 2500, 3000	36.00	19.25	9.38	8.25	-	15.56
4000	40.00	22.38 <sup>7</sup>	11.12	9.24	12.75 (Bø) 7.75 (Aø & Cø)	18.19

Note: For dimensions of neutral current sensor to be used with integral ground fault switches, page 7-18.

<sup>1</sup>See page 7-19 for optional connectors.

<sup>2</sup>Dimensions are minimum requirements and do not represent enclosures on page 7-20.

<sup>3</sup>Ventilating openings can be in alternate locations but must provide equivalent ventilating areas.

<sup>4</sup>For switches with integrally mounted three-phase Ground Fault current sensor (Product Numbers with suffix G3T, G3R, GA3, BG3T, BGA3, BG3R) add 1.62 inch to dimension "E".

<sup>5</sup>For complete switch dimensions order outline drawings from application information above.

<sup>6</sup>For Product Numbers with suffix "B" (bottom-feed), invert drawing.

<sup>7</sup>With integral ground fault, overall width is 24 inches.

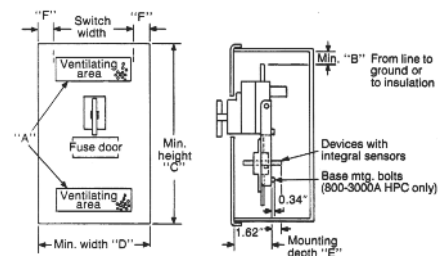

Minimum OEM Enclosure Dimensions and Ventilation Requirements

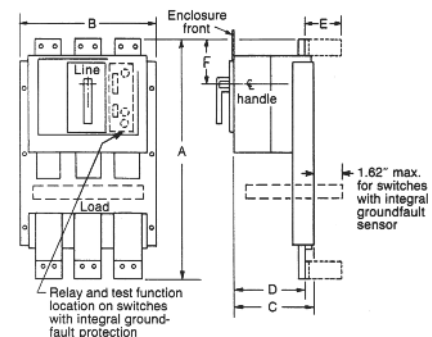

Switch Dimensions (For Estimating Only)



# Disconnect Switches and Operating Mechanisms FD1 Fusible IEC Style

## Section 7

Individual Components

600 Vac

250 Vdc



FD130CC

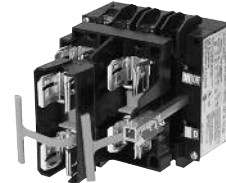

FD130J



FD130NF



FD160J



FD160NF

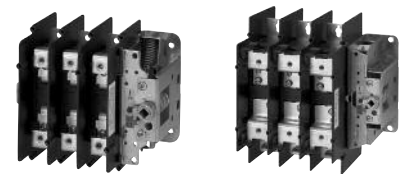

FD1100J and FD1200J

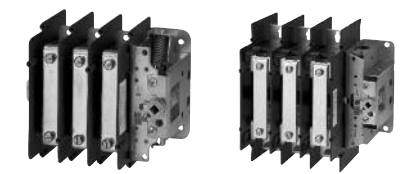

FD1100NF and FD1200NF

### Horsepower Ratings (Time Delay)

#### Fuse Operating Characteristics

Product Number	Maximum HP, 3-Phase AC @ 240Vac, 60Hz, Time Delay	Maximum HP, 3-Phase AC @ 480Vac, 60Hz, Time Delay	Maximum HP, 3-Phase AC @ 600Vac, 60Hz, Time Delay	Maximum HP, Single-Phase AC @ 120Vac, 60Hz, Time Delay	Maximum HP, Single-Phase AC @ 240Vac, 60Hz, Time Delay	Maximum HP, DC @ 125Vdc, Time Delay	Maximum HP, DC @ 250Vdc, Time Delay
FD130CC	5	10	10	0.75	2	2	3
FD130J	7.5	15	20	2	3	3	5
FD130NF	7.5	15	20	2	3	3	5
FD160J	15	30	50	3	10	5	10
FD160NF	15	30	50	3	10	5	10
FD1100J	30	60	75	-	15	-	20
FD1100NF	30	60	75	-	15	-	20
FD1200J	60	125	150	-	25	-	40
FD1200NF	60	125	150	-	25	-	40

### Horsepower Ratings (Non-Time Delay)

#### Fuse Operating Characteristics

Product Number	Maximum HP, 3-Phase AC @ 240Vac, 60Hz, Non-Time Delay	Maximum HP, 3-Phase AC @ 480Vac, 60Hz, Non-Time Delay	Maximum HP, 3-Phase AC @ 600Vac, 60Hz, Non-Time Delay	Maximum HP, Single-Phase AC @ 120Vac, 60Hz, Non-Time Delay	Maximum HP, Single-Phase AC @ 240Vac, 60Hz, Non-Time Delay	Maximum HP, DC @ 125Vdc, Non-Time Delay	Maximum HP, DC @ 250Vdc, Non-Time Delay
FD130CC	5	10	10	0.75	2	2	3
FD130J	3	5	7.5	0.5	1.5	2	5
FD130NF	3	5	7.5	0.5	1.5	2	5
FD160J	7.5	15	15	1.5	3	5	5
FD160NF	7.5	15	15	1.5	3	5	5
FD1100J	15	25	30	-	7.5	-	20
FD1100NF	15	25	30	-	7.5	-	20
FD1200J	25	50	60	-	15	-	40
FD1200NF	25	50	60	-	15	-	40

### IEC Disconnects — Fuse Specification

Ampere Rating	Fuse Type	Maximum Fuse Cartridge Size	Maximum Voltage	Maximum Available Fault Current	Product Number	List Price GO-139V
30A	Class CC HRCI-MISC	30 A	600Vac/250Vac	100 kA	FD130CC <sup>2</sup>	\$133.00
30A	Class J HRCI-J	30 A	600Vac/250Vac	100 kA	FD130J	\$145.00
30A	Non-Fused	30 A	600Vac/250Vac	100 kA	FD130NF <sup>1,2</sup>	\$122.00
60A	Class J HRCI-J	60 A	600Vac/250Vac	100 kA	FD160J	\$188.00
60A	Non-Fused	60 A	600Vac/250Vac	100 kA	FD160NF <sup>1,2</sup>	\$147.00
100A	Class J HRCI-J	100	600Vac/250Vac	100 kA	FD1100J	\$480.00
100A	Non-Fused	Non-Fused	600Vac/250Vac	100 kA	FD1100NF <sup>1,2</sup>	\$490.00
200A	Class J HRCI-J	200	600Vac/250Vac	100 kA	FD1200J	\$1100.00
200A	Non-Fused	Non-Fused	600Vac/250Vac	100 kA	FD1200NF <sup>1,2</sup>	\$1142.00

<sup>1</sup>Non-fused disconnect switches must be used with separately installed UL Listed class J, CC or T fuses; or CSA Certified HRCI-J, HRCI-T or HRCI-MISC.

<sup>2</sup>CSA HRCI-MISC fuses must also be UL Listed as class CC fuses.

### Mechanical Specifications<sup>3</sup>

Product Number	Mechanical Endurance Operations	Normal Operating Torque	Terminal Capacity / Power Terminals	Terminal Capacity / Auxiliary Switch Terminals	Maximum Number of Auxiliary Circuits
FD130CC	10000	27	#14 - #8	#14 - #12	4
FD130J	10000	27	#14 - #8	#14 - #12	4
FD130NF	10000	27	#14 - #8	#14 - #12	4
FD160J	10000	45	#14 - #4	#14 - #12	4
FD160NF <sup>1</sup>	10000	45	#14 - #4	#14 - #12	4
FD1100J	10000	107	#14 - #2	#14 - #12	4
FD1100NF	10000	107	#14 - #2	#14 - #12	4
FD1200J	10000	239	#6 - 250kcmil	#14 - #12	4
FD1200NF	10000	239	#6 - 250kcmil	#14 - #12	4

<sup>3</sup>See page 7-25 for additional Mechanical Specifications.



# Disconnect Switches and Operating Mechanisms

## FD1 Fusible IEC Style

## Section 7

### Accessories

#### Door Mounted Rotary Operating Handles NEMA Type 1/12/4/4X (IP65)

Switch Type	Color	Comments	Product Number	List Price GO-139V
FD130 or FD160	Black	NEMA 4, 4X, with defeat to enable panel entry while power on.	FD1HA4XB	\$35.00
FD130 or FD160	Red/Yellow	NEMA 4, 4X, with defeat to enable panel entry while power on.	FD1HA4XRY	\$35.00
FD1100 or FD1200	Black	NEMA 3R, simple on/off pistol grip handle	FD11HA1B	\$66.00
FD1100 or FD1200	Red/Yellow	NEMA 3R, simple on/off pistol grip handle	FD11HA1RY	\$66.00
FD1100 or FD1200	Black	NEMA 3R, on/off with lock-out tag-out pistol grip handle	FD11HA4B	\$107.00
FD1100 or FD1200	Red/Yellow	NEMA 3R, on/off with lock-out tag-out pistol grip handle	FD11HA4RY	\$107.00
FD1100 or FD1200	Black	NEMA 3R, on/off with lock-out tag-out and defeatable pistol grip handle	FD11HA3B	\$125.00
FD1100 or FD1200	Red/Yellow	NEMA 3R, on/off with lock-out tag-out and defeatable pistol grip handle	FD11HA3RY	\$125.00

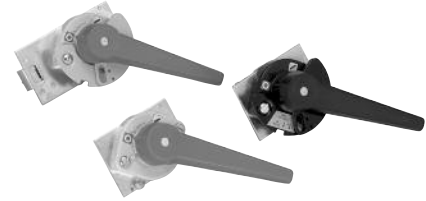

Pistol Grip Operating Handle



Rotary Operating Handle

#### Operating Shafts

Switch Type	Handle Type	Enclosure Depth (Max.)	Shaft Length	Product Number	List Price GO-139V
FD130 or FD160	FD1HA4X	10 15/64 (260)	166mm or 6 17/32in.	FD1S166	\$11.00
FD130 or FD160	FD1HA4X	17 7/8 (454)	360mm or 14 11/64in.	FD1S360	\$14.00
FD1100 or FD1200	FD11HA	11 21/38 (296)	200mm or 7 7/8in.	FD1S12	\$20.00
FD1100 or FD1200	FD11HA	16 15/64 (430)	319mm or 12 19/32in.	FD1L12	\$96.00



Operating Shafts

#### Auxiliary Switches

Switch Type	Description	Contact Configuration	Location	Product Number	List Price GO-139V
FD130, FD160, FD1100 or FD1200	SPDT	NO	First	FD1ASNO1	\$32.00
FD130, FD160, FD1100 or FD1200	SPDT	NC	First	FD1ASNC1	\$32.00
FD130, FD160, FD1100 or FD1200	SPDT	NO	Second	FD1ASNO2	\$32.00
FD130, FD160, FD1100 or FD1200	DPDT	2 NO	First	FD1ASNO11	\$46.00
FD130, FD160, FD1100 or FD1200	DPDT	2 NC	First	FD1ASNC11	\$46.00
FD130, FD160, FD1100 or FD1200	DPDT	2 NO	Second	FD1ASNO22	\$46.00

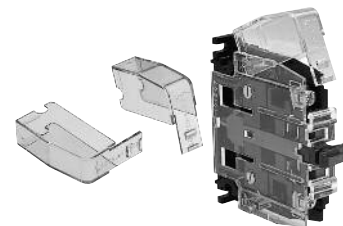

Auxiliary Switch with Terminal Shields



# Disconnect Switches and Operating Mechanisms FD1 Fusible IEC Style (continued)

### Accessories

#### Other Accessories

Accessory Type	Switch Type	Comments	Product Number	List Price GO-139V
Terminal Shields	FD130	Terminal shield for line or load side. One shield supplied with switch as standard.	FD130TS	\$9.00
Terminal Shields	FD160	Terminal shield for line or load side. One shield supplied with switch as standard.	FD160TS	\$14.00
Terminal Shields	FD1100	Terminal shield for line or load side. One shield supplied with switch as standard.	FD1100TS	\$26.00
Terminal Shields	FD1200	Terminal shield for line or load side. One shield supplied with switch as standard.	FD1200TS	\$44.00
Shorting Links	FD130	Package of 3. Use as replacements in FD130NF and FD160NF.	FD130LNK	\$14.00
Shorting Links	FD160	Package of 3. Use as replacements in FD130NF and FD160NF.	FD160LNK	\$14.00
Shorting Links	FD1100	For non-fused applications.	FD1100LNK	\$37.00
Shorting Links	FD1200	For non-fused applications.	FD1200LNK	\$76.00
Fuse Covers	FD130CC FD130NF	-	FD130CV1	\$14.00
Fuse Covers	FD130J	-	FD130JCV1	\$18.00
Fuse Covers	FD160J FD160NF	-	FD160JCV1	\$18.00
Fuse Covers	FD1100	-	FD1100JCV1	\$47.00
Fuse Covers	FD1200	-	FD1200JCV1	\$47.00
Auxiliary Switch Terminal Shields	All	Package of 2.	FD1ASCV1	\$9.00



Terminal Shields

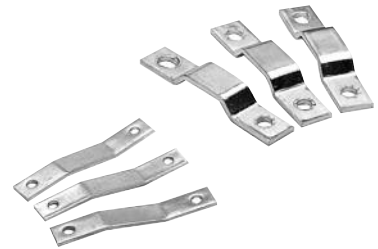

Shorting Links

#### Lug Kits

Type	Description	Product Number	List Price GO-139V
100A	3 mech conn.	FD1LK1	\$56.00
200A	3 mech conn.	FD1LK2	\$118.00

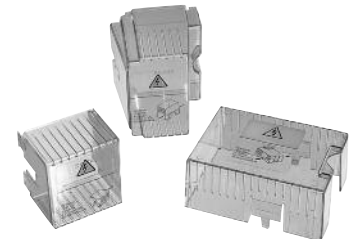

Fuse Covers



Lugs Kits



# Disconnect Switches and Operating Mechanisms

## FD1 Fusible IEC Style

## Section 7

### Outlines and Dimensions

#### Type FD1 Dimension References - in. (mm)

Product Number	Dimension A	Dimension B	Dimension C	Dimension D	Dimension E	Dimension F
FD130CC	4 19/64 (109)	3 23/64 (85)	4 21/64 (110)	3 15/64 (82)	4 13/32 (112)	M4
FD130J	4 19/64 (109)	3 11/32 (85)	4 21/64 (110)	3 15/64 (82)	5 15/64 (133)	M4
FD130NF	4 19/64 (109)	3 23/64 (85)	4 21/64 (110)	3 15/64 (82)	4 13/32 (112)	M4
FD160J	4 41/64 (118)	4 23/32 (120)	5 19/32 (142)	3 15/16 (100)	4 49/64 (121)	M4
FD160NF	4 41/64 (118)	4 23/32 (120)	5 19/32 (142)	3 15/16 (100)	4 49/64 (121)	M4
FD1100J	6 21/32 (169)	6 7/32 (158)	7 11/64 (182)	4 9/64 (105)	4 59/64 (125)	M6
FD1100NF	6 21/32 (169)	6 7/32 (158)	7 11/64 (182)	4 9/64 (105)	4 59/64 (125)	M6
FD1200J	9 27/32 (250)	8 21/32 (220)	9 17/32 (242)	5 29/32 (150)	7 (178)	M8
FD1200NF	9 27/32 (250)	8 21/32 (220)	9 17/32 (242)	5 29/32 (150)	7 (178)	M8

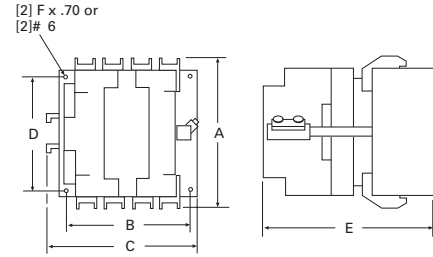

Type FD1

#### Type FD1 — Additional Mechanical Specifications

Product Number	Approx. Net Weight (Lbs.)	Minimum Enclosure Size - Height (in.)	Minimum Enclosure Size - Width	Minimum Enclosure Size - Depth
FD130CC	2.03	9.875	6.875	6.375
FD130J	2.03	9.875	6.875	6.375
FD130NF	1.78	9.875	6.875	6.375
FD160J	2.90	9.875	7.875	6.375
FD160NF	2.52	9.875	7.875	6.375
FD1100J	6.87	15.75	11.50	7.75
FD1100NF	6.82	15.75	11.50	7.75
FD1200J	15.84	15.75	11.50	7.75
FD1200NF	16.39	15.75	11.50	7.75

#### Approvals/Standards

- UL Listed (UL 489)
- CSA Certified (CSA 22.2 No. 4)
- Meets service entrance requirements
- CE Marked





# Disconnect Switches and Operating Mechanisms

## DILOS Nonfusible Vu-Break IEC Style

## Section 7

Individual Components  
480 Vac

### IEC Disconnects — Non Fused

Ampere Rating	No. of Poles	Horsepower 460 Vac	Horsepower 230 Vac	Product Number	List Price GO-139V
30A	3	10	5	D/061312-201	\$122.00
60A	3	15	7.5	D/061314-201	\$147.00
80A	3	20	10	D/061315-201	\$170.00
100A	3	25	15	D/061324-201	\$238.00
125A	3	30	15	D/061326-201	\$265.00

### Ratings Per IEC 947-3

Product Number	Rated Current at 40° C	Rated Current at 50° C	Rated Current at 60° C	Terminal Capacity (CU)	Rated operational voltage Ue
D/061312-201	40 A	40 A	40 A	6 mm <sup>2</sup> Min. 50 mm <sup>2</sup> Max.	690 V
D/061314-201	63 A	63 A	63 A	6 mm <sup>2</sup> Min. 50 mm <sup>2</sup> Max.	690 V
D/061315-201	80 A	80 A	80 A	6 mm <sup>2</sup> Min. 50 mm <sup>2</sup> Max.	690 V
D/061324-201	160 A	160 A	160 A	Copper bus maximum 6 x 20mm	690 V
D/061326-201	200 A	200 A	200 A	Copper bus maximum 6 x 20mm	690 V

### Ratings Per IEC 947-3 (Continued)

Product Number	Rated Insulation Voltage Ui	Rated Impulse Voltage Uimp	Impulse Test Voltage at Sea Level	Rated Operation Current Ie @ Utilization AC21A at Ue=415V	Rated Operation Current Ie @ Utilization AC22a at Ue=415V	Rated Operation Current Ie @ Utilization AC23A at Ue=415V
D/061312-201	690 V	8 kV	12.3 kV	40 A	40 A	40 A
D/061314-201	690 V	8 kV	12.3 kV	63 A	63 A	50 A
D/061315-201	690 V	8 kV	12.3 kV	80 A	80 A	80 A
D/061324-201	690 V	8 kV	12.3 kV	160 A	160 A	125 A
D/061326-201	690 V	8 kV	12.3 kV	200 A	200 A	160 A

### Ratings Per IEC 947-3 (Continued)

Product Product	Rated Short-time Withstand Current Icw, 1 sec.	Rated Short-time Withstand Current Icw, 0.25 sec.	Peak Short-Circuit Withstand Current	Rated Short-circuit Making Capacity Icm, Ue=400V	Rated Short-circuit Making Capacity Icm, Ue=415V
D/061312-201	3 kA rms	6 kA rms	10 kA rms	10 kA	10 kA
D/061314-201	3 kA rms	6 kA rms	10 kA rms	10 kA	10 kA
D/061315-201	3 kA rms	6 kA rms	10 kA rms	10 kA	10 kA
D/061324-201	3 kA rms	6 kA rms	10 kA rms	10 kA	10 kA
D/061326-201	3 kA rms	6 kA rms	10 kA rms	10 kA	10 kA

### Ratings Per IEC 947-3 (Continued)

Product Number	Rated Conditional Short-Circuit Withstand Current @ 400V	Rated Conditional Short-Circuit Withstand Current @ 415V	Rated Operational Current DC23A (2P Series) @ 110V	Rated Operational Current DC23A (2P Series) @ 220V	Electrical Durability	Mechanical Durability
D/061312-201	50 kA rms	50 kA rms	40 A	40 A	1500 Cycles	20000 Cycles
D/061314-201	50 kA rms	50 kA rms	63 A	63 A	1500 Cycles	20000 Cycles
D/061315-201	50 kA rms	50 kA rms	80 A	-	1500 Cycles	20000 Cycles
D/061324-201	50 kA rms	50 kA rms	160 A	100 A	1000 Cycles	10000 Cycles
D/061326-201	50 kA rms	50 kA rms	160 A	100 A	1000 Cycles	10000 Cycles

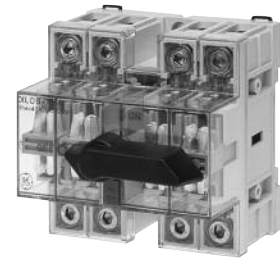

DILOS 1



DILOS 2



# Disconnect Switches and Operating Mechanisms

## DILOS Nonfusible Vu-Break IEC Style

# Section 7

### Accessories

#### Auxiliary Switches

No. of Poles	Comments	Product Number	List Price GO-139V
1	Adds 9mm to width of switch.	D/061901-001	\$68.00
2	Adds 9mm to width of switch.	D/061901-002	\$96.00

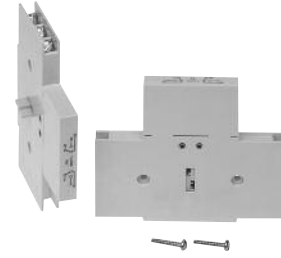

Auxiliary Switches

#### Padlocking Device

Comments	Product Number	List Price GO-139V
For padlock with maximum 8mm or 5/16" diameter.	D/061900-020	\$11.50



Padlocking Device

#### Inbus Key

Shaft Length	Comments	Product Number	List Price GO-139V
200mm	S5 Insulated	D/061000-097	\$15.50



Inbus Key

#### Operating Handle with Extension Shaft – NEMA 1/12

Shaft Length	Handle Color	Product Number	List Price GO-139V
200mm	Black	D/061910-002	\$52.00
200mm	Red/Yellow	D/061910-012	\$54.00
400mm	Black	D/061910-004	\$58.00
400mm	Red/Yellow	D/061910-014	\$61.00



Operating Handle with Extension Shaft

#### Lugs

Wire Size	Comments	Product Number	List Price GO-139V
#8-250 kcmil CU	Package of 3	D/061922-003	\$42.00

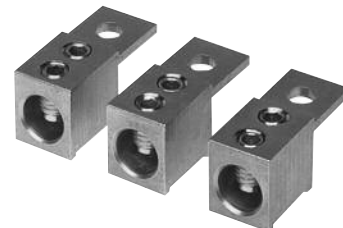

Lugs



# Disconnect Switches and Operating Mechanisms

## DILOS Nonfusible Vu-Break IEC Style

# Section 7

Outlines and Dimensions

### DILOS – Weights

Product Number	Weight (Lbs.)	Weight (kg)
D/061312-201	1.2	0.54 kg
D/061314-201	1.2	0.54 kg
D/061315-201	1.2	0.54 kg
D/061324-201	1.6	0.73 kg
D/061326-201	1.6	0.73 kg

### Approvals/Standards

UL Listed (UL 489)  
IEC 947-1, 947-3  
EN 60947-3

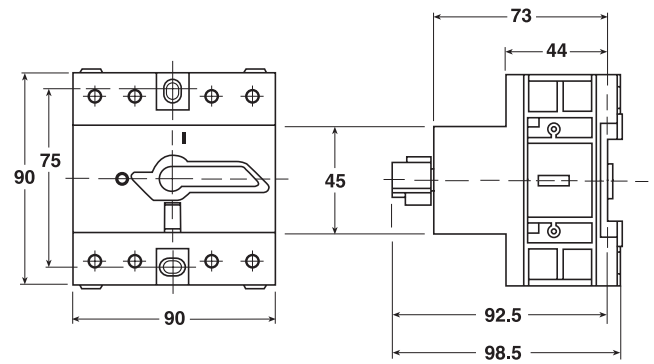

DILOS 1

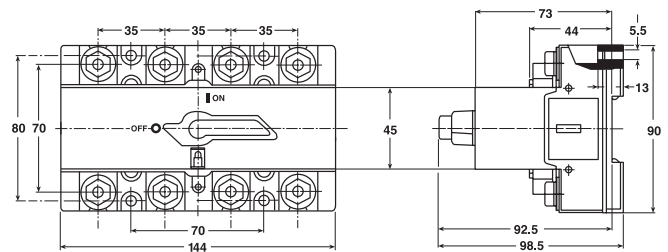

DILOS 2



