

Power Amplifier

EEA-PAM-5**-A-32 for Proportional Control Valves

Contents

The following power amplifier models are covered in this catalog

Power Amplifier	For Proportional Valve
EEA-PAM-513-A-32	KCG-3, 1* series KCG-6/8, 1* series KX(C)G-6/8, 1* series
EEA-PAM-523-A-32	KTG4V-3...H*, 6* series KDG4V-3...H*, 6* series KDG5V-5/7/8, 1* series
EEA-PAM-525-A-32	KTG4V-5...H*, 3* series KDG4V-5...H*, 3* series
EEA-PAM-533-A-32	KFTG4V-3, 2* series KFDG4V-3, 2* series
EEA-PAM-535-A-32	KFTG4V-5, 2* series KFDG4V-5, 2* series
EEA-PAM-541-A-32	KHDG5V-5/7/8, 2* series With zero-lapped main spool
EEA-PAM-553-A-32	KSDG4V-3, 1* series
EEA-PAM-561-A-32	KFDG5V-5, 3* series KFDG5V-7, 1* series
EEA-PAM-568-A-32	KFDG5V-8, 1* series
EEA-PAM-571-A-32	CVU-**-EFP1-3*
EEA-PAM-581-A-32	KHDG5V-5/7/8, 2* series

General Description

The power amplifier has five voltage inputs (one inverting) and a current input for 0-20 mA. Adjustments for set zero point or deadband compensation and for gain allow the amplifier to be easily tuned to the proportional control valve. The ramp function generator can be switched on and off using the "ramp enable" control.

Monitor points on the front panel allow measurement of the conditioned command signal, and either of spool position LVDT signal or (for valves without LVDT) of solenoid current. ("Conditioned command signal" is the input signal modified according to settings of set zero point or deadband compensation, gain and ramp functions.)

Features

- User-friendly front panel with all the necessary adjustments, LEDs and monitor points
- Electronic overload protection with automatic reset
- Pulse width modulation for high efficiency
- Can be equipped with plug-in modules for special functions
- Switchable ramp function generator for controlling rates of increase and decrease of output
- 24V DC power supply
- Either current or voltage input signals
- Standard input and output signals



This product has been designed and tested to meet specific standards outlined in the European Electromagnetic Compatibility Directive (EMC) 89/336/EEC, amended by 91/263/EEC, 92/31/EEC and 93/68/EEC, article 5. For instructions on installation requirements to achieve effective protection levels, see this leaflet and the Installation Wiring Practices for Vickers Electronic Products leaflet 2468. Wiring practices relevant to this Directive are indicated by  Electromagnetic Compatibility (EMC).

Front Panel

Model

523, 525, 533, 535, 561, 568 and 581

LEDs

- [1] 24V supply voltage, green
- [2] 15V control voltage, green
- [3] Solenoid output enabled, yellow
- [4] Solenoid output overload, red
- [5] LVDT failure, red
- [6] Drive to solenoid, yellow

Potentiometers

- [7] Deadband compensation, flow from P to B
- [8] Deadband compensation, flow from P to A
- [9] Gain, flow from P to B
- [10] Gain, flow from P to A

LED

- [11] Ramps enabled, yellow

Potentiometers

- [12] Acceleration ramp
- [13] Deceleration ramp

Monitor points ▲

- [14] Conditioned command signal MP1
- [15] Common ground 0V
- [16] Spool position MP2
(except for 523/525: solenoid current)

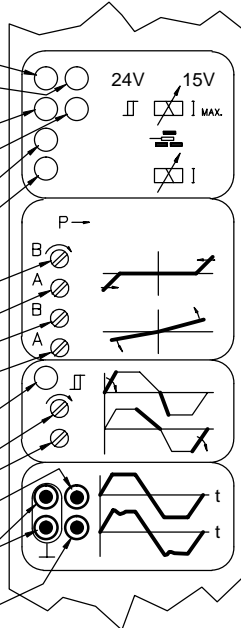

513

Potentiometers

- [17] Zero adjust
- [18] Gain

Monitor point ▲

- [19] Solenoid current MP2

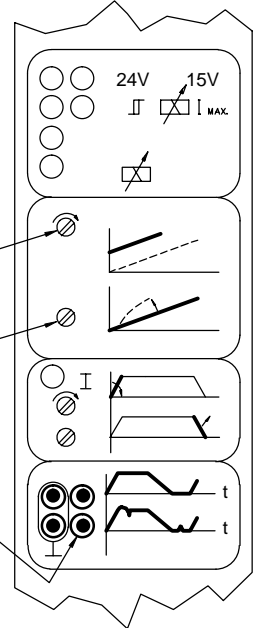

541, 553

Potentiometer

- [20] Adjust valve zero

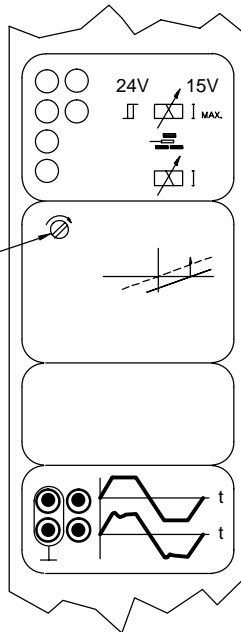

571

Potentiometers

- [21] Deadband compensation
- [22] Gain

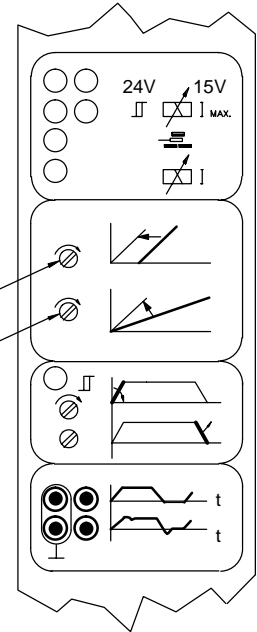

▲ Ø 2 mm (0.0787" dia.) sockets



Warning: Electromagnetic Compatibility (EMC)

It is necessary to ensure that the unit is wired up in accordance with the connection arrangements shown in this leaflet. For effective protection, the user's electrical cabinet, the valve subplate or manifold and the cable screens should be connected to efficient earth (ground) points. The metal 7-pin connector part no. 934939 should be used for the integral amplifier.

In all cases, both valve and cable should be kept as far away as possible from any source of electromagnetic radiation such as cables carrying heavy current, relays and certain kinds of portable radio transmitters, etc. Difficult environments could mean that extra screening may be necessary to avoid the interference.

Electrical Block Diagram

EEA-PAM-523/525-A-32

533/535
561/568
571
581

Note: This is a typical diagram and all the features depicted may not be applicable to all amplifiers, (e.g. LVDTs and dither)

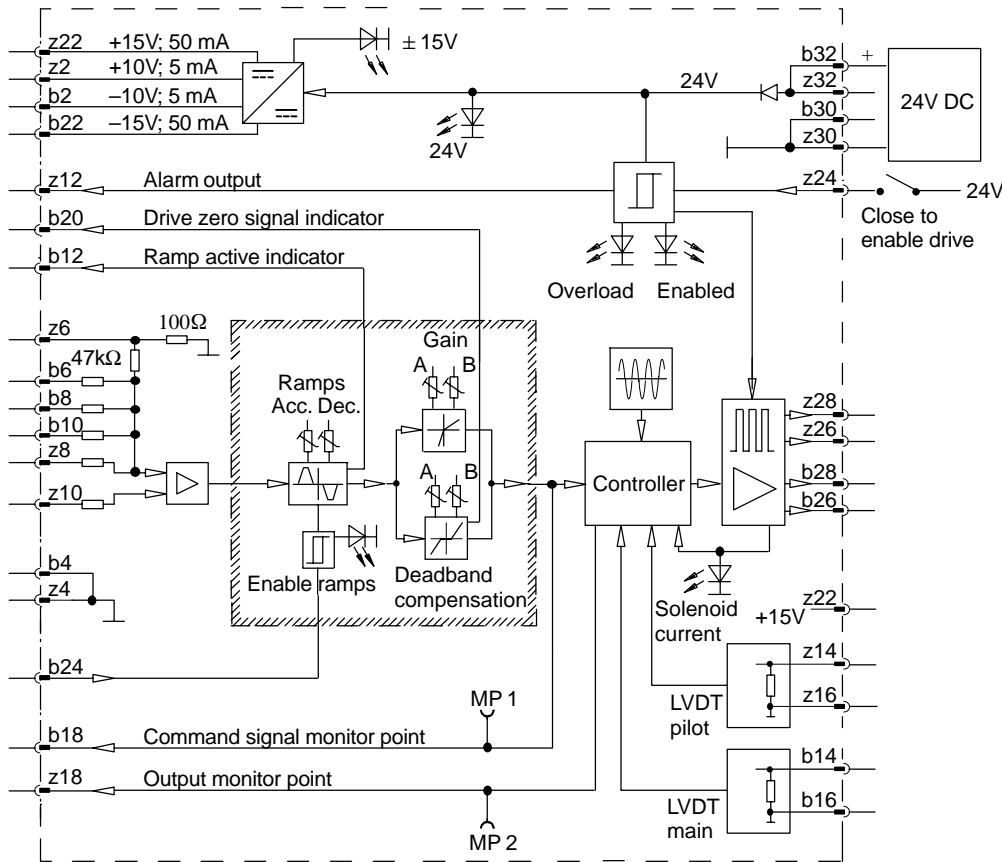

EEA-PAM-513-A-32

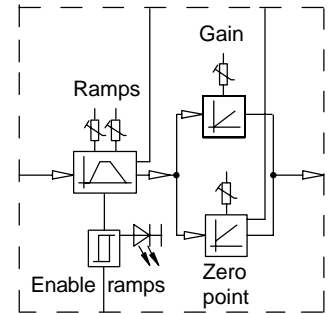



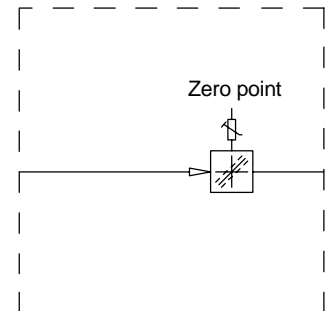















EEA-PAM-541-A-32 553

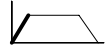
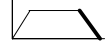
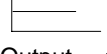
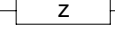

Command signals and outputs				All models except 553 and 571	553	571
Non-inverting voltage b6/8/10 or z8	Non-inverting current z6	Inverting voltage z10	Secondary pins	Output		
-			bz4	P to A	P to B	Valve closed
	-		bz4			
		+	bz4			
-		+	N/A	P to B	P to A	A to B and B to A
+			bz4			
	+		bz4			
+		-	bz4			
		-	N/A			

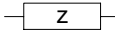
Operating Data

Power supply: Nominal $V_{min.} - V_{max.}$ Amplifier shut-down Protection	24V DC x 50W 20 - 40V (incl. pk.-to-pk. ripple $\pm 10\%$ max.) <18V DC Reverse-polarity
Signal sources: —○ z22 & b22 —○ z2 & b2 Temperature drift	$\pm 15V \times 50 \text{ mA max. (pk.-to-pk. ripple 50 mV)}$ $\pm 10V (\pm 1\%) \times 5 \text{ mA max. (pk.-to-pk. ripple 20 mV)}$ $< 1 \text{ mV/}^\circ\text{C} (< 0,5 \text{ mV/}^\circ\text{F}) \text{ } 0\text{-}50^\circ\text{C} (32 - 122^\circ\text{F})$ All outputs short-circuit protected
Command inputs Voltage: Direct-V Inverting-V $U_{min.} - U_{max.}$ Input  — Current —○ z6: Range, I Input  —	—○ b8, b6, z8 & b10 —○ z10 $0 \pm 10V$ $47 \text{ k}\Omega$ $0 \pm 20 \text{ mA}$ 100Ω
Power drive	 = PWM short-circuit protected
Max. solenoid current	See table on next page
Current at zero (0V command signal on MP1)	See table on next page
Dither	Factory-set
Deadband compensation	See table on next page
Gain	See table on next page
Ramp-time adjustment: Factory setting  \nearrow min. - max.  \nearrow min. - max.	Min. $\approx 50 \text{ ms}$ $50 \text{ ms} - 5\text{s}$ $50 \text{ ms} - 5\text{s}$
Overload detection	Automatic reset
Drive: Enabled —○ z24 Disabled —○ z24 Input  —	$> 9,8 - < 40V$ Open circuit or $\leq 4,5V$ $22 \text{ k}\Omega$
Ramps: Enabled —○ b24 Disabled —○ b24 Input  —	$> 9,8 - < 40V$ Open circuit or $\leq 4,5V$ $22 \text{ k}\Omega$
Command signal monitor point: Front-panel  MP1 & —○ b18 Output  —	Monitor signal after deadband compensation (minimum setting), gain and ramps: $0 - 10V (10V \triangleq I_{max.})$ $10 \text{ k}\Omega$ short-circuit protected
Output monitor point  : Front panel  MP2 & —○ z18 Output  —	$513/523/525$ (without LVDT): 1 V/A Other types (with LVDT): $\pm 10V$ at full stroke $10 \text{ k}\Omega$ short-circuit protected

Ramp-active indicator  b12    Output  z	Output > + 10V Output < - 10V Output = 0V (±2V ripple) 10 kΩ
Drive signal zero indicator  b20 Drive signal at null (within deadband limits) Drive active Output resistance  z	Output = Supply minus 1,5V; I = 50 mA max. Output = 0 ± 2V 50Ω
Alarm output  z12 Set alarm Signal Reset after failure	Enable amplifier (on pin z24) when switching power on HIGH when alarm is activated: Output = Supply volts minus 2 volts; I = 50 mA max. LOW when solenoid overload has occurred (maintained until reset): Output = 0 to +/-2 volts; Output impedance = 50Ω Disable and re-enable on pin z24
Ambient temperature range	0 - 50°C (32 - 122°F) full specification
Edge connectors DIN 41612	 F48 on board for card holder  F32 or F48
	330g (0.15 lb)
Installation recommendations leaflet, packed with amplifier	ML-9160
Supporting products (see appropriate catalog):	
Power supply	3,5A EHA-PSU-704-A3-20 5,0A EHA-PSU-704-A5-20 10,0A EHA-PSU-704-A10-20
Test adaptor	EBA-TEQ-706-A-10
Portable test equipment	EHA-TEQ-700-A-20 EBA-TEQ-706-A-10
Cardholder	D32 02-104806 F32 02-104807 F48 02-104808
Edge connector	F48 732683

Model	513	523 525	533	535	541	553	561 568	571	581
Max. solenoid current	1,6A	1,6A	2,7A	2,7A	3,2A	3,2A	1,8A	2,9A	3,2A
Amplifier input current at 0V command signal (MP1)	0,3A	0,3A	0,3A	0,3A	1,7A	1,7A	1,4A	1,1A	1,7A
Deadband compensation									
Factory setting (% of max. spool stroke)	-	25%	15%	10%	-	-	10%	10%	10%
Adjustment per direction (% of max. spool stroke from centered position)	-	0 - 50%	0 - 50%	0 - 50%	-	-	0 - 50%	0 - 50%	0 - 50%
Gain									
Factory setting	10%/V	10%/V	10%/V	10%/V	10%/V	10%/V	10%/V	10%/V	10%/V
Adjustment per direction	2,5 - 10%/V	2,5 - 10%/V	2,5 - 10%/V	2,5 - 10%/V	-	-	2,5 - 10%/V	2,5 - 10%/V	2,5 - 10%/V
Zero adjustment (% of max. spool stroke)	0 - 50%	-	-	-	+/- 25%	+/- 25%	-	-	-

Wiring Connections

Amplifier Models to Typical Valve Type

Amplifier Models: 513, 523, 525

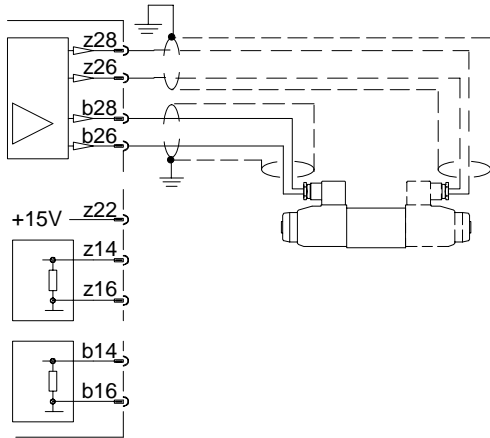

Amplifier Models: 533, 535

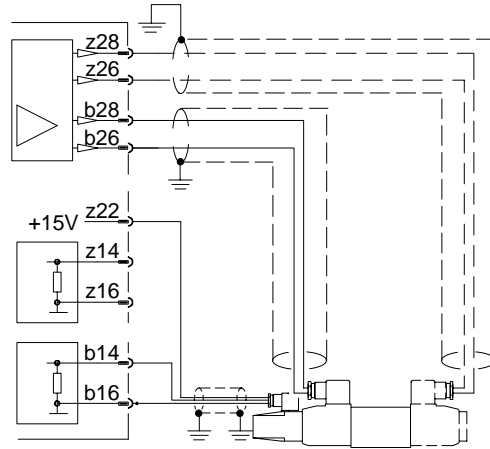

Amplifier Model: 553

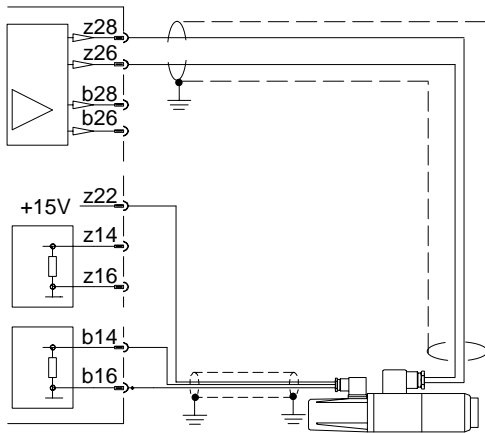

Amplifier Models: 561, 568

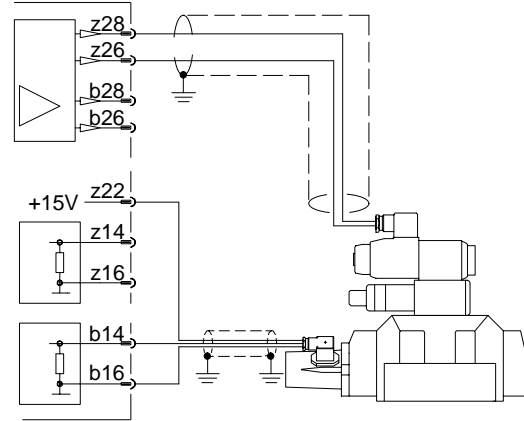

Amplifier Models: 541, 581

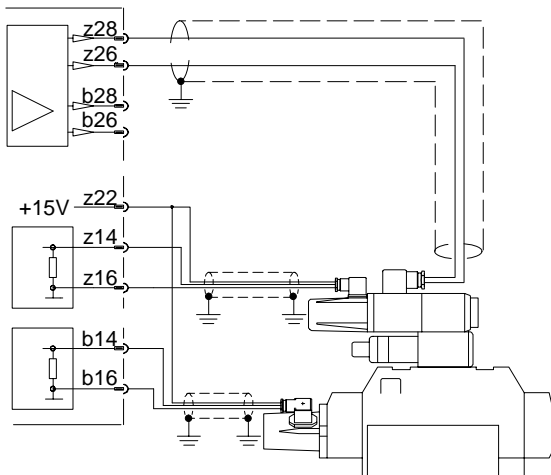

Amplifier Model: 571

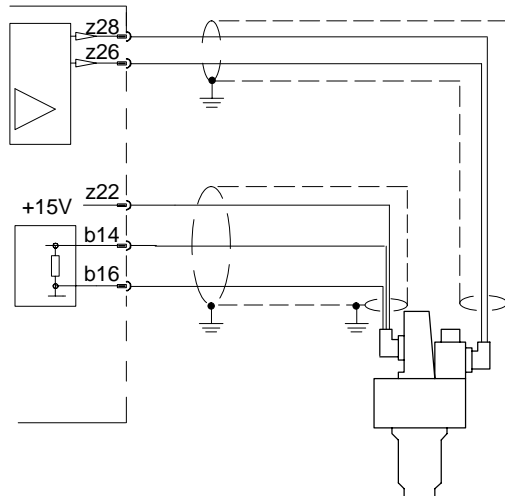

 Customer's protective ground connection.

Note: If valves are fitted with the "B" type LVDT, the screen will be grounded at the valve end by the shell of the connector.

Typical Input Connection Circuitry

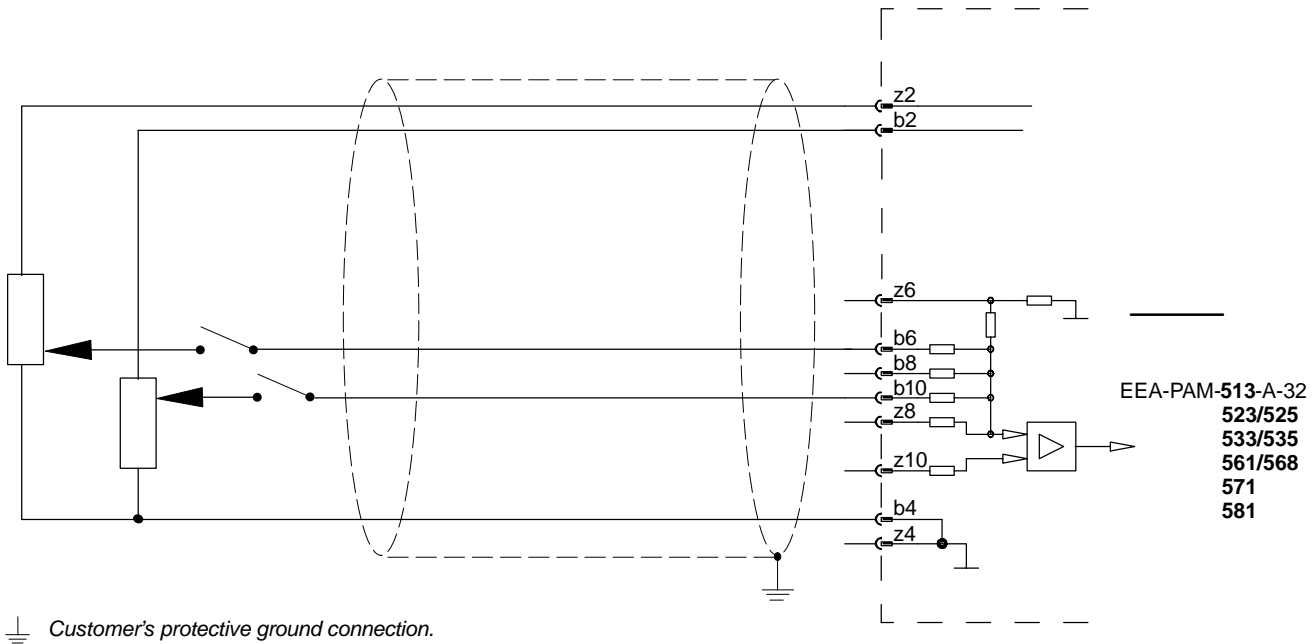

Valve Solenoid Connections

Note: Connection not polarity sensitive.

z26/28 (b26/28)

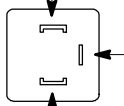

z28/26 (b28/26)

Protective ground: Connection not required if power supply conforms to VDE 0551/EN 60742/IEC 742

LVDT Connections

M & E Type

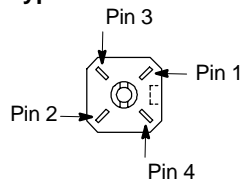

B Type (EMC)

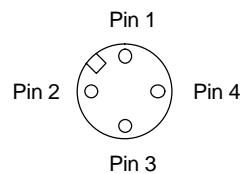

	LVDT plug pin	Amplifier pin
Pilot stage	1	z14
	2	z22
	3	z16
	4	Not connected
Main stage +CVU-EFP1	1	b14
	2	z22
	3	b16
	4	Not connected



Electromagnetic Compatibility (EMC)

Notes for Wiring

- 1) Screened cables should be used for the command signals, the solenoid connections and the LVDT connections.
- 2) Particular attention should be paid to the grounding of the screens as shown in the diagrams.
- 3) The screen on the LVDT cable needs to be grounded at both ends. An alternative method to prevent creating earth loops is to use double screened cable with each screen grounded at opposite ends.
- 4) The amplifiers should be mounted in a metal enclosure which is connected to an efficient ground point.

Installation Dimensions in mm (inches)

Plug-in Unit of 3U Height (IEC 297)

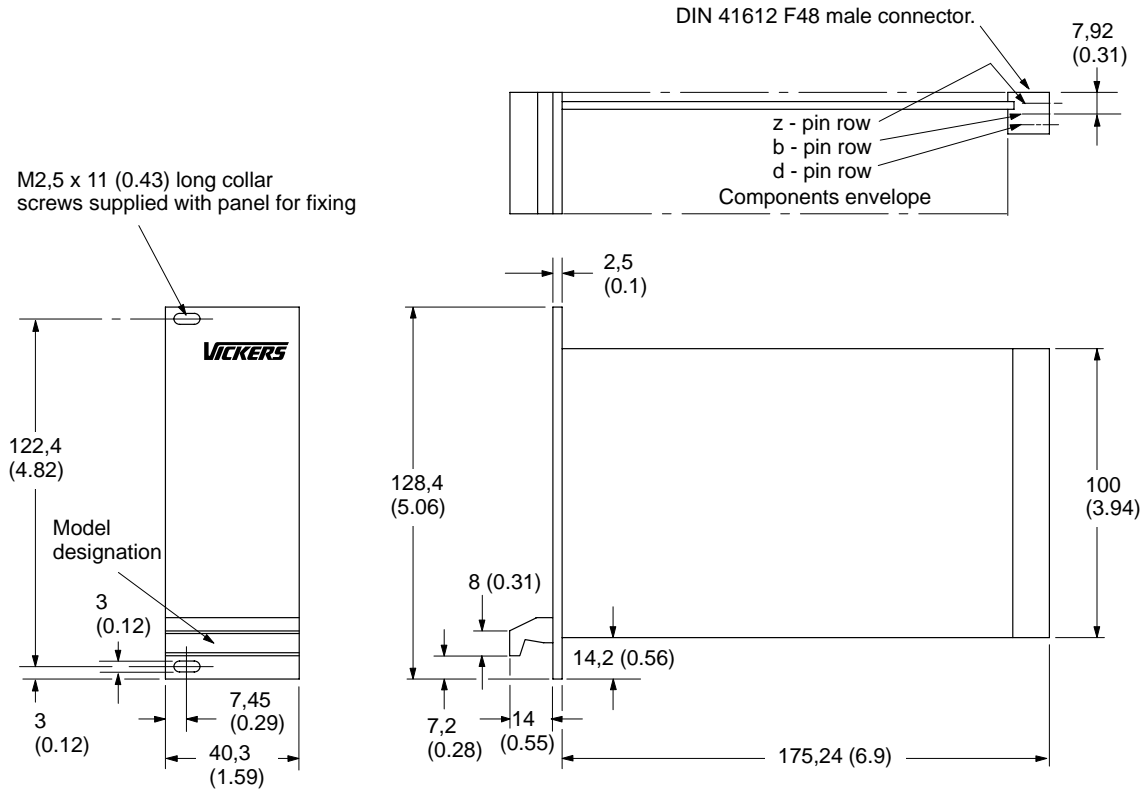
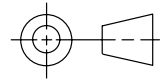

Vickers Systems Division
TRINOVA Ltd
P.O. Box 4
New Lane, Havant
Hampshire PO9 2NB
England

Trinova do Brazil S.A.
CEP 07250-270
Av. Julia Gaioli, 450
Bonsucesso—Guarulhos
Sao Paulo 07
Brazil

Vickers Systems Ltd
2/F Chiaphua Centre
Yuen Shun Circuit
Siu Lek Yuen, Shatin
N.T. Hong Kong

Vickers, Incorporated
5445 Corporate Drive
P.O. Box 302
Troy, Michigan
48007-0302
USA